

Copyright by Firas Abu Jaber

Ford Mustang Shelby GT500



Instructions by
BISSI



Design by
BRICKS GARAGE
by Firas Abu-Jaber

Build the alternative model, the Ford Mustang Shelby GT500, with the same parts inside of the original LEGO set 10265 Ford Mustang.

Hope you like it and thanks for looking 😊

Model's Author: Firas Abu-Jaber



BRICKS GARAGE

by Firas Abu-Jaber

Instructions's Author: Simone Bissi

BISSI



**Warning! Choking hazard. Small parts.
Attenzione! Rischio di soffocamento. Piccole parti.
¡Atención! Riesgo de asfixia. Pequeñas piezas.**

These instruction manuals are for personal use. You must not publish or sell them.

LEGO® is registered trademark of The LEGO® Group, Copyright 2019, which does not sponsor, authorize, or endorse this publication in any manner. All rights reserved. All trademarks in this publication are the property of their respective owners and licensees. All text, pictures and schemes are the property of the author. Nothing in this book may be reproduced in whole or in part without the permission of the author. All rights reserved.

BUILDING

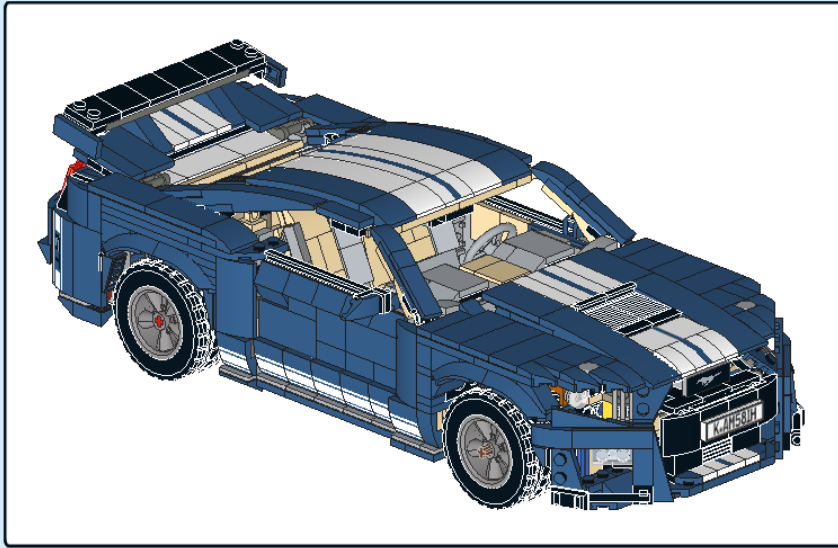

1

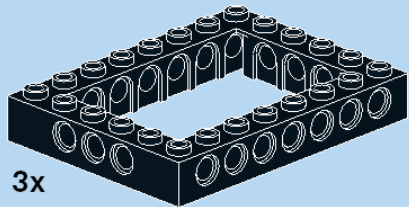

3x



4x

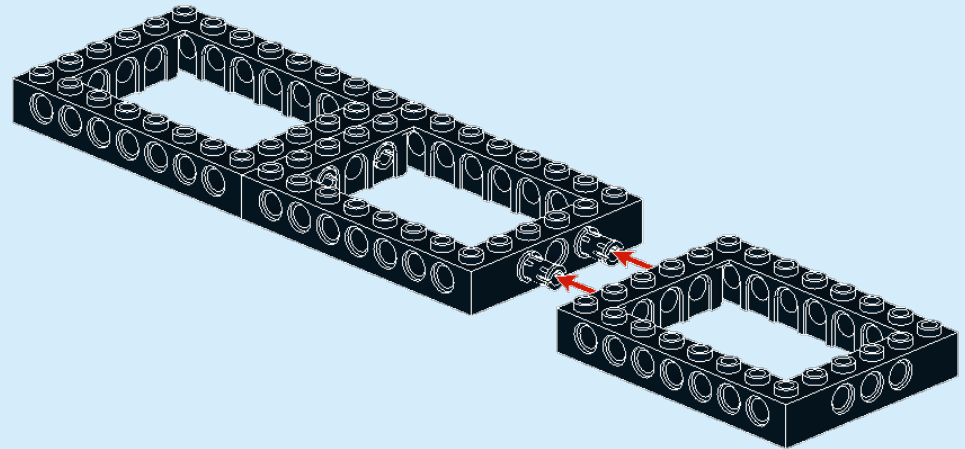

2

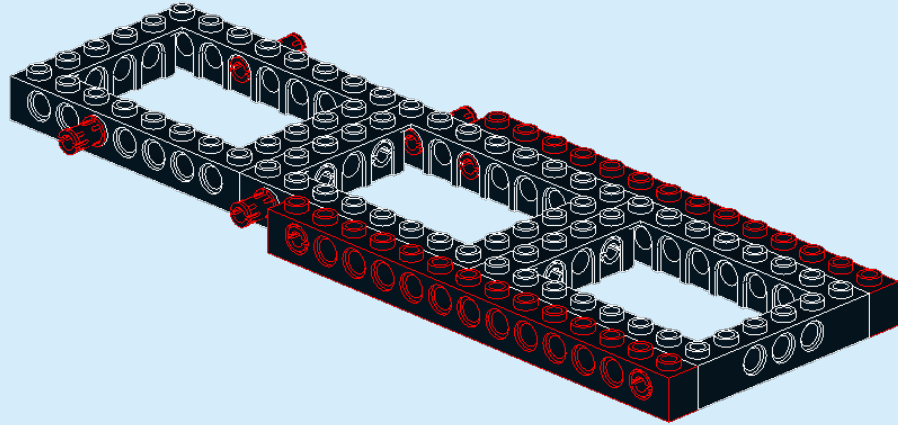
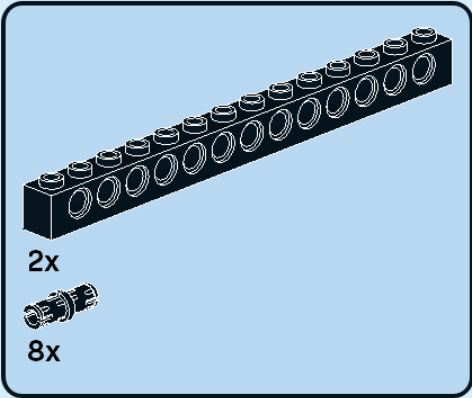

3

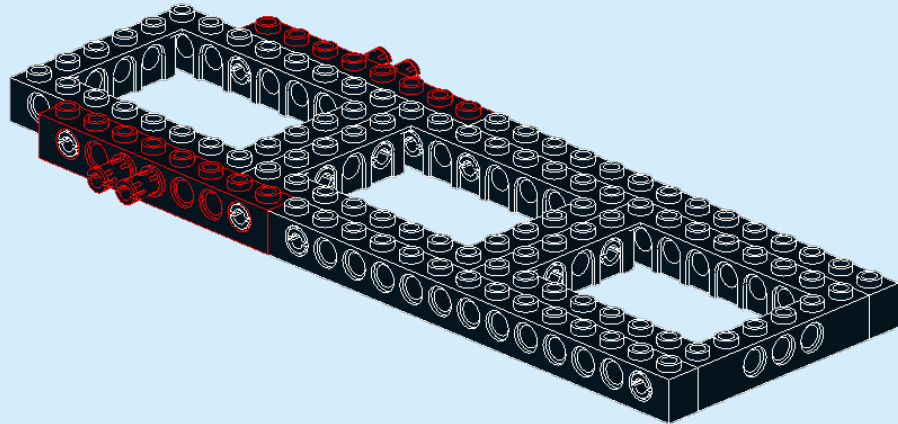
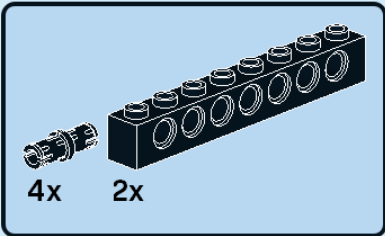

4

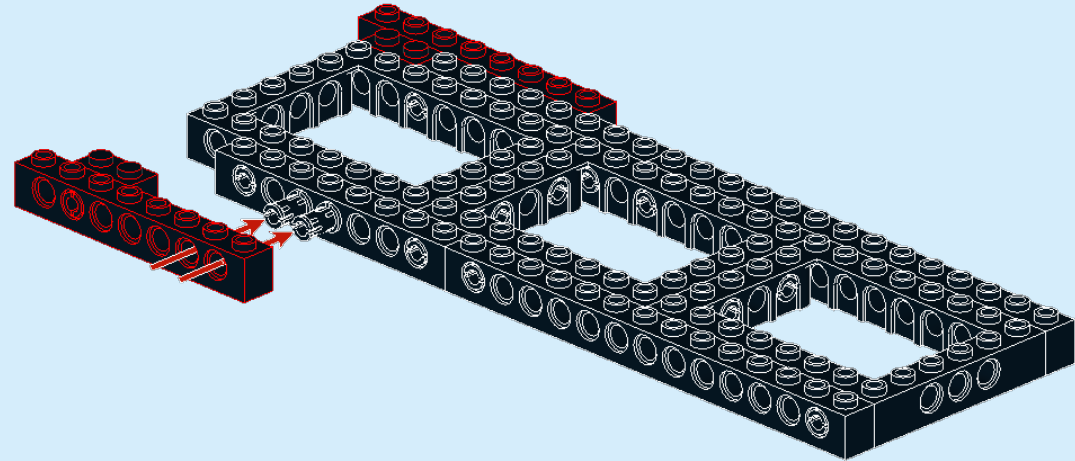
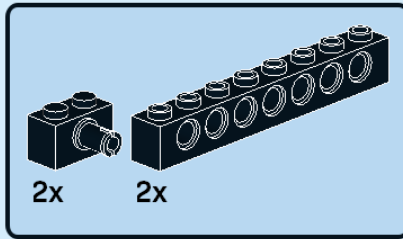

5

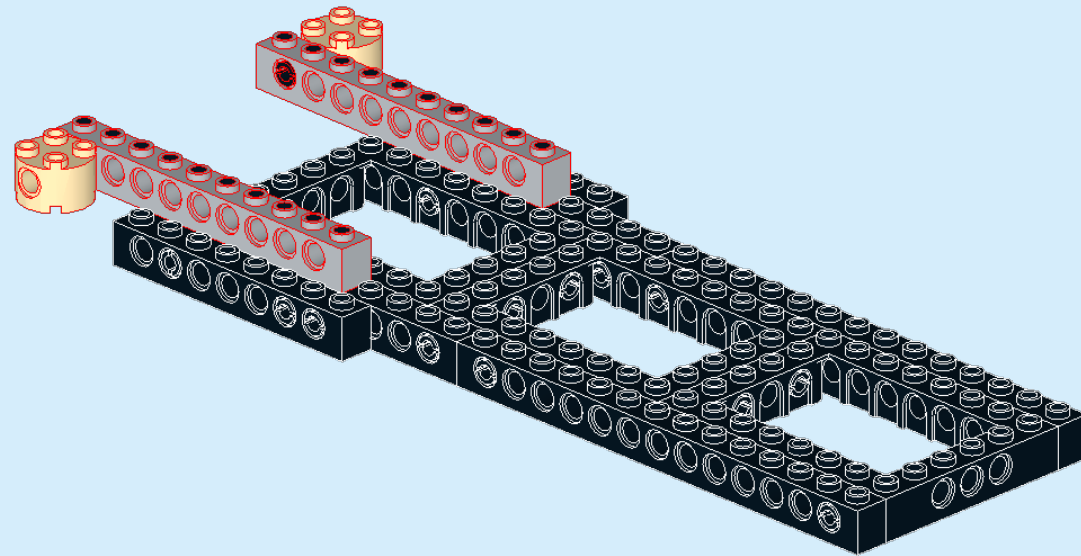
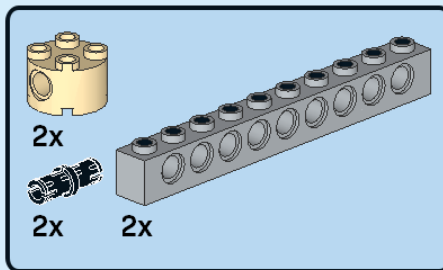

6

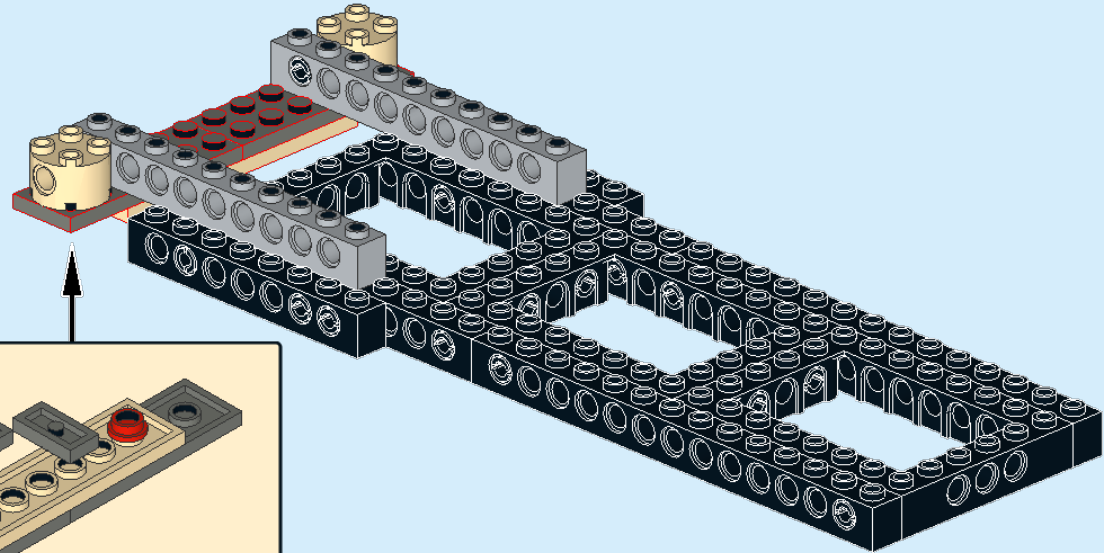
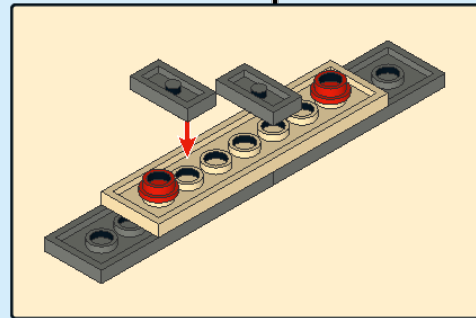
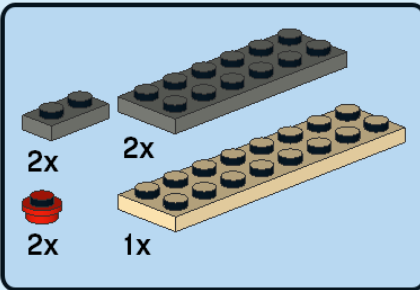

7

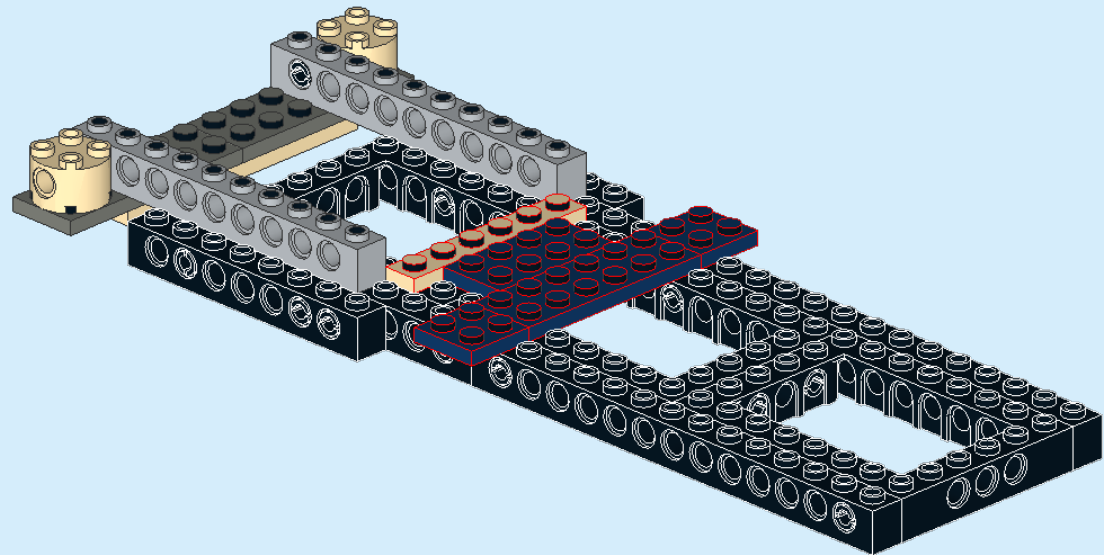
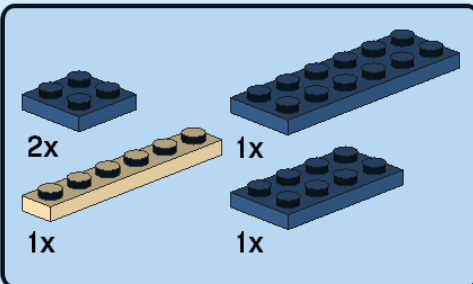

8

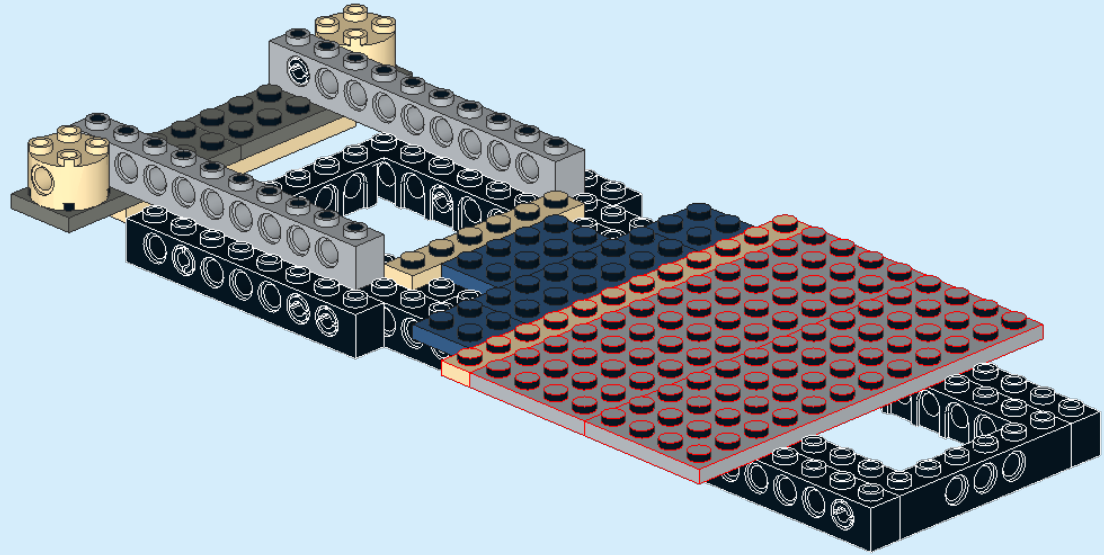
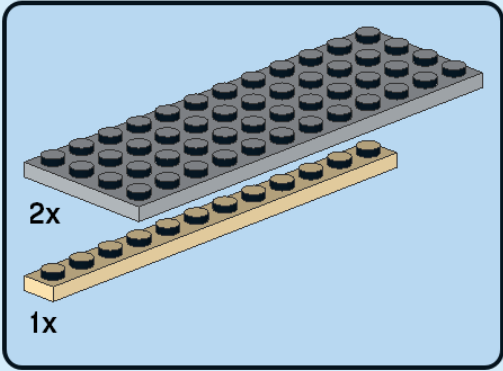

9

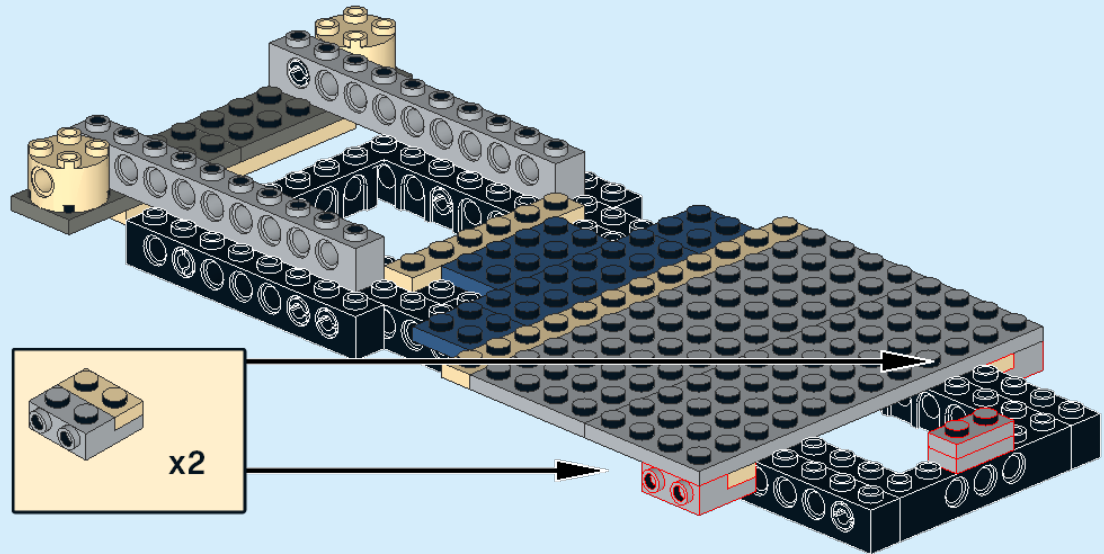
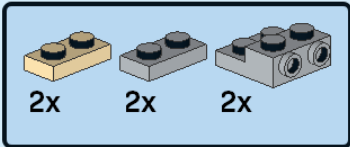

10

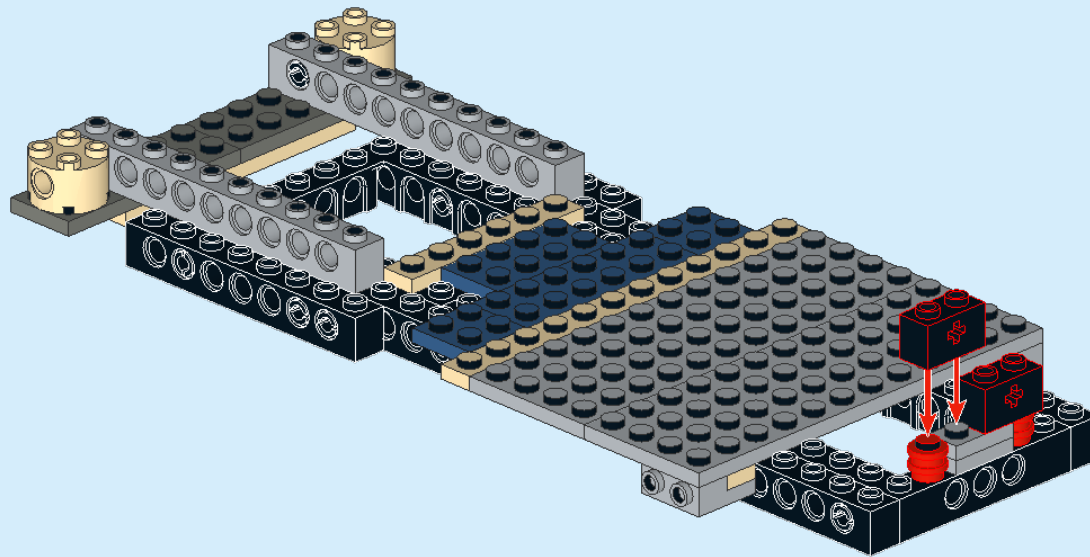
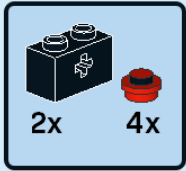

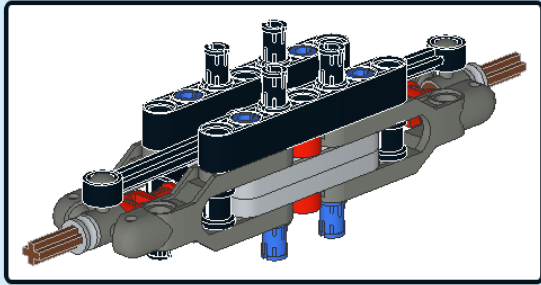

1

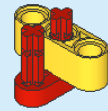
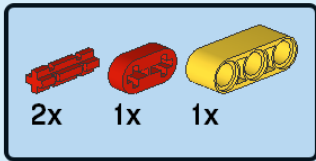

2

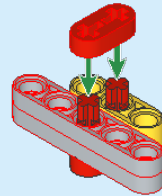
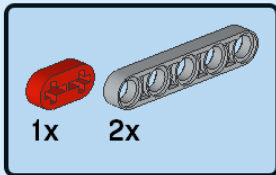

3

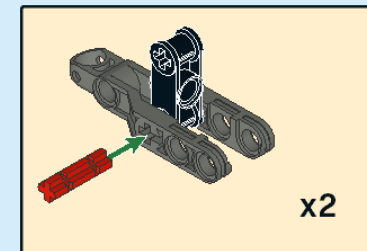
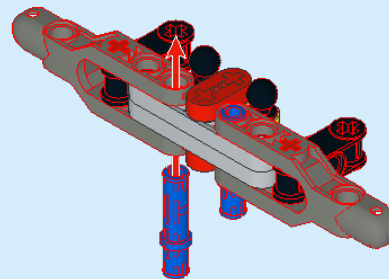
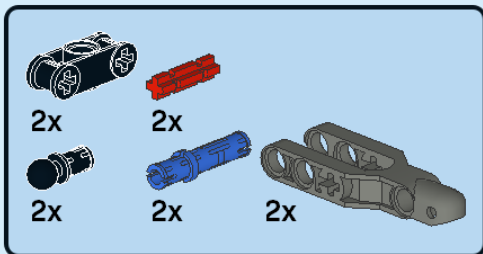

4

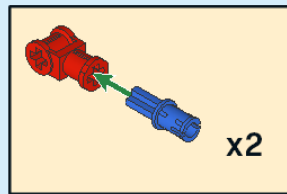
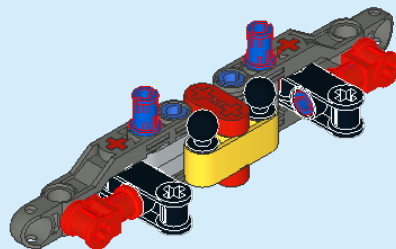
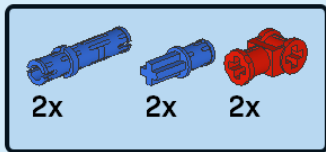

5

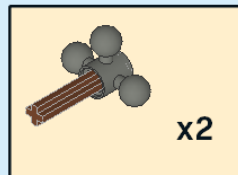
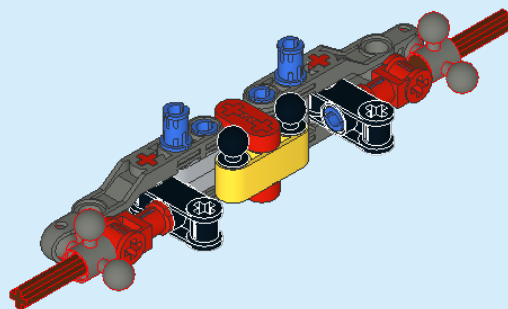
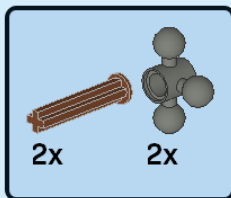

6

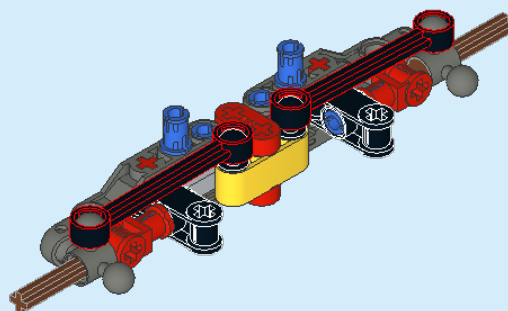
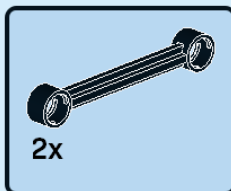

7

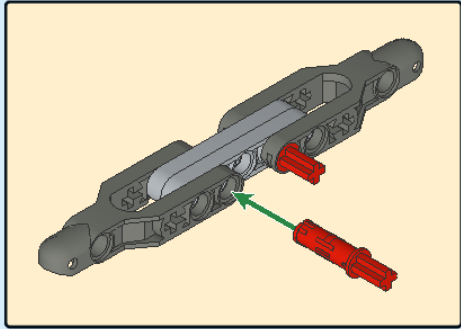
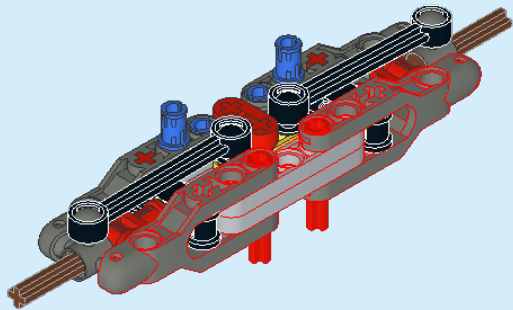
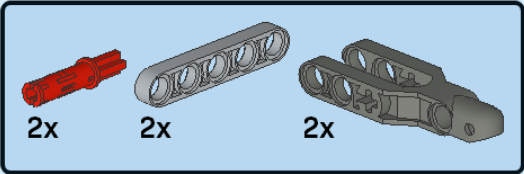

8

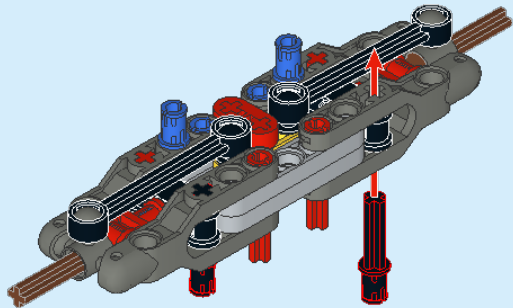

9

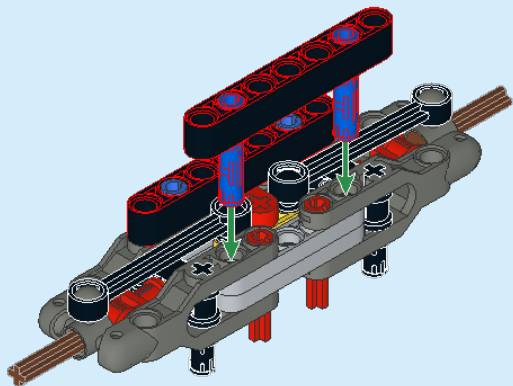
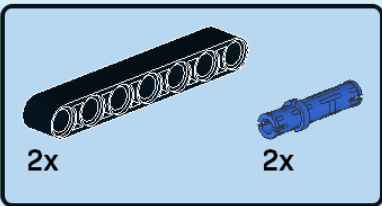

10

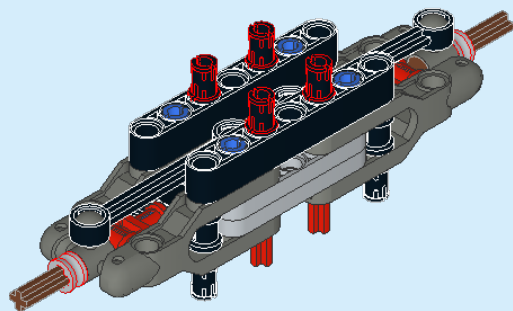

11

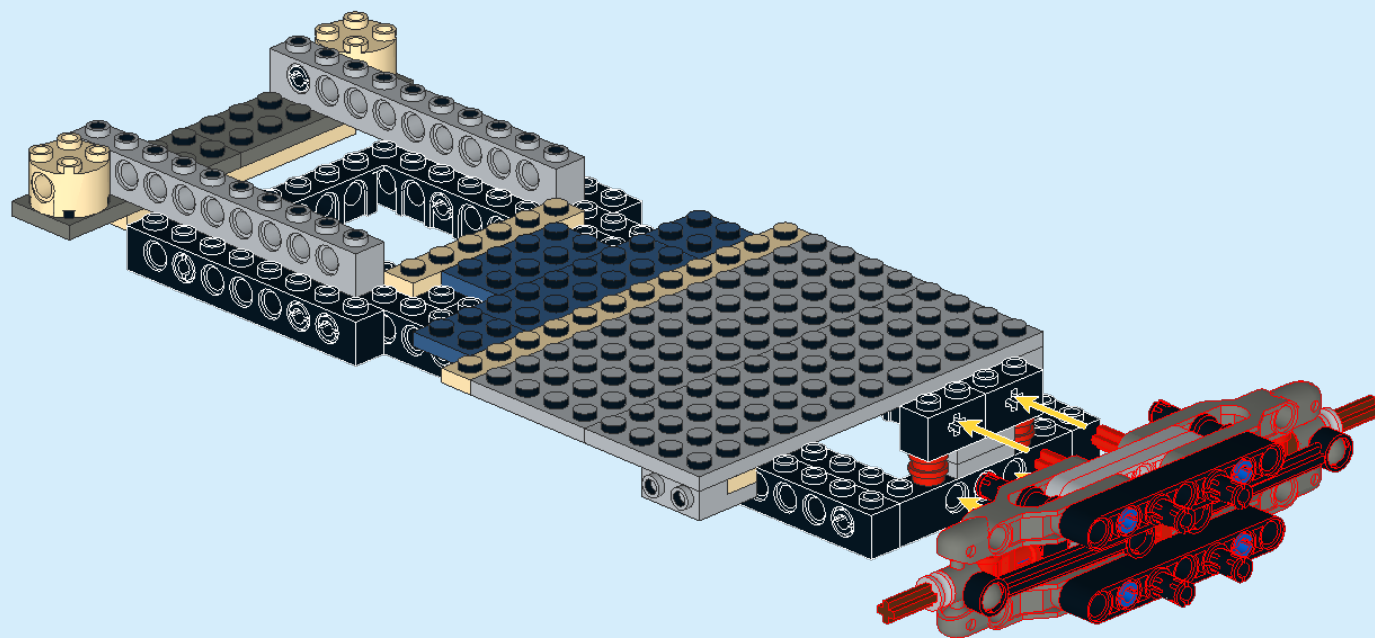

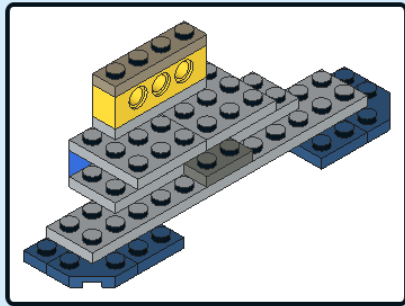

1

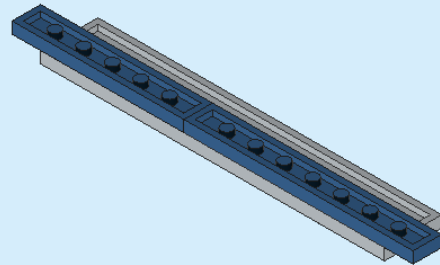
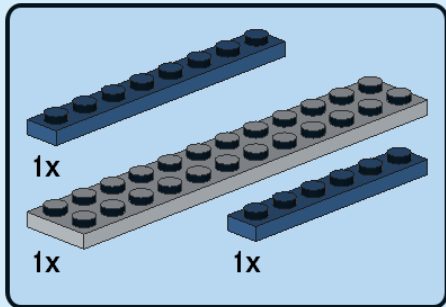

2

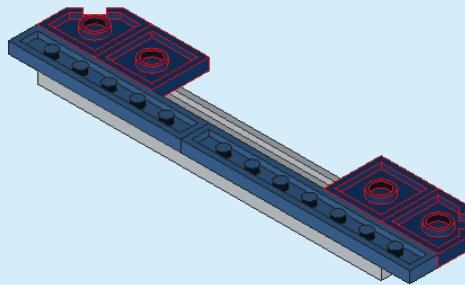
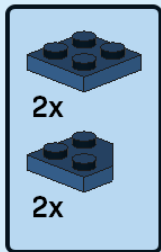

3

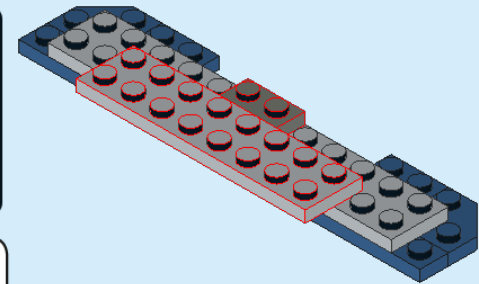
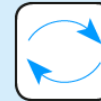
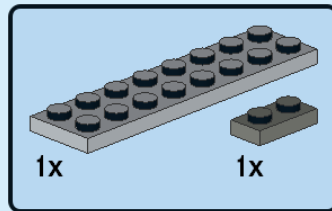

4

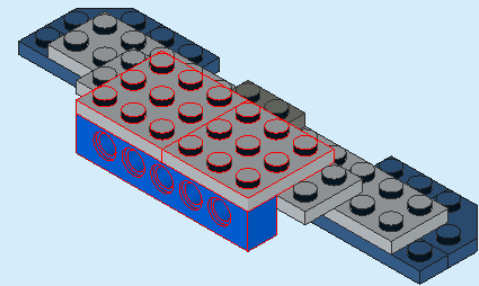
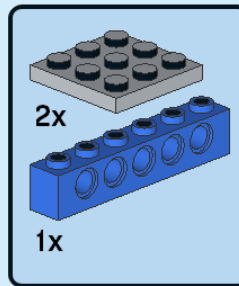

5

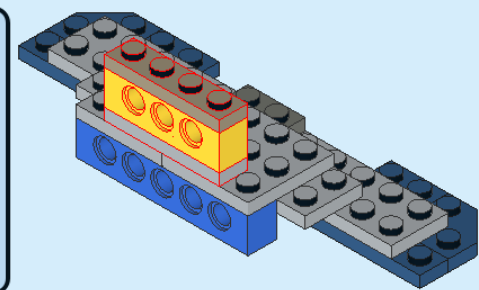
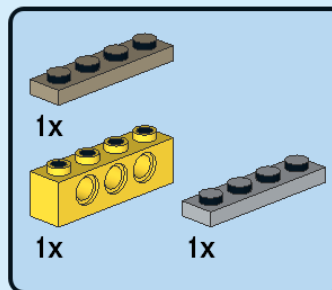

12

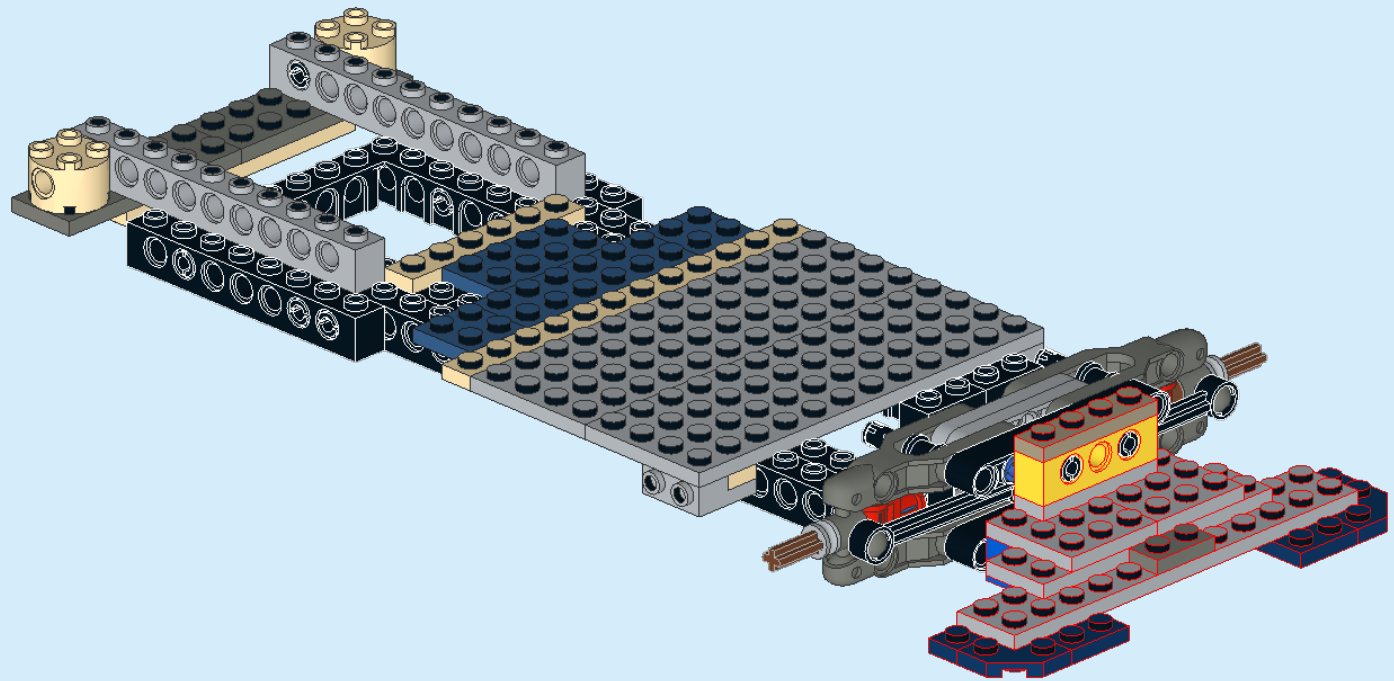

13

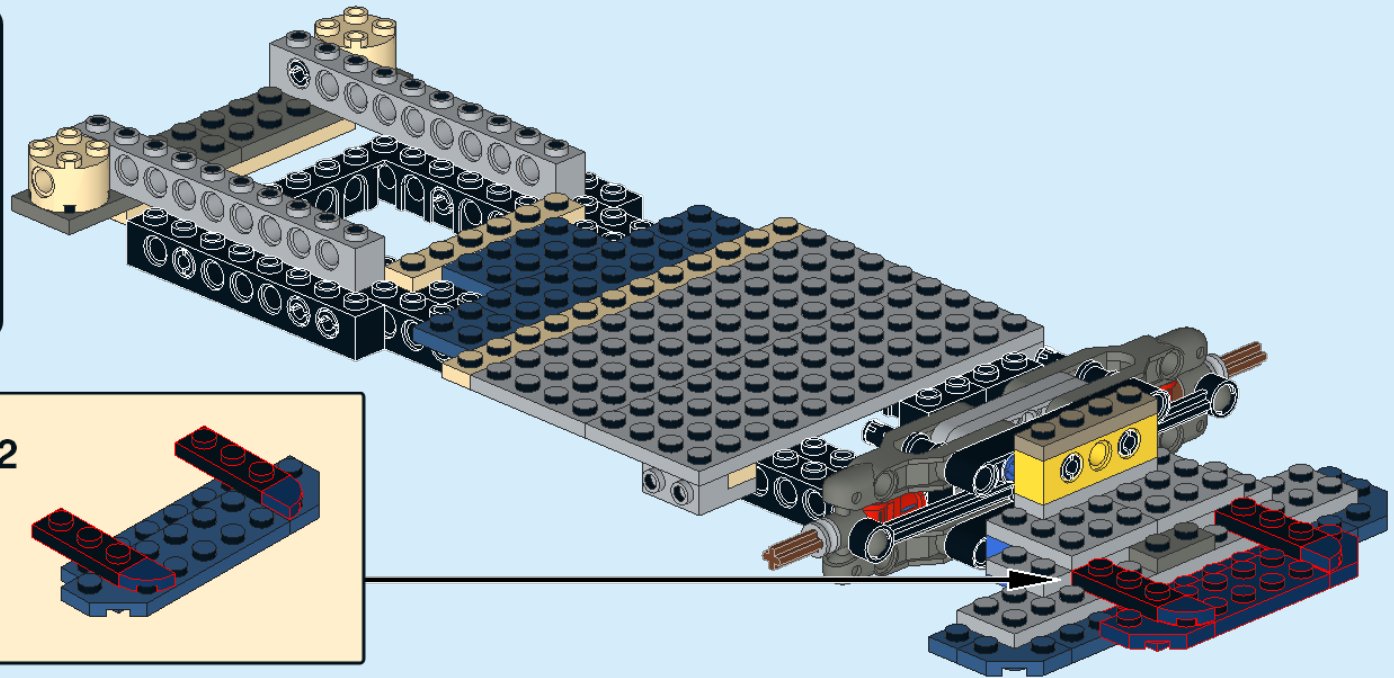
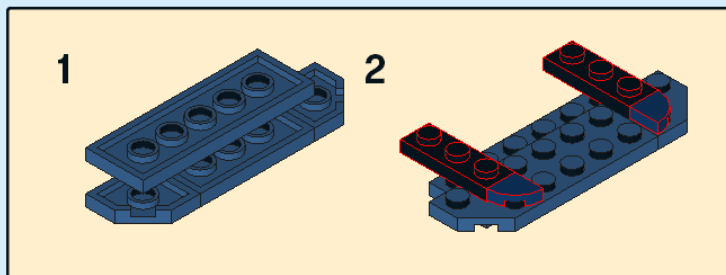
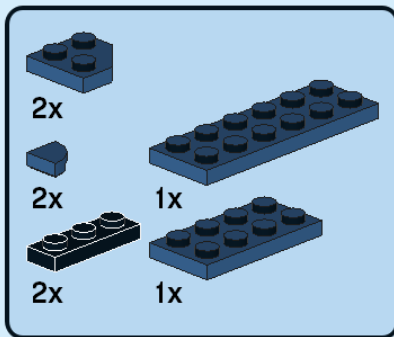

14

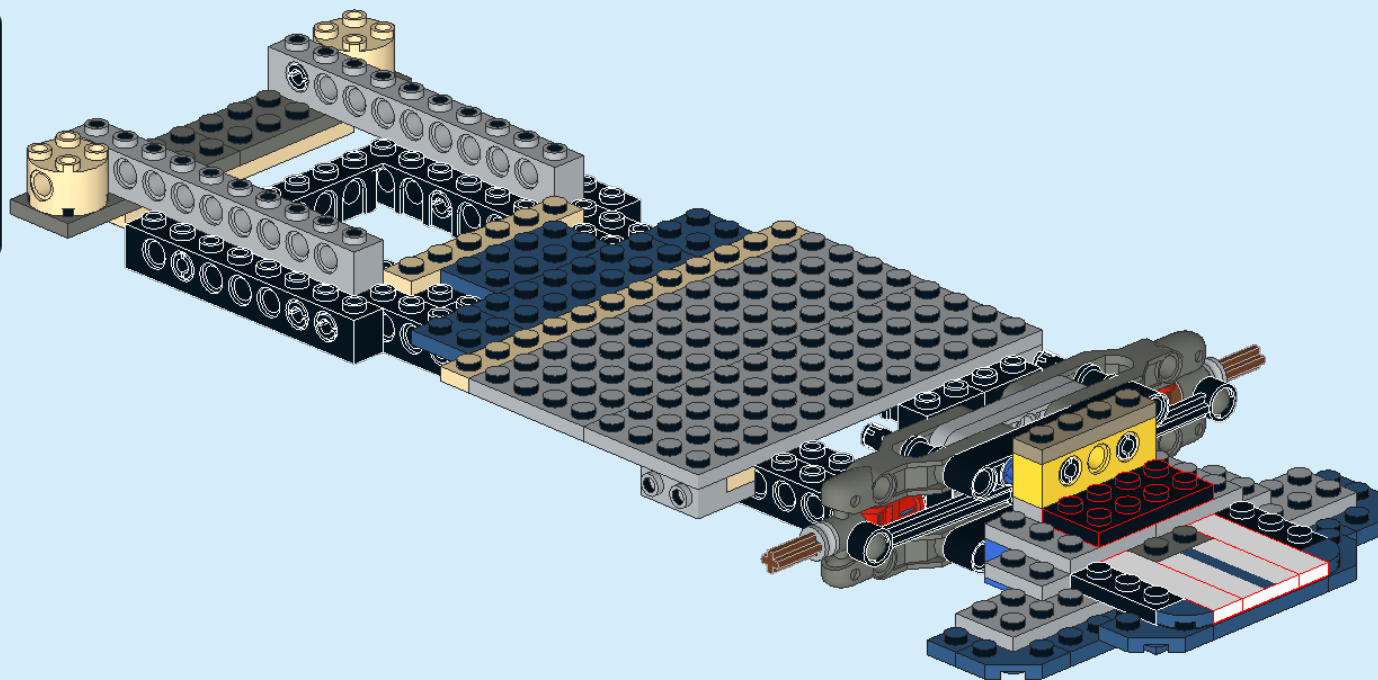
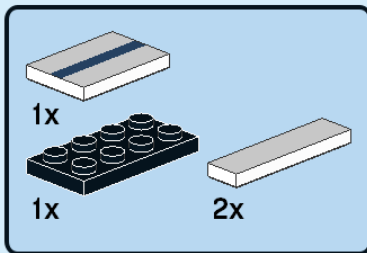

15

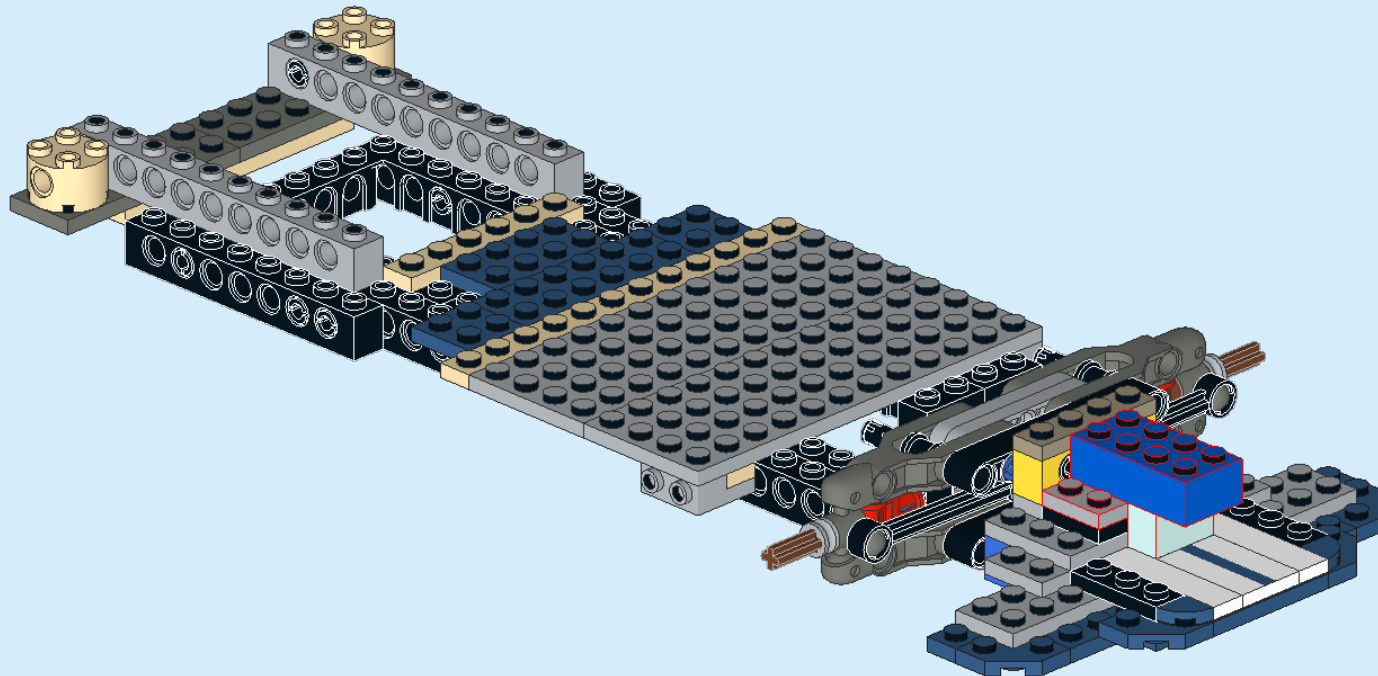
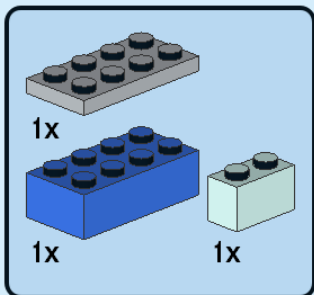

16

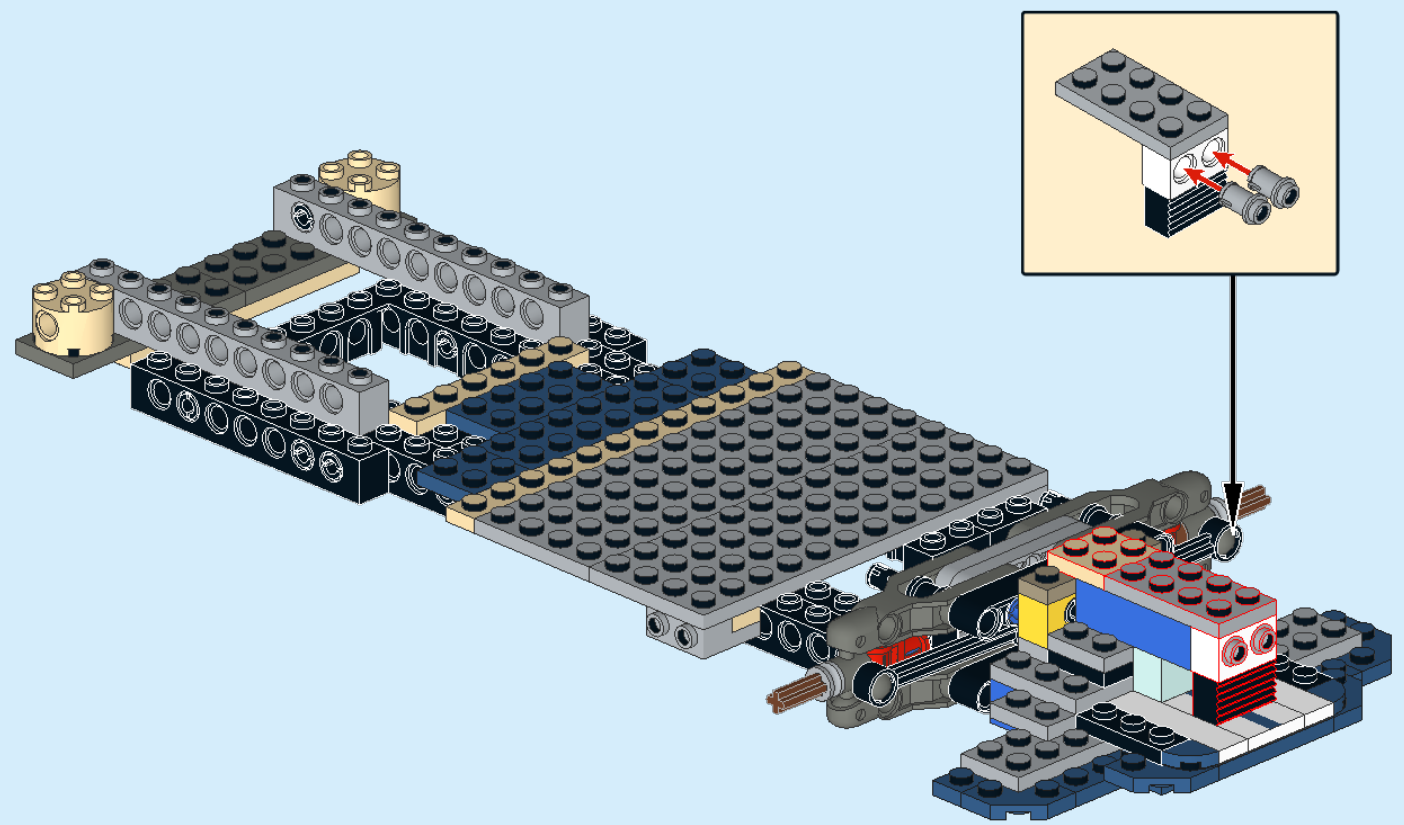
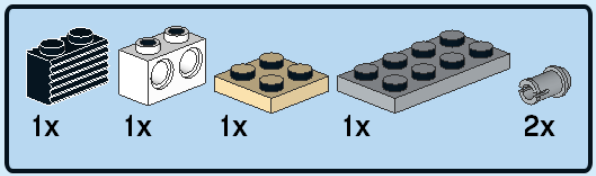

18

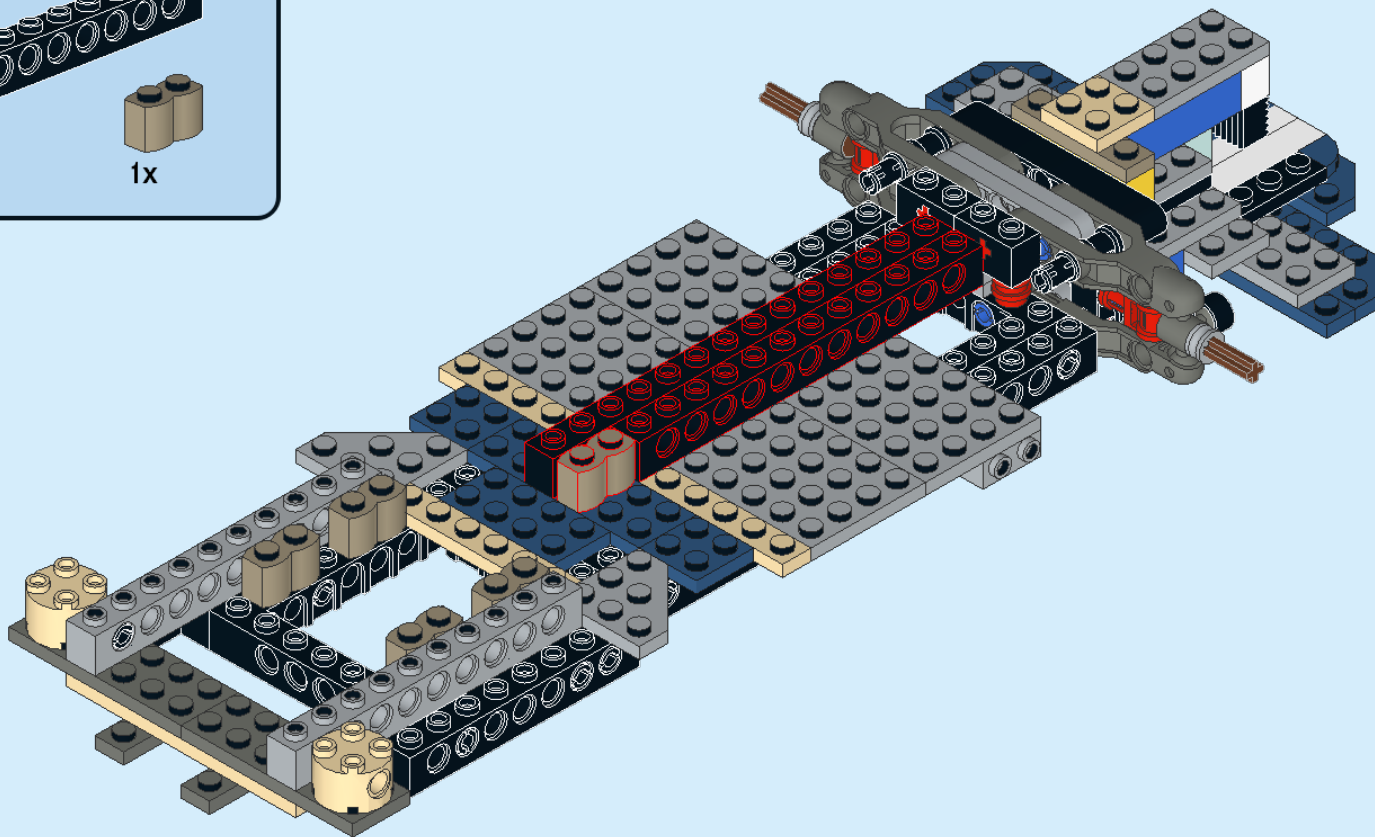
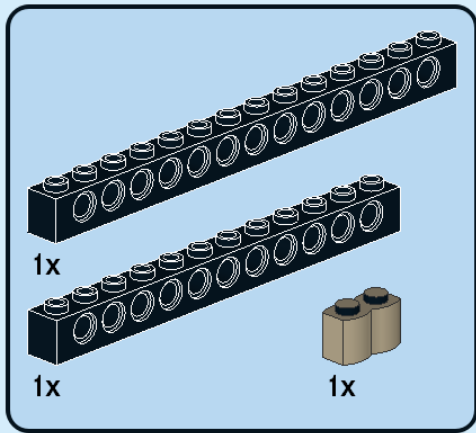

19

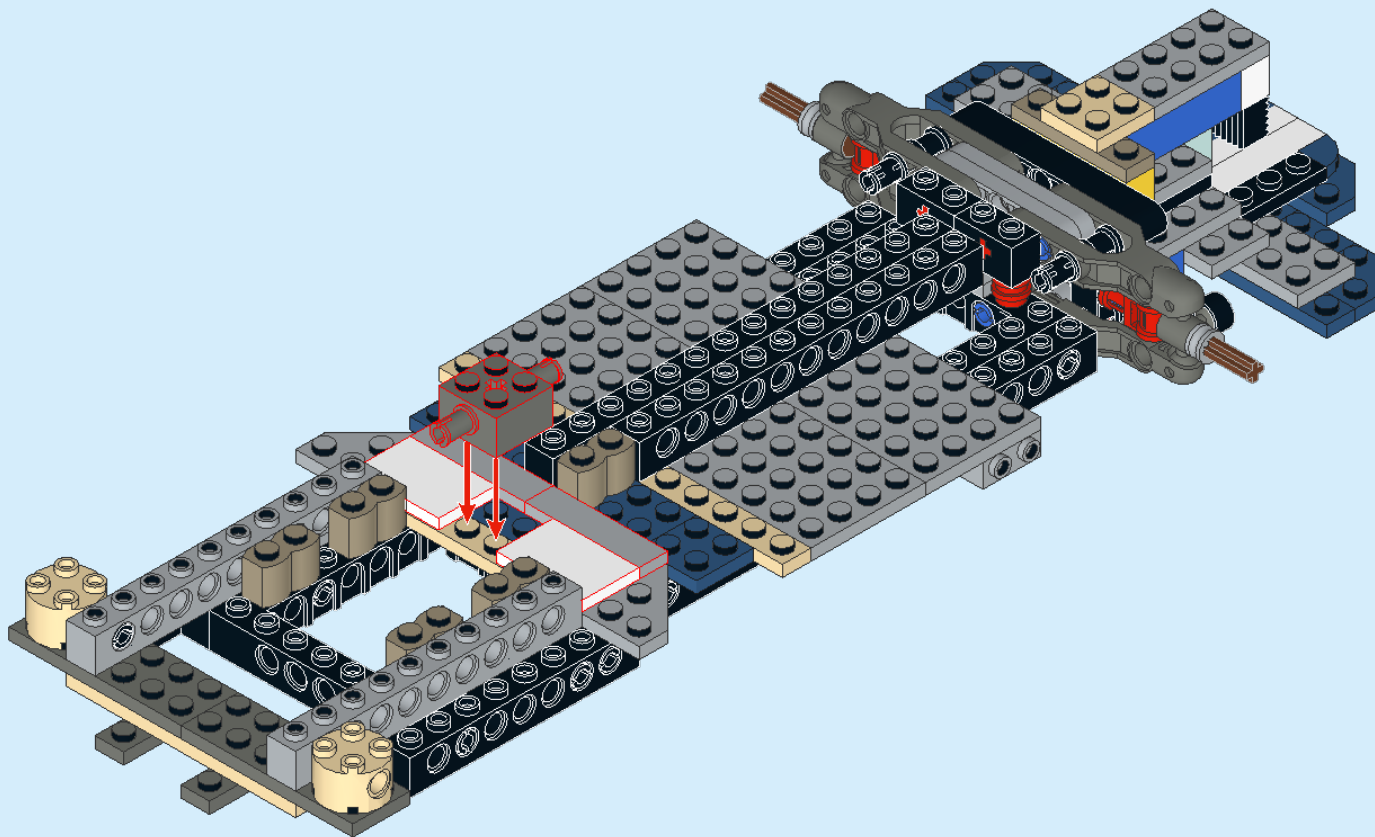
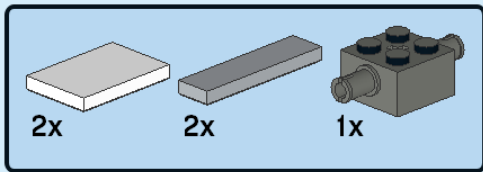

20

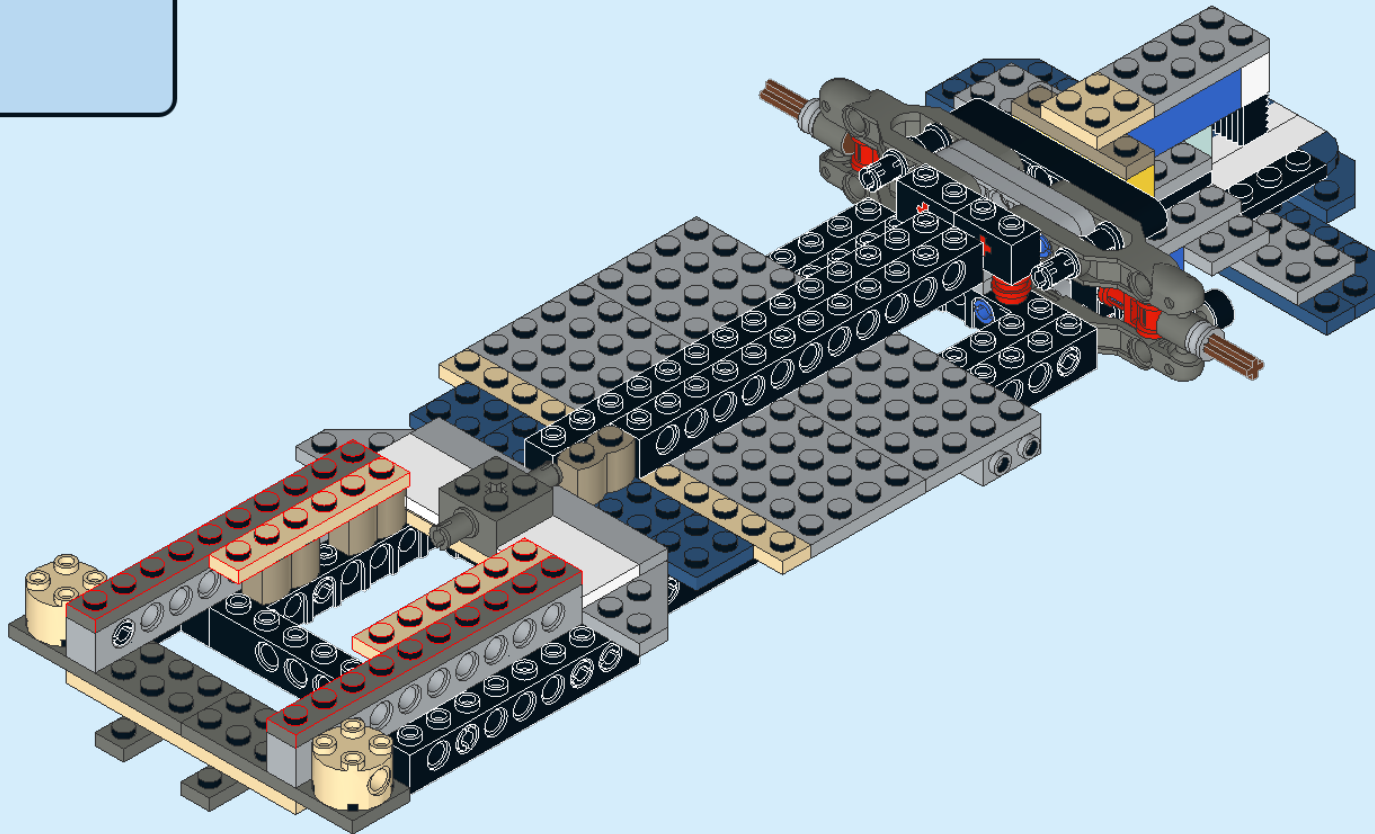
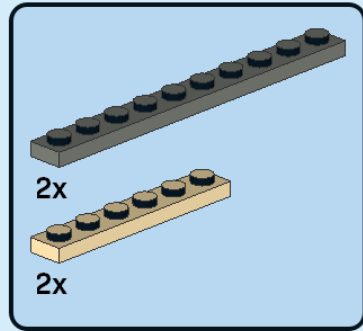

21

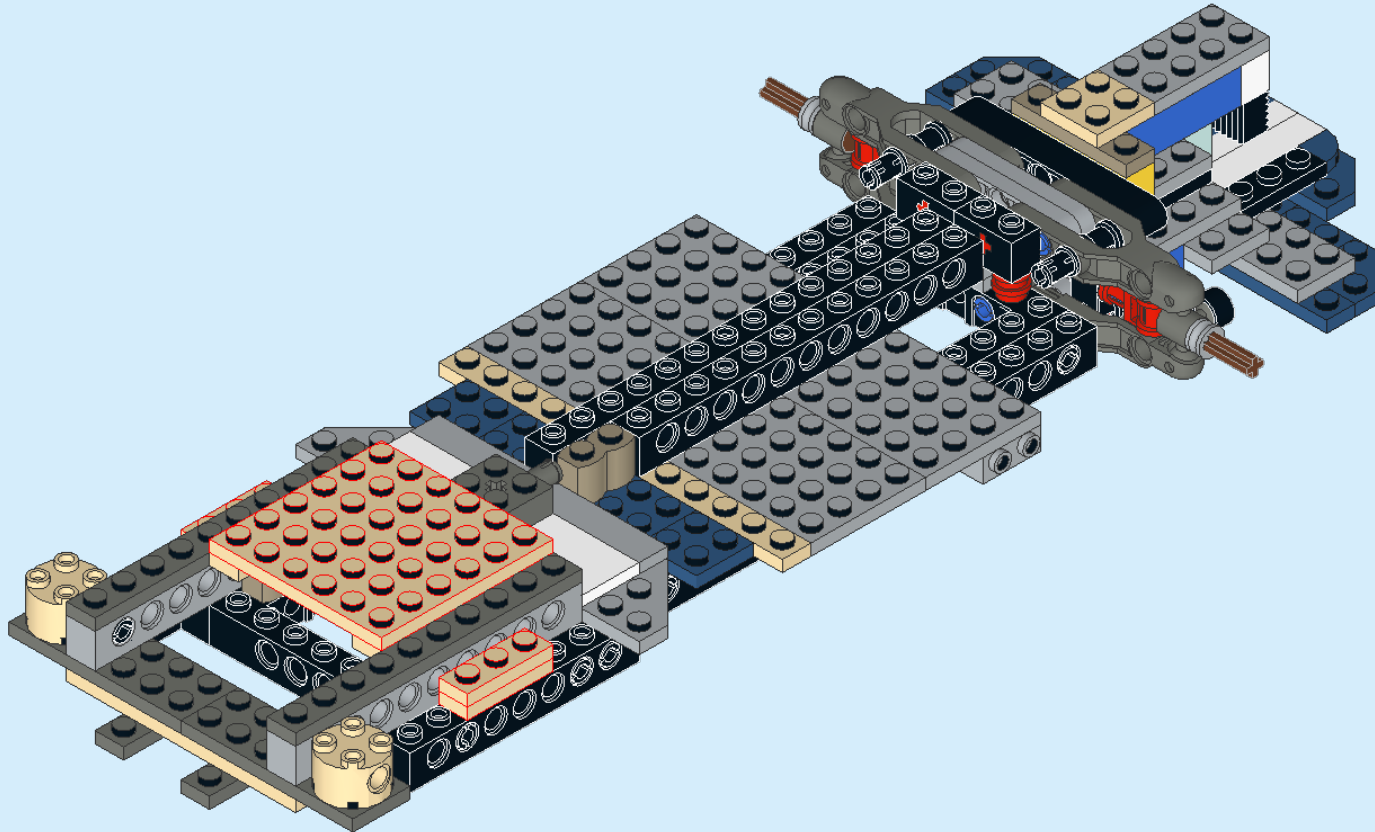
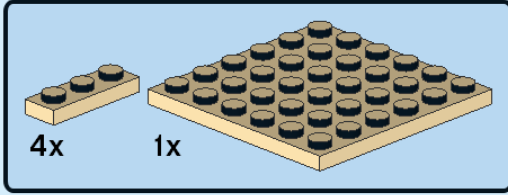

22

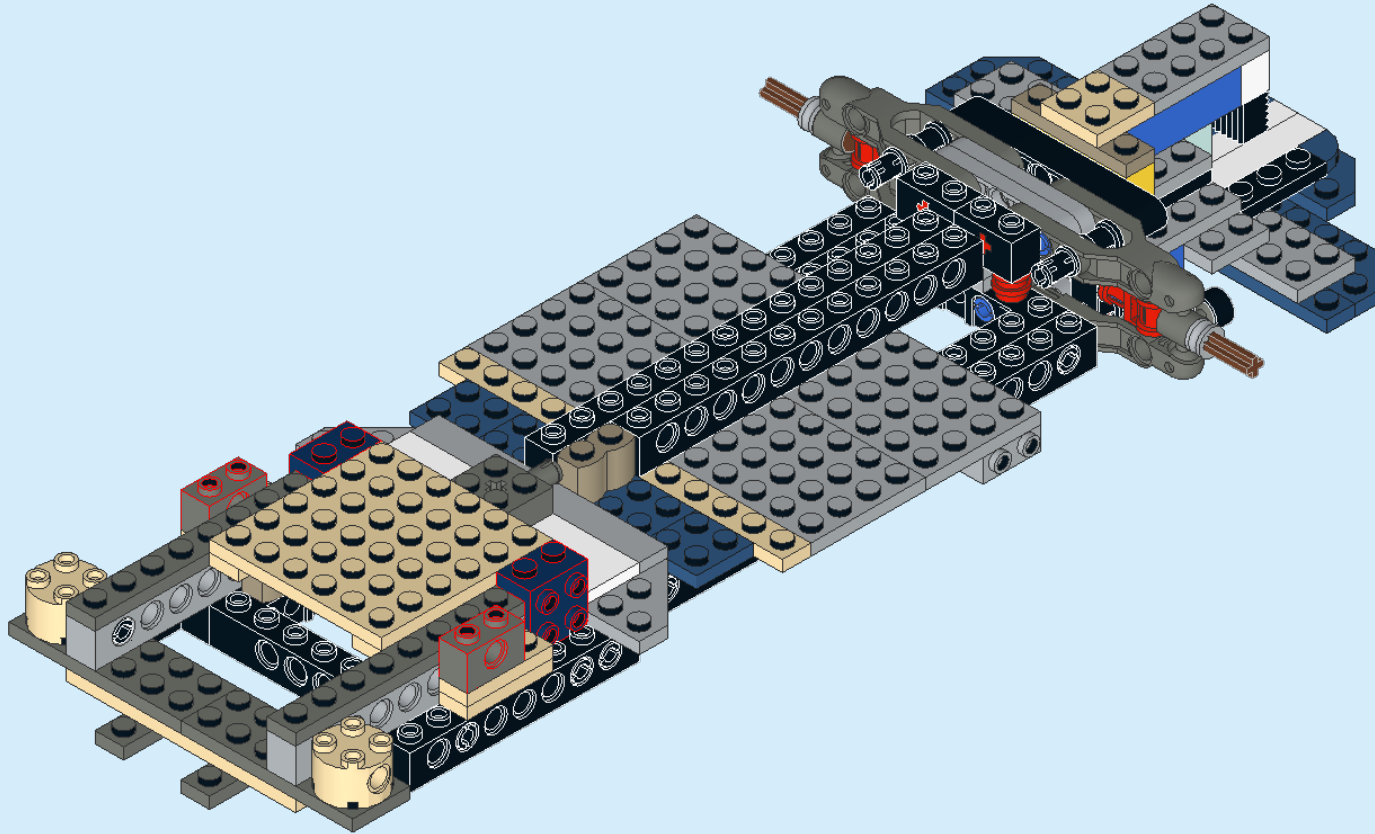
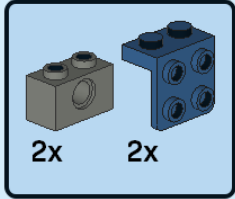

24

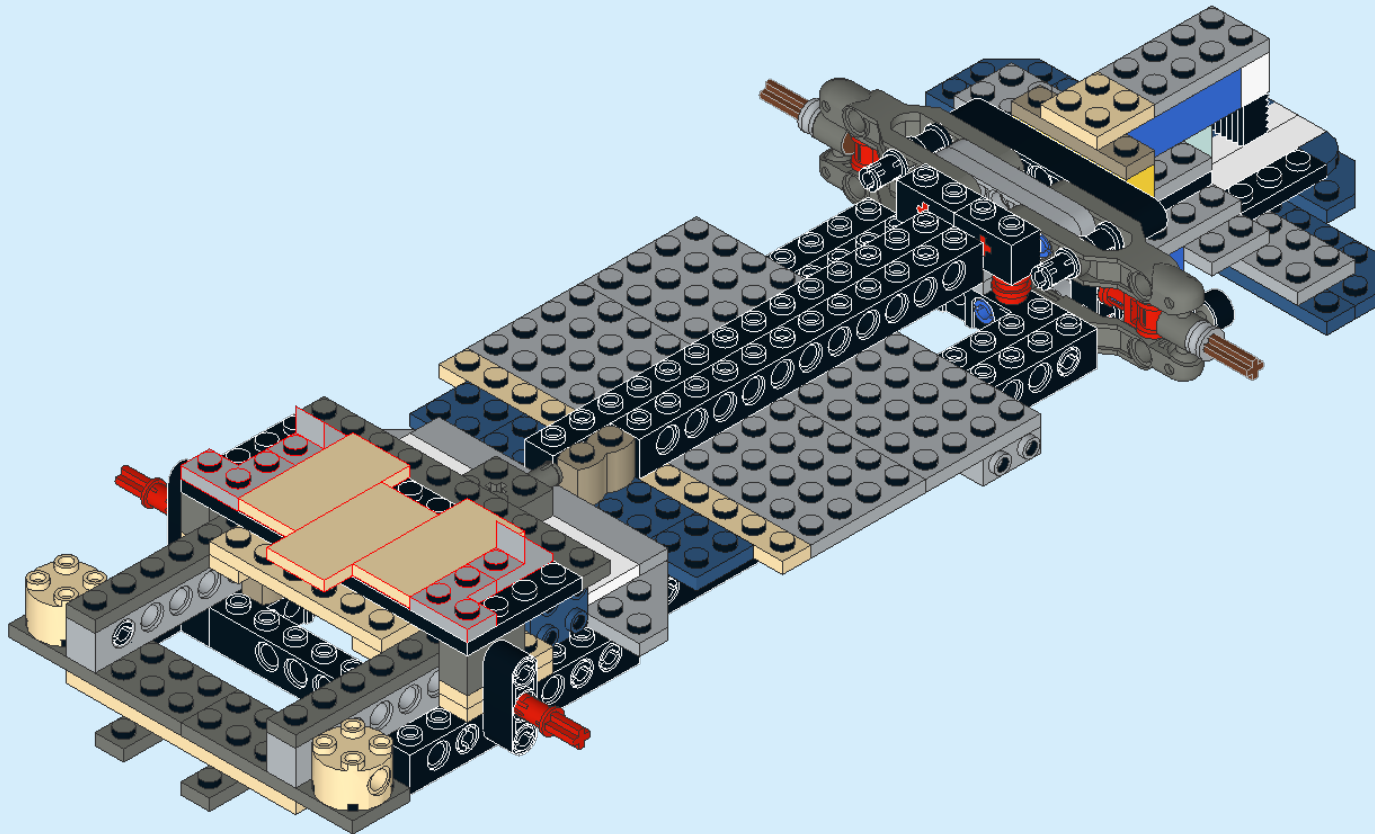
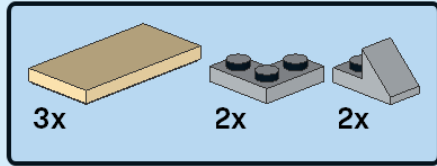

25

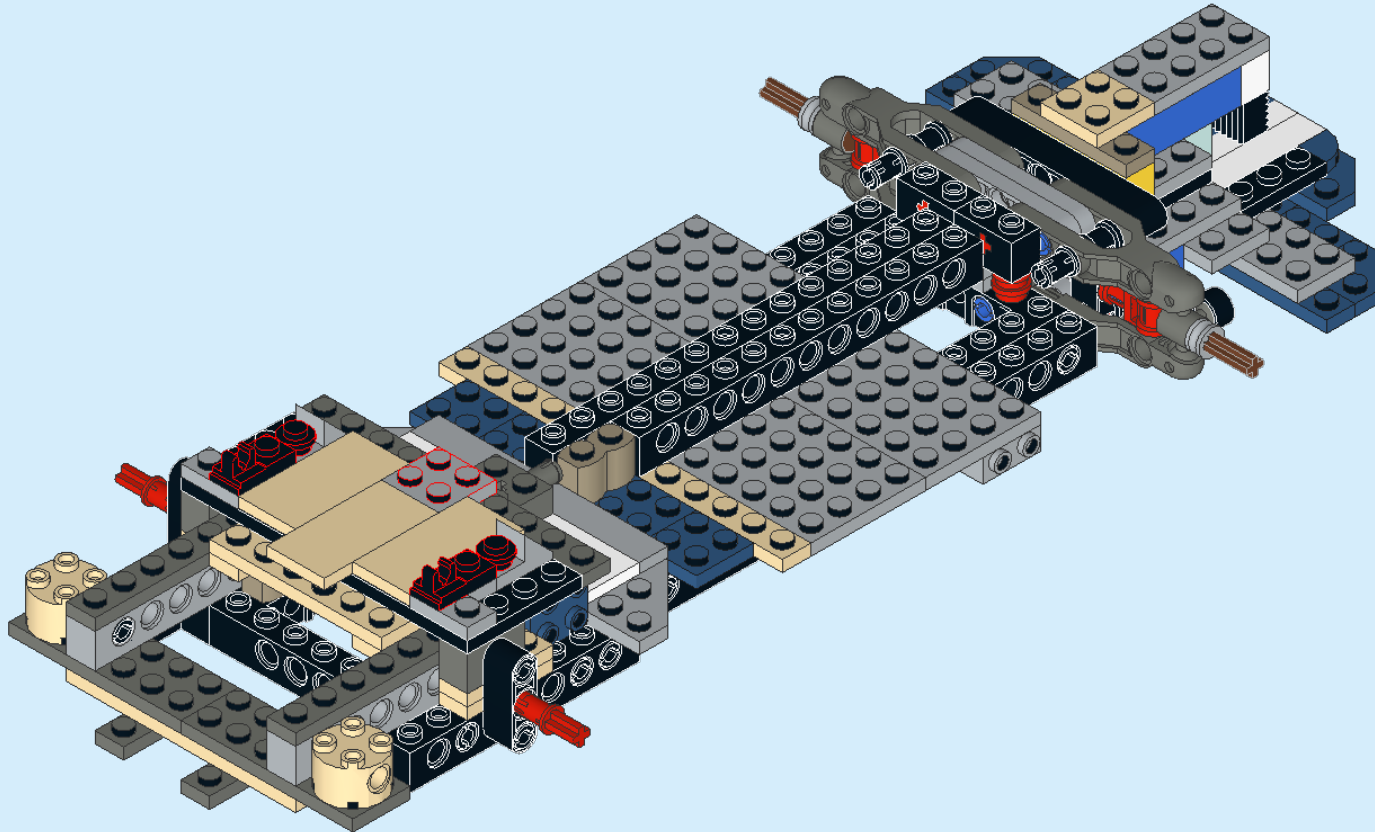
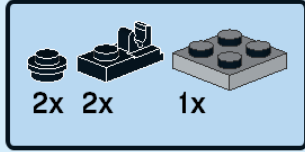

26

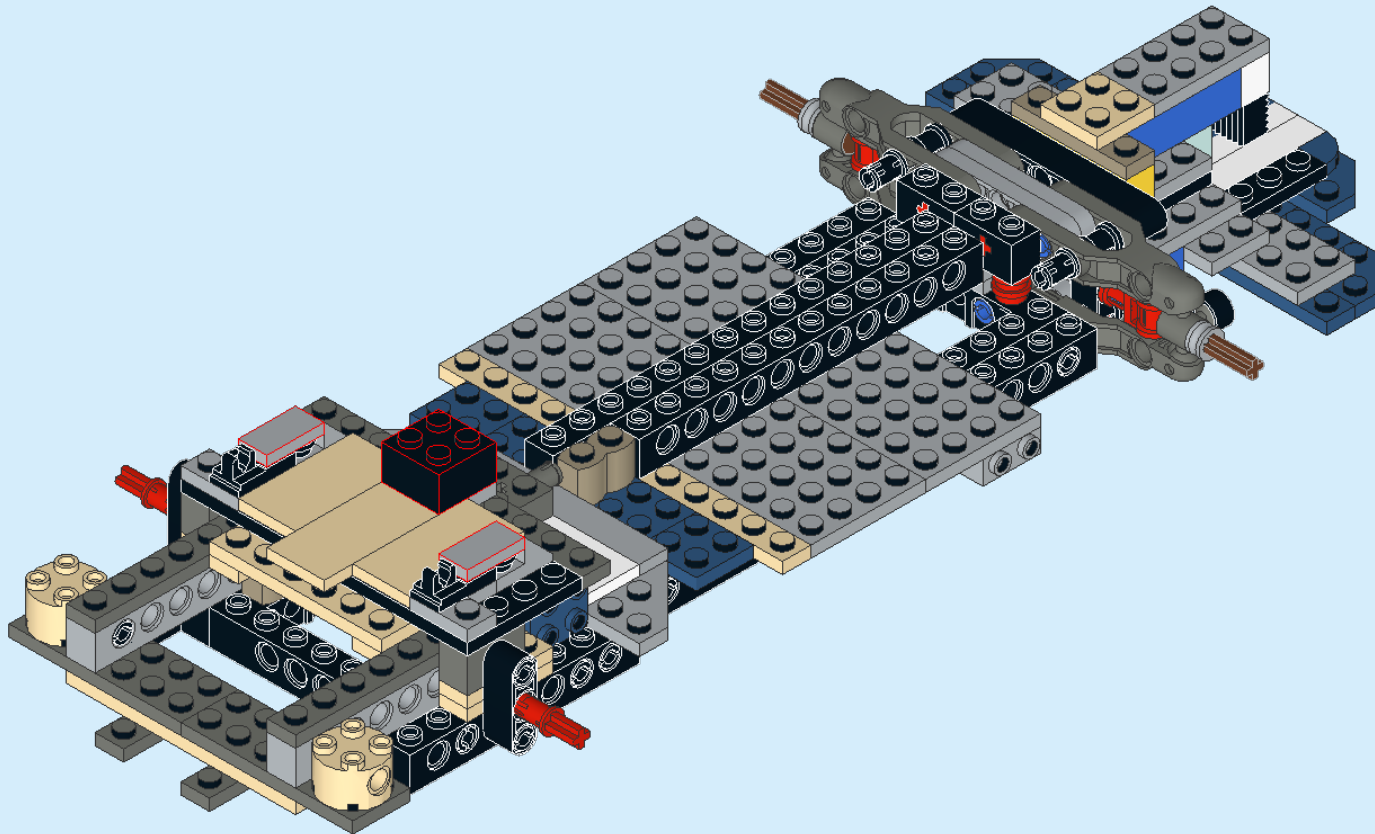
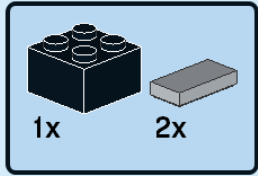

27

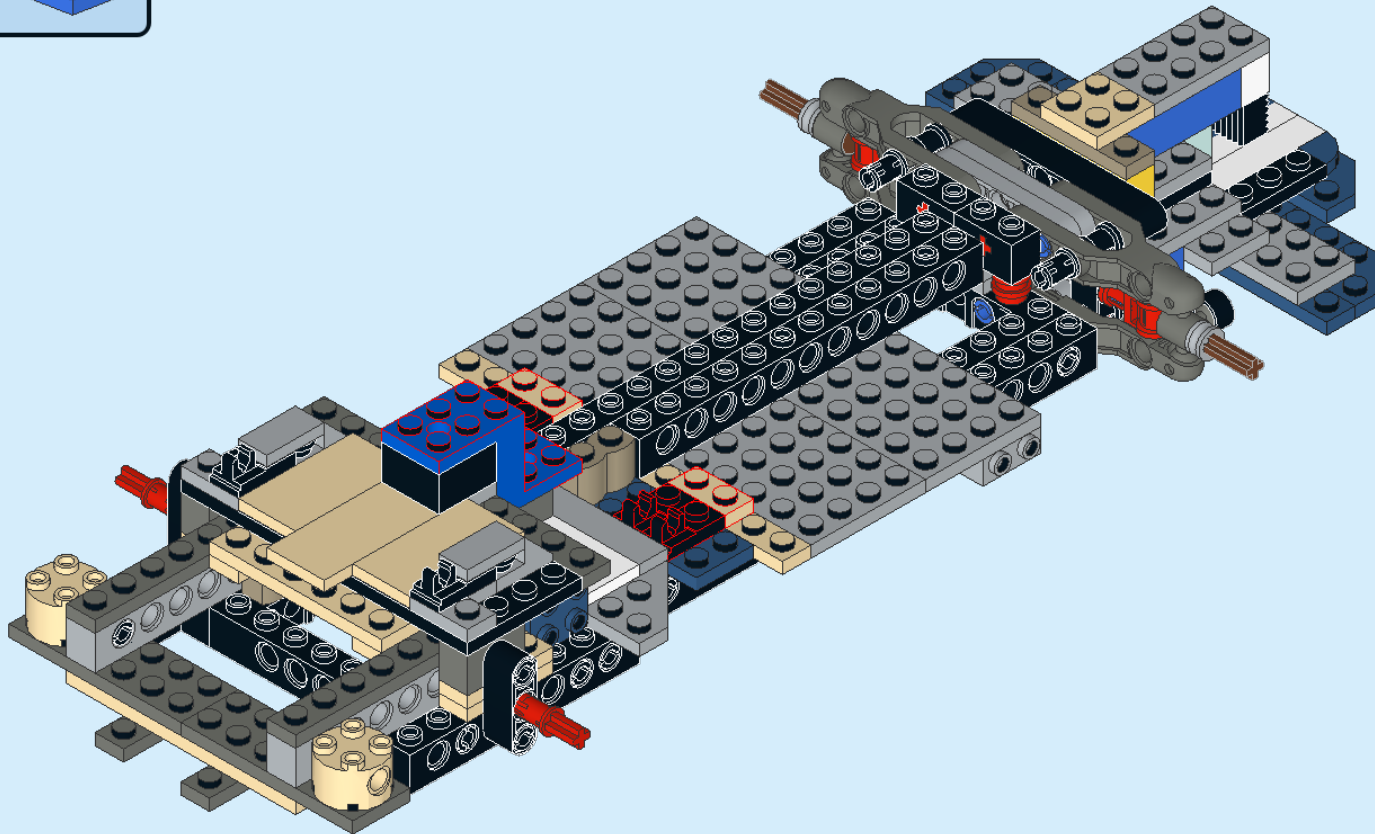
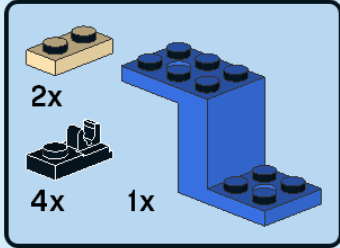

28

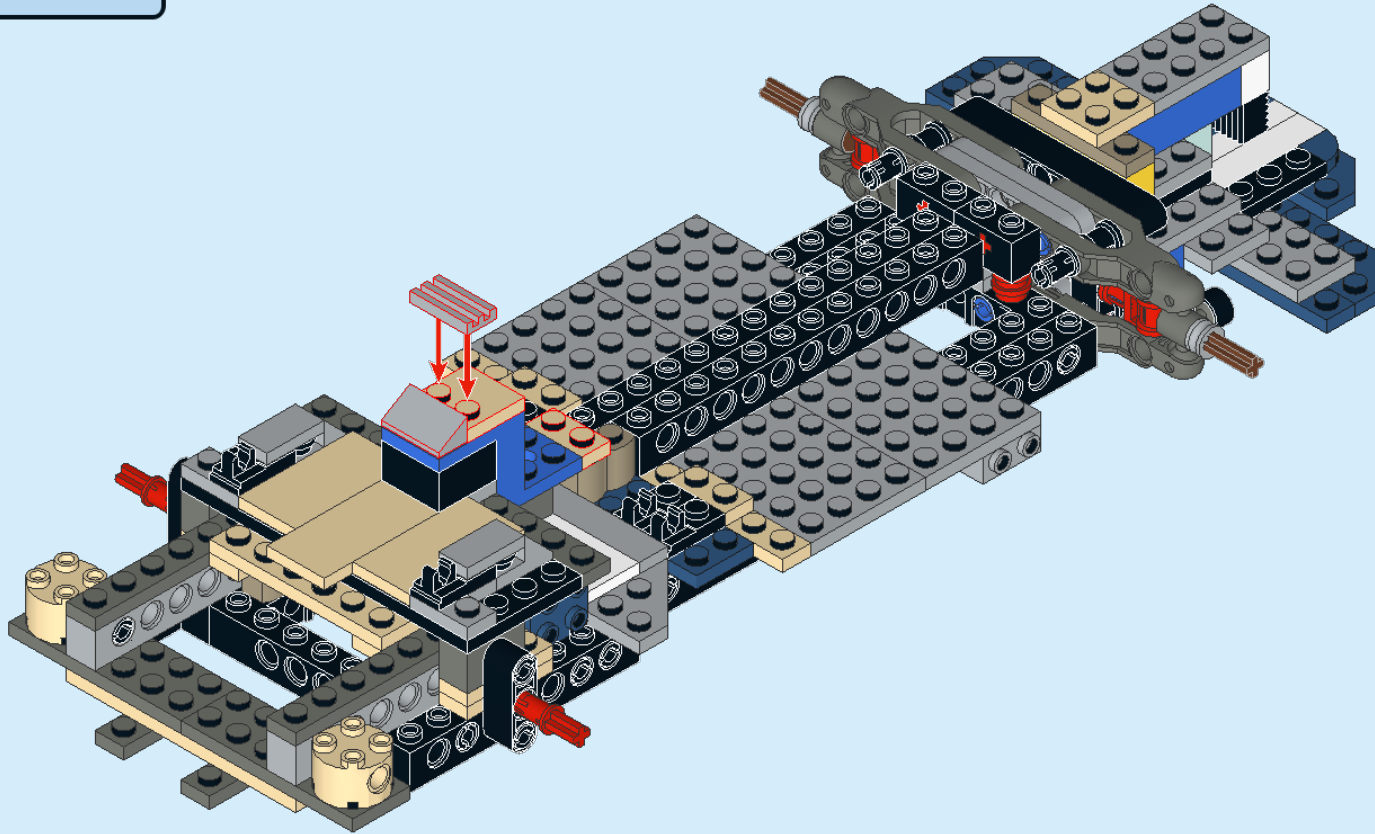
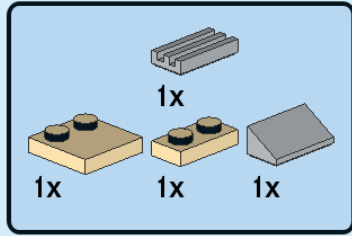

29

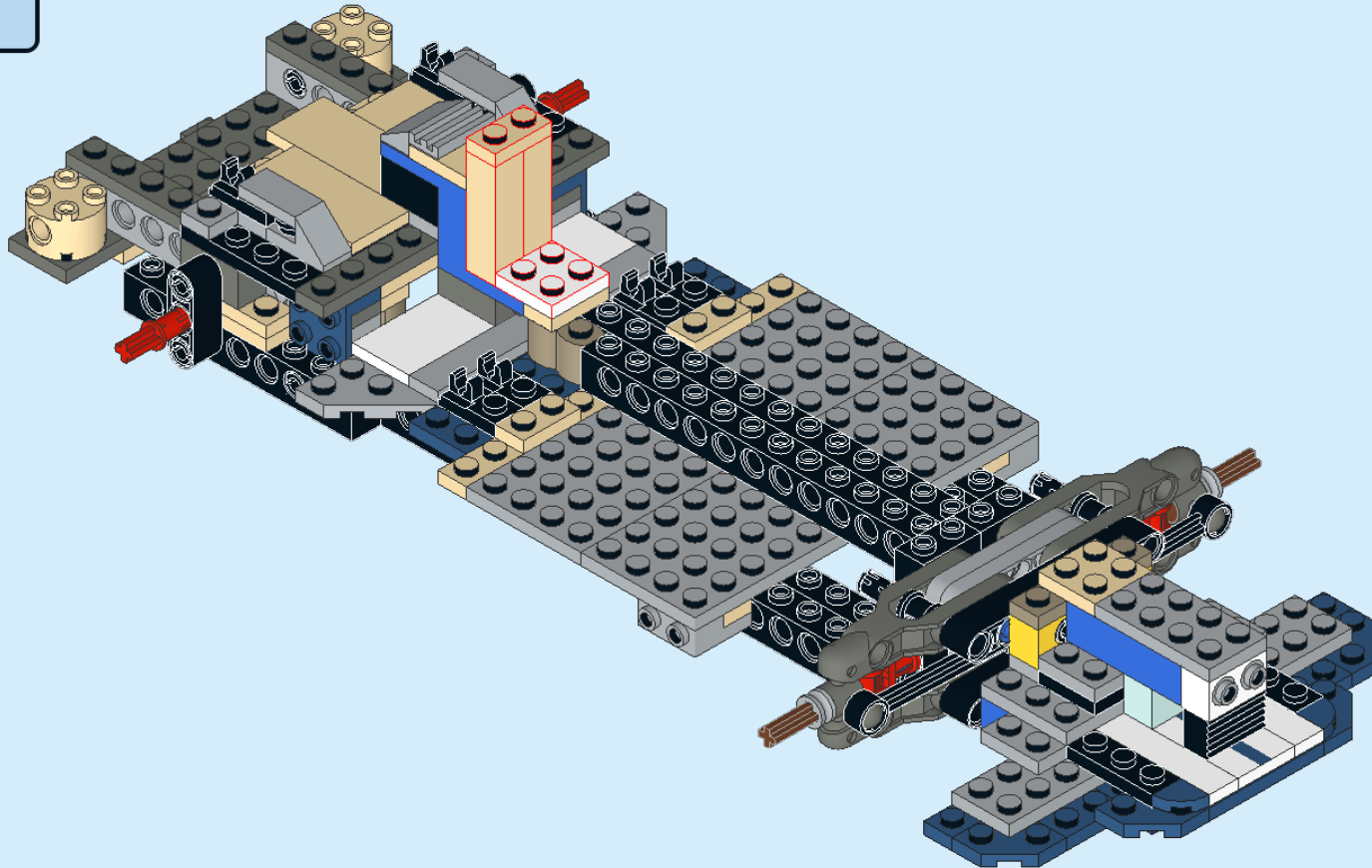
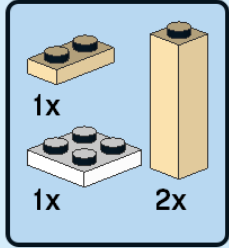

30

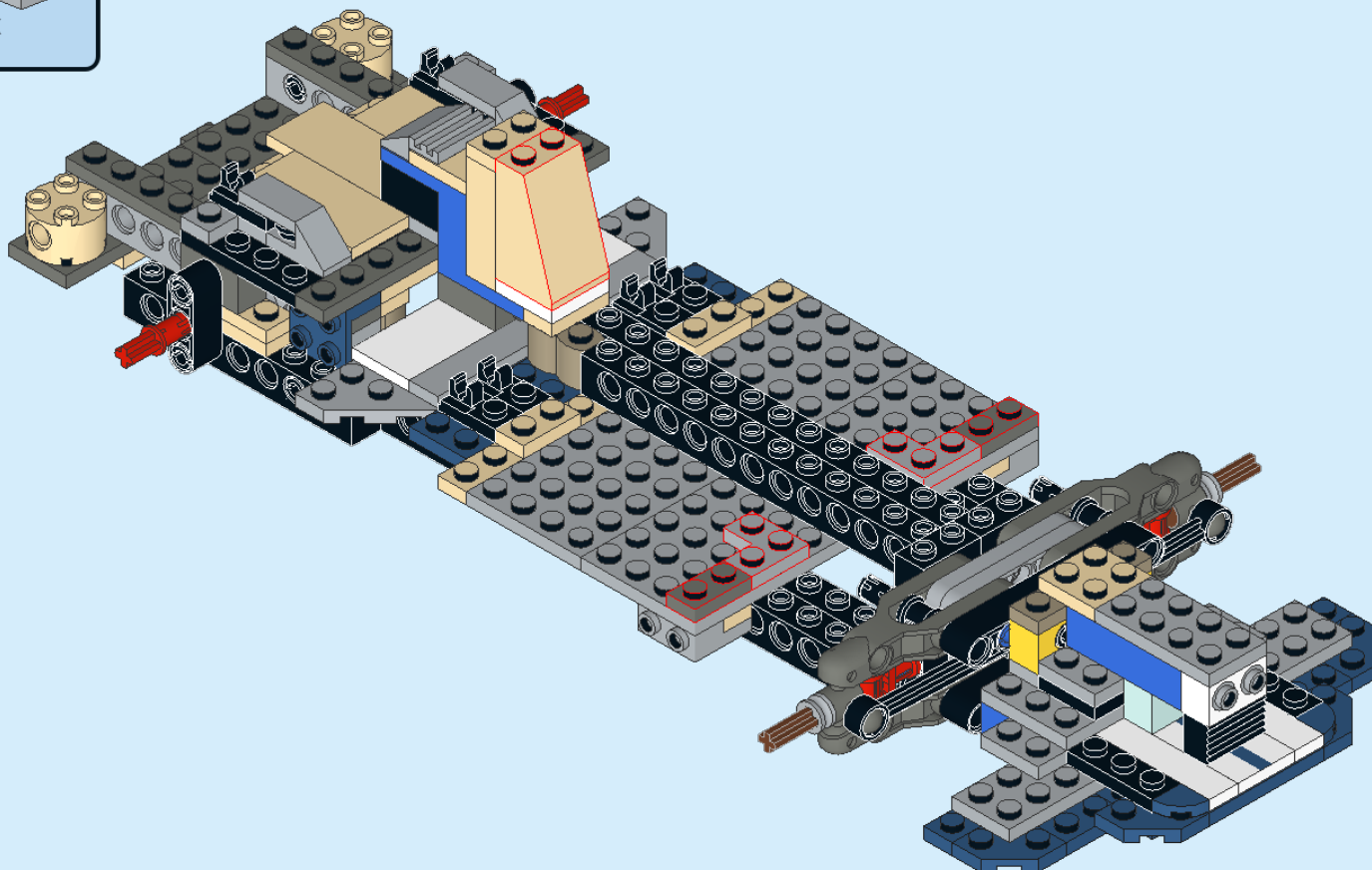
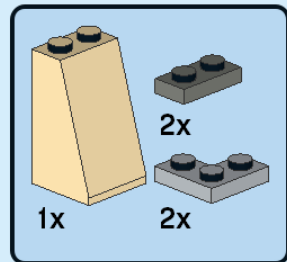

31

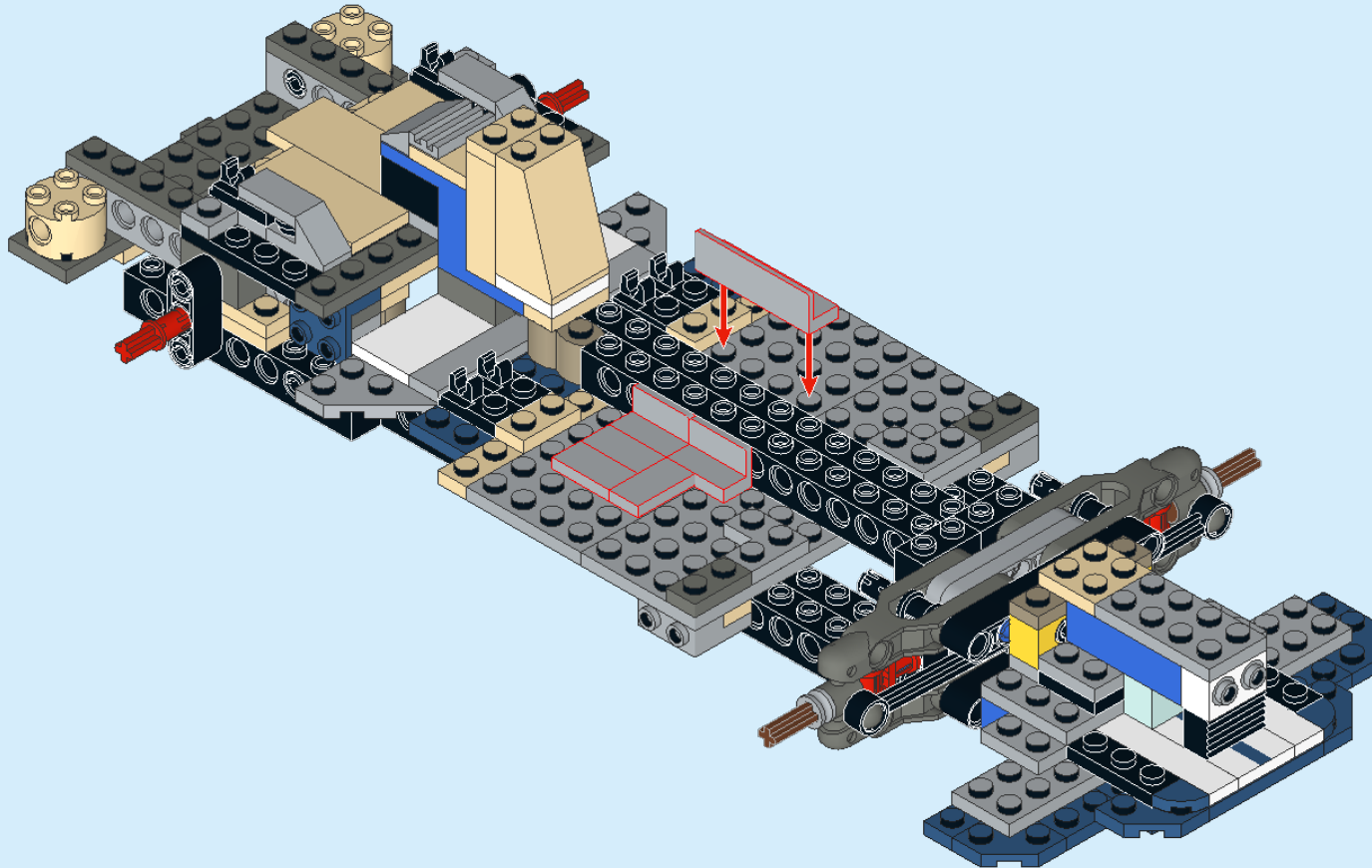
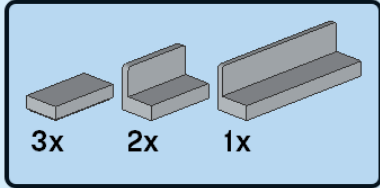

32

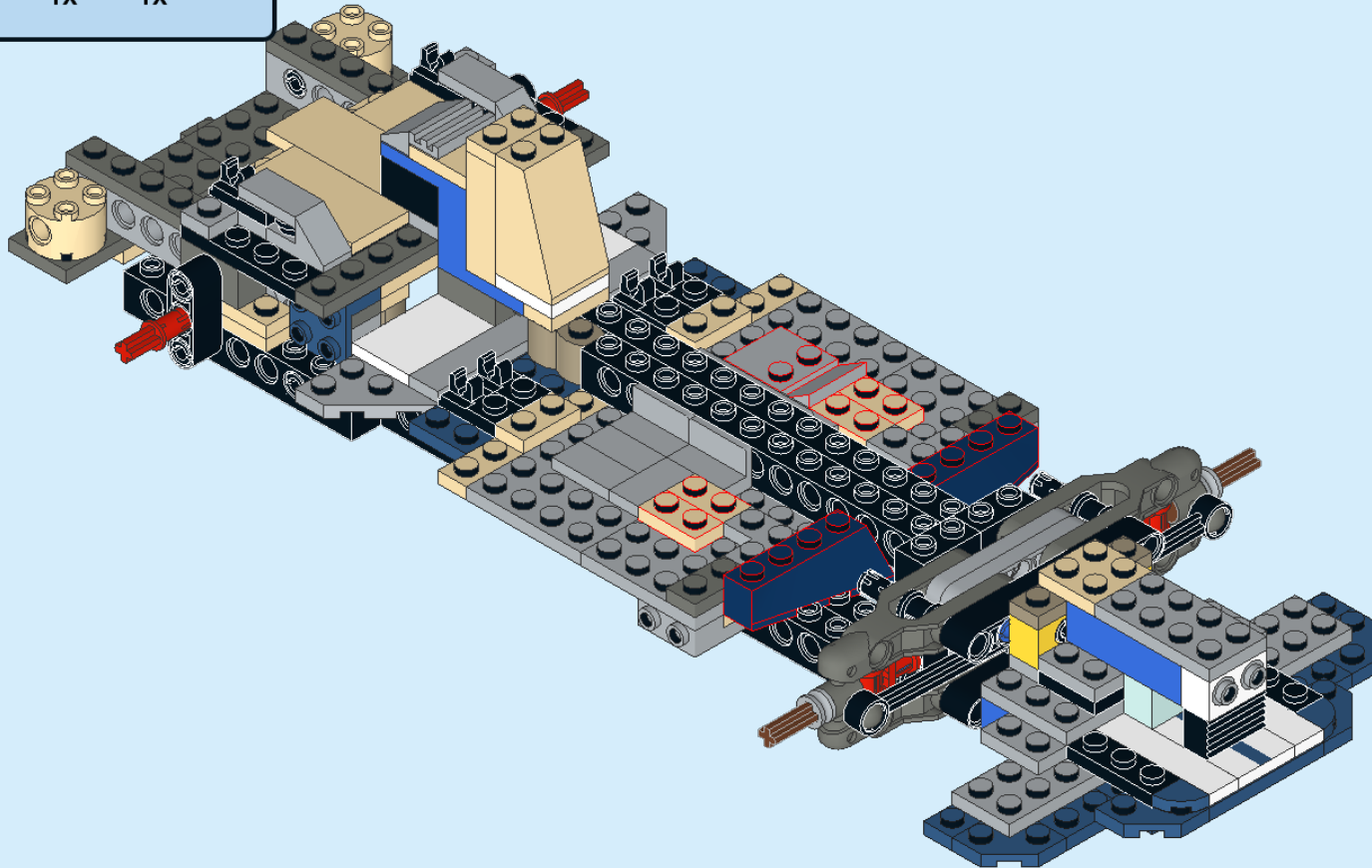
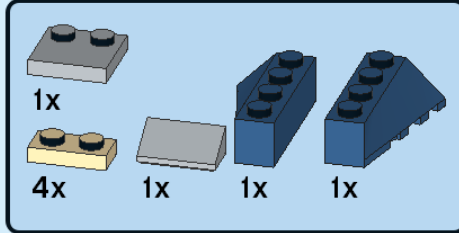

33

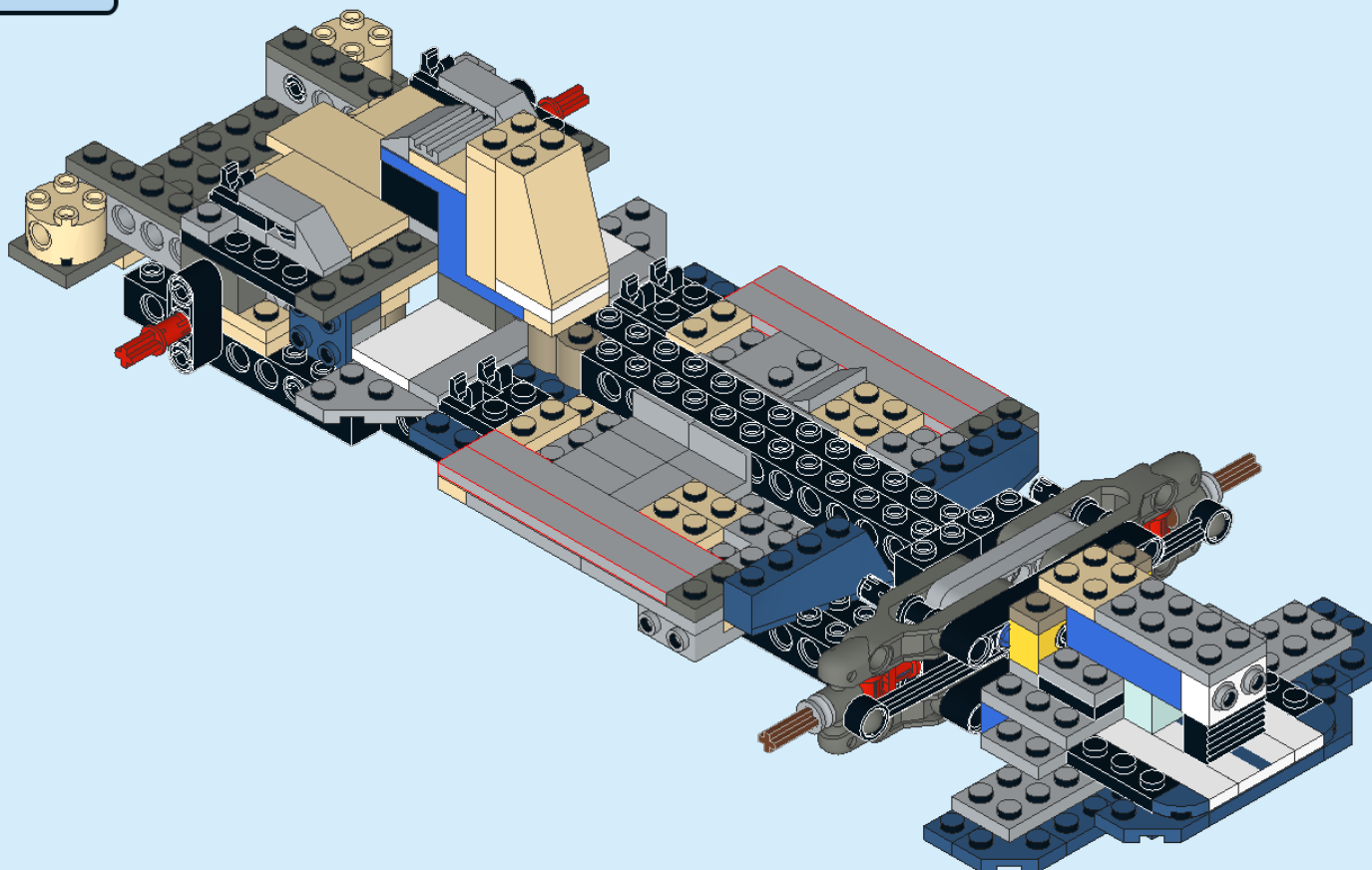
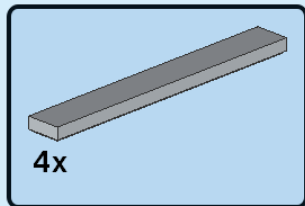

34

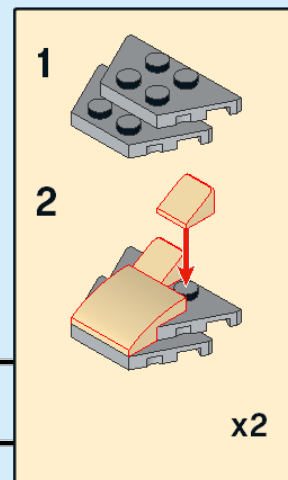
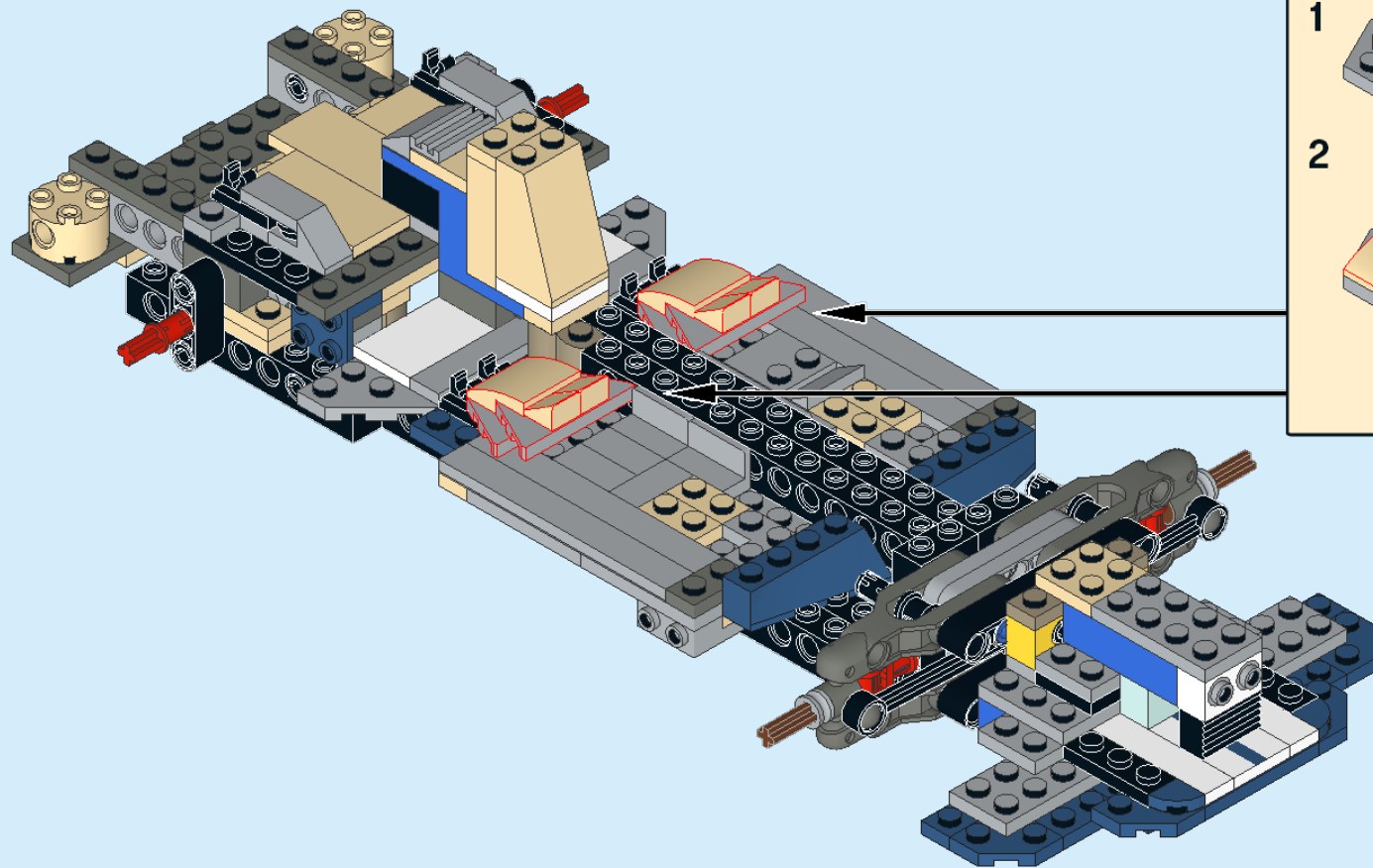
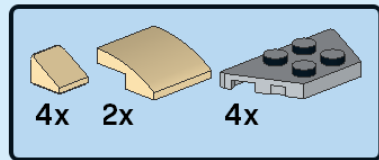

35

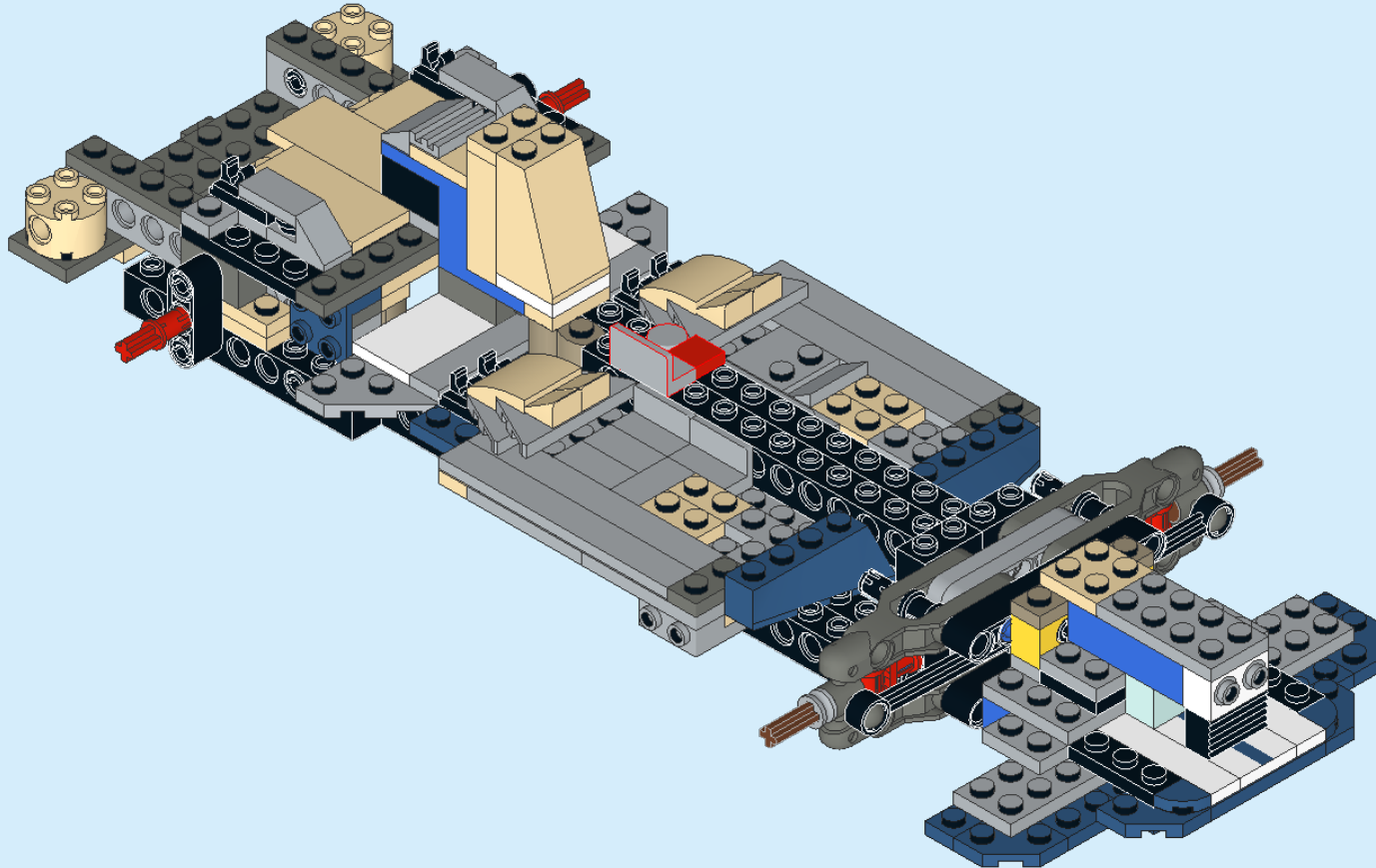
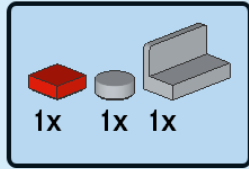

36

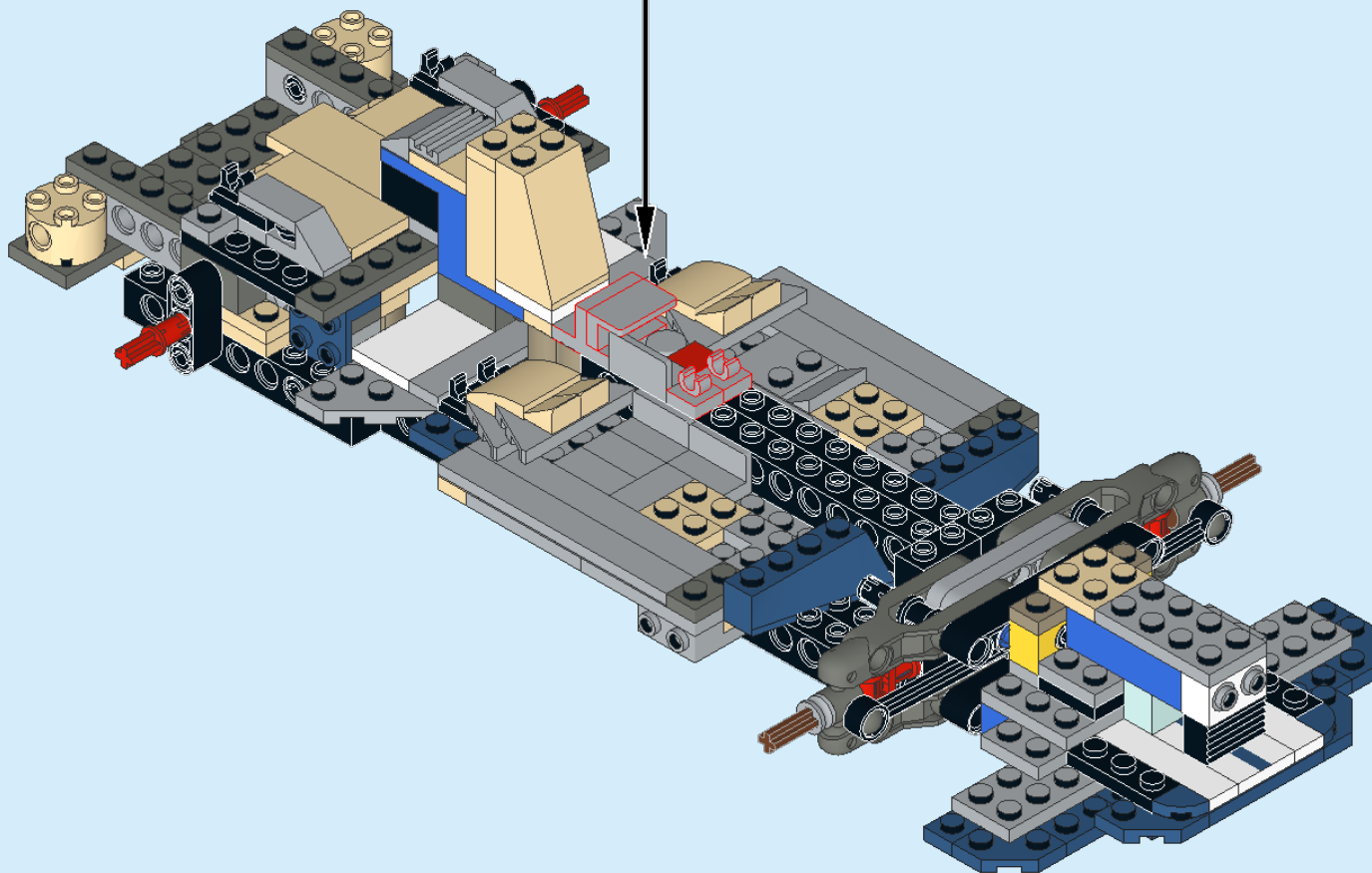
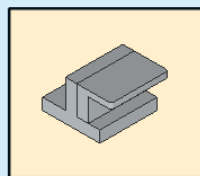
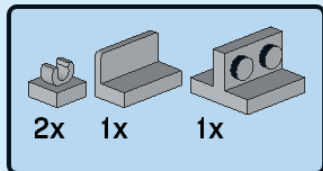

37

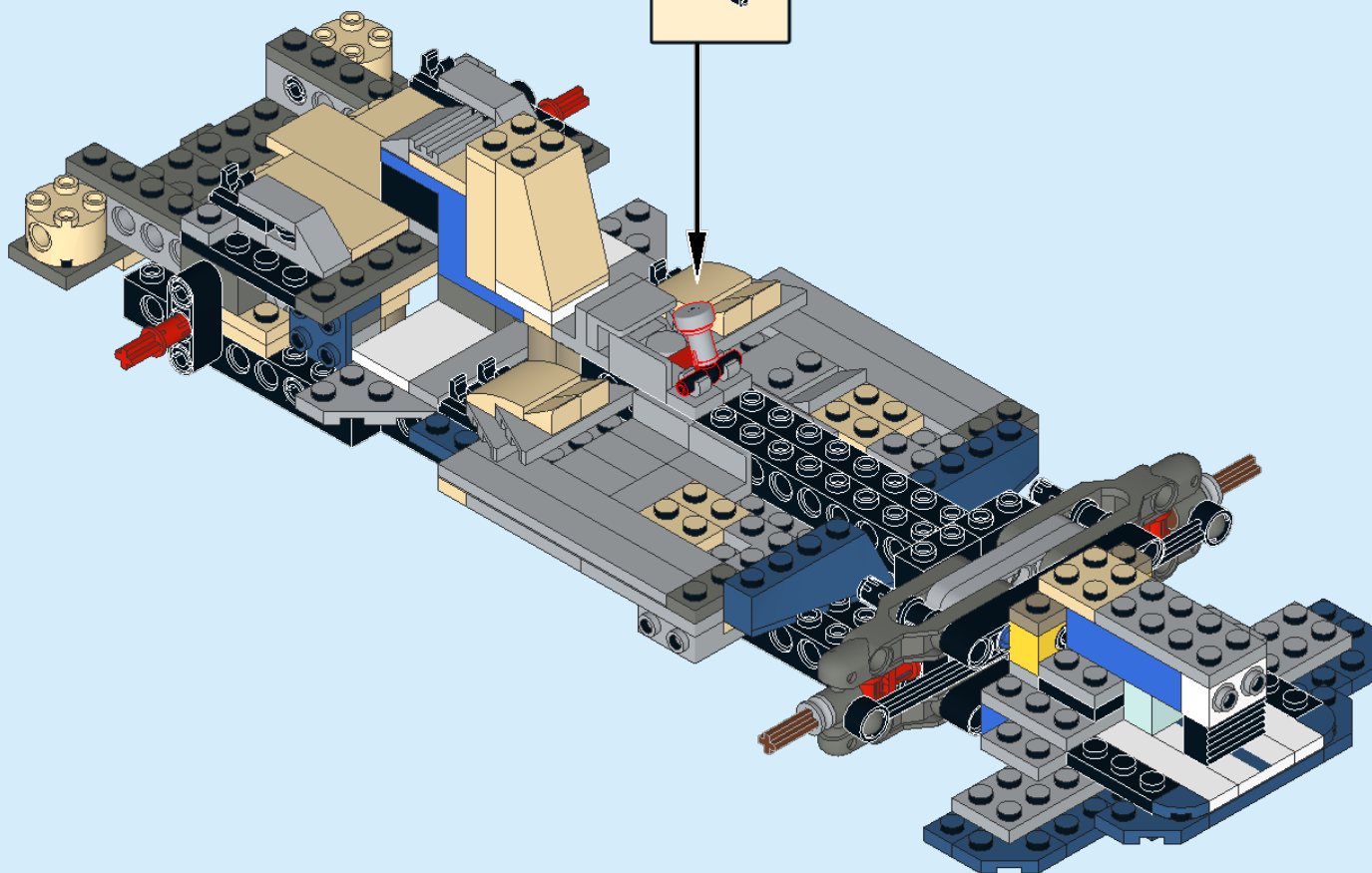
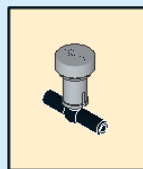
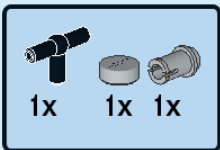

38

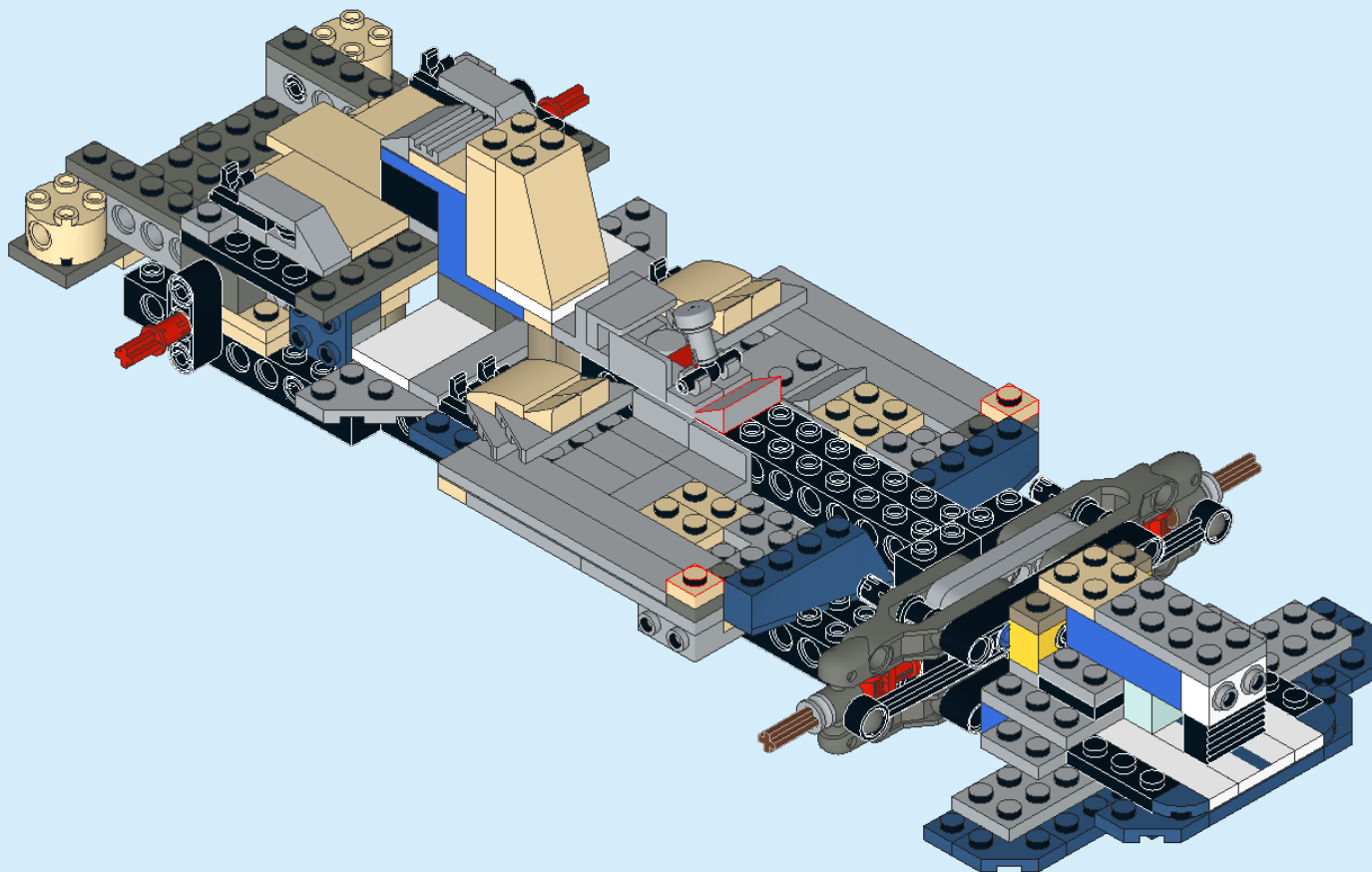
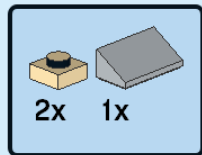

39

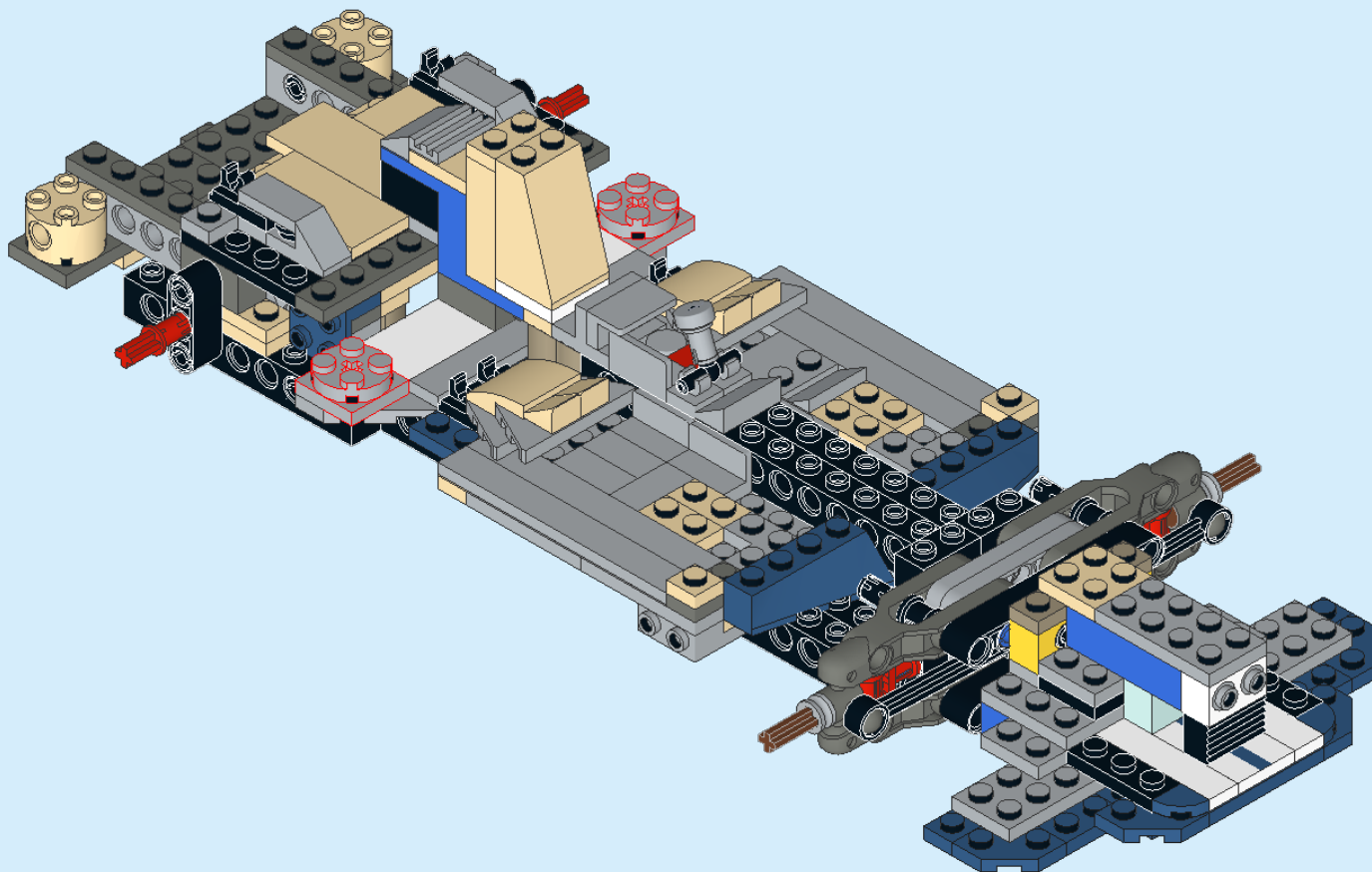
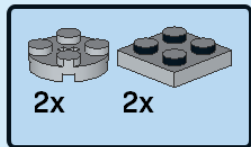

40

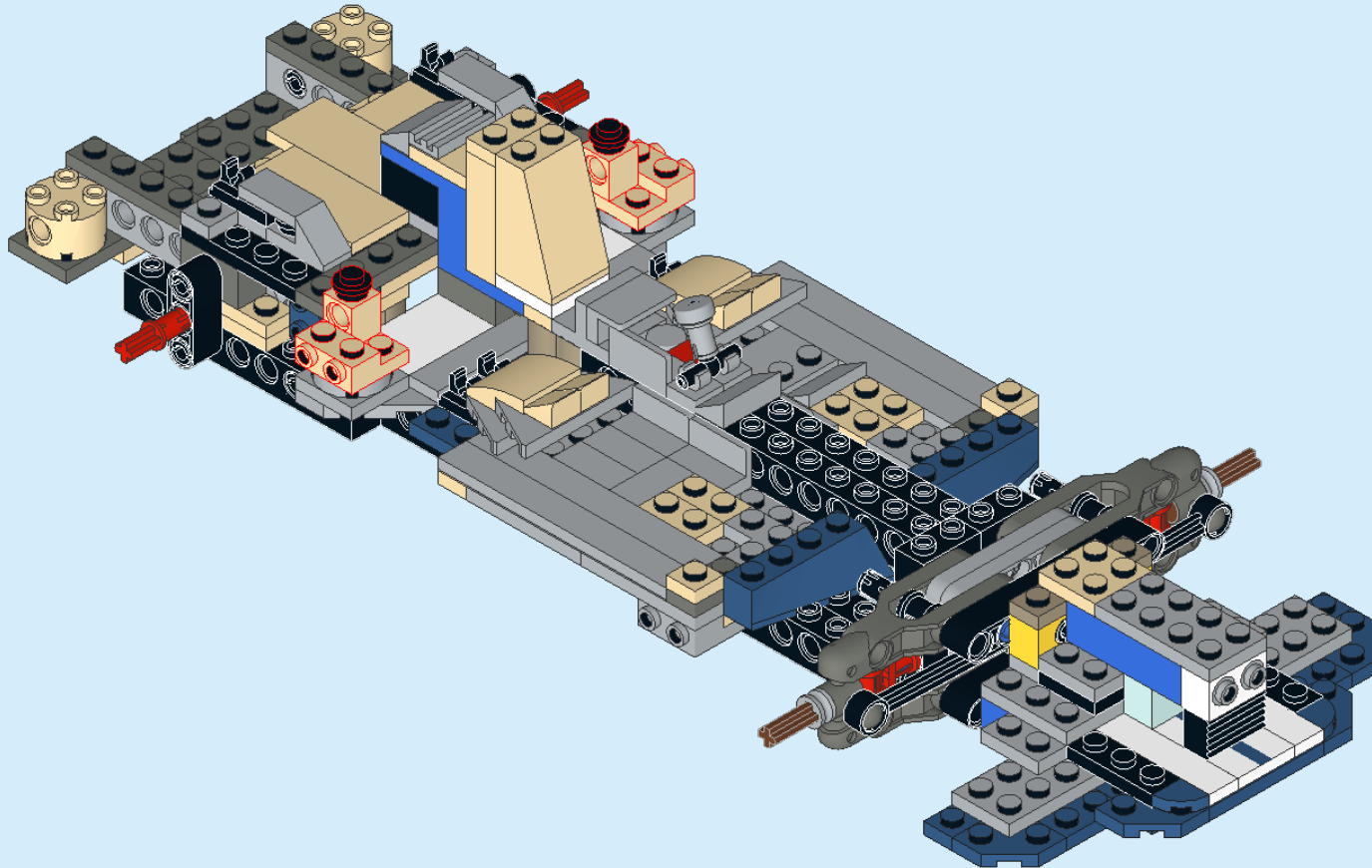
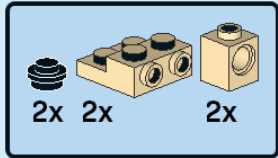

41

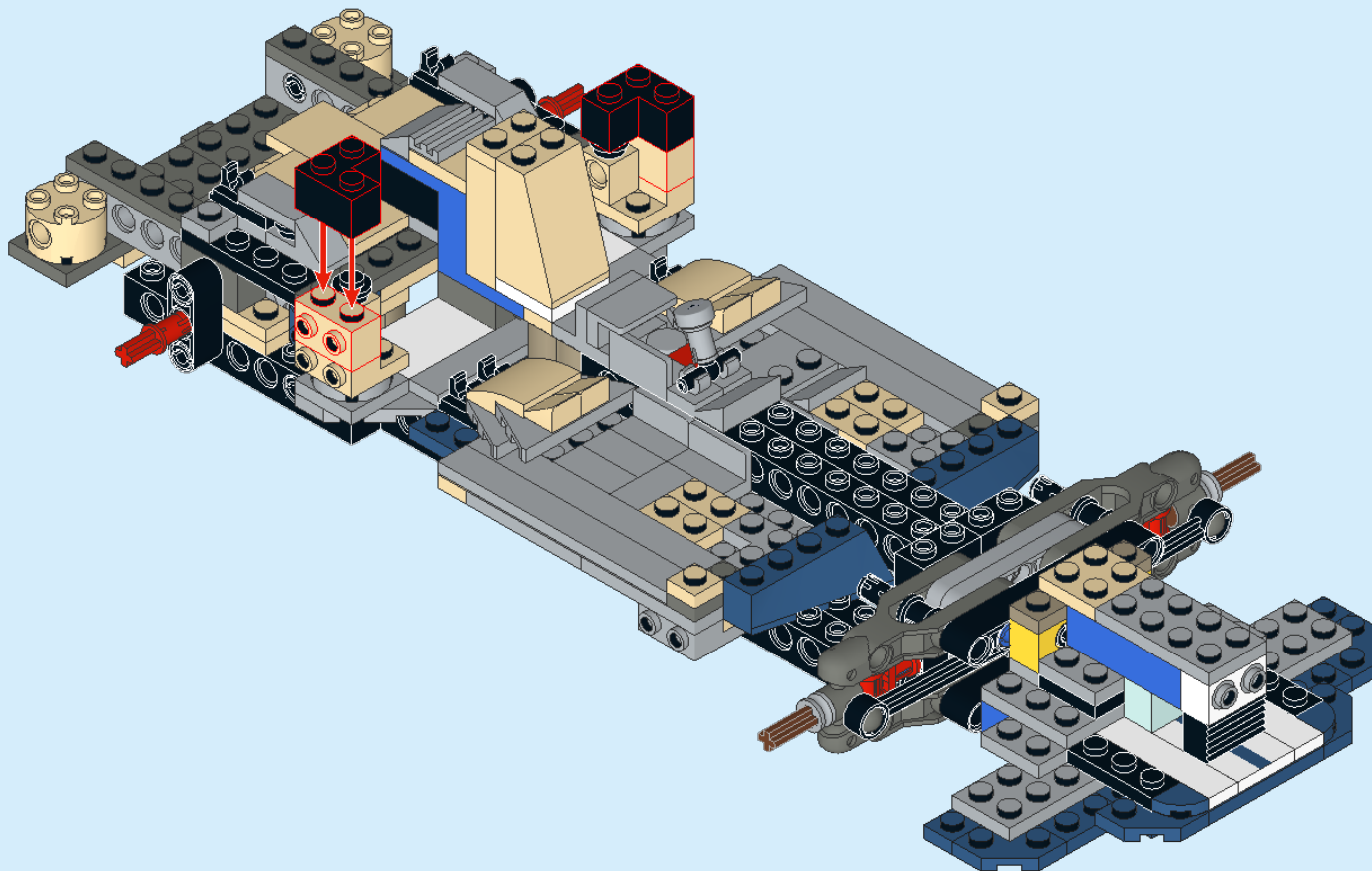
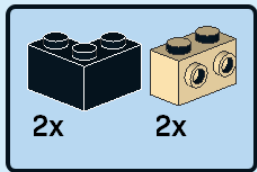

43

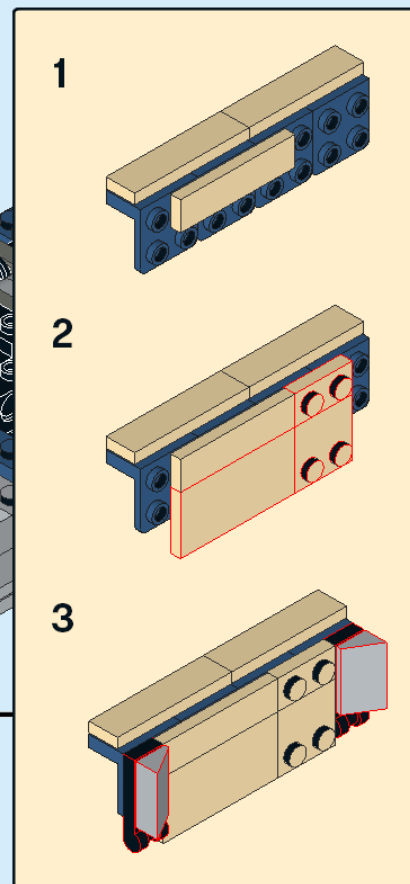
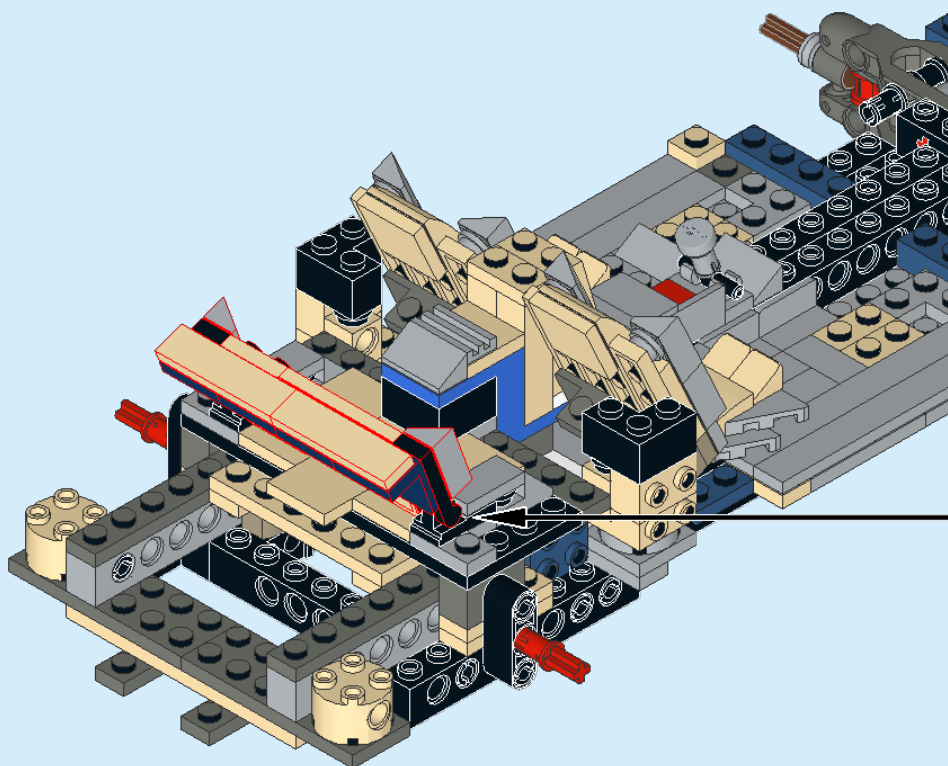
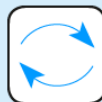
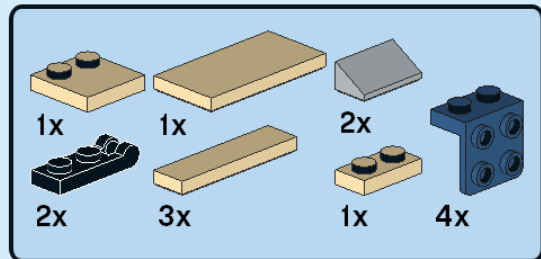

44

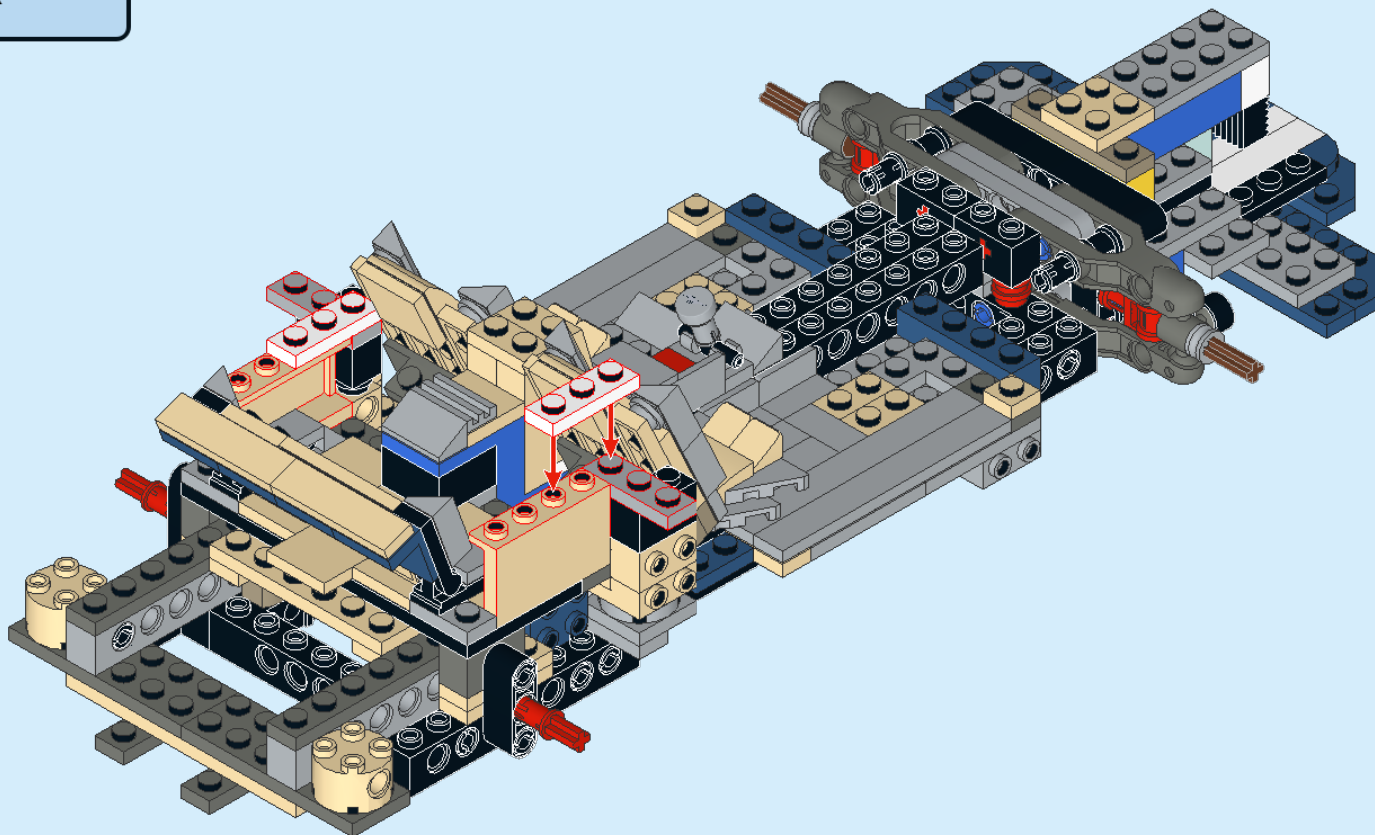
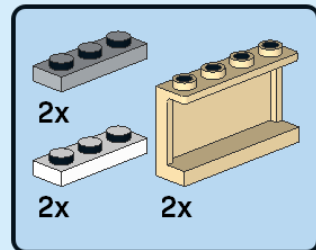

45

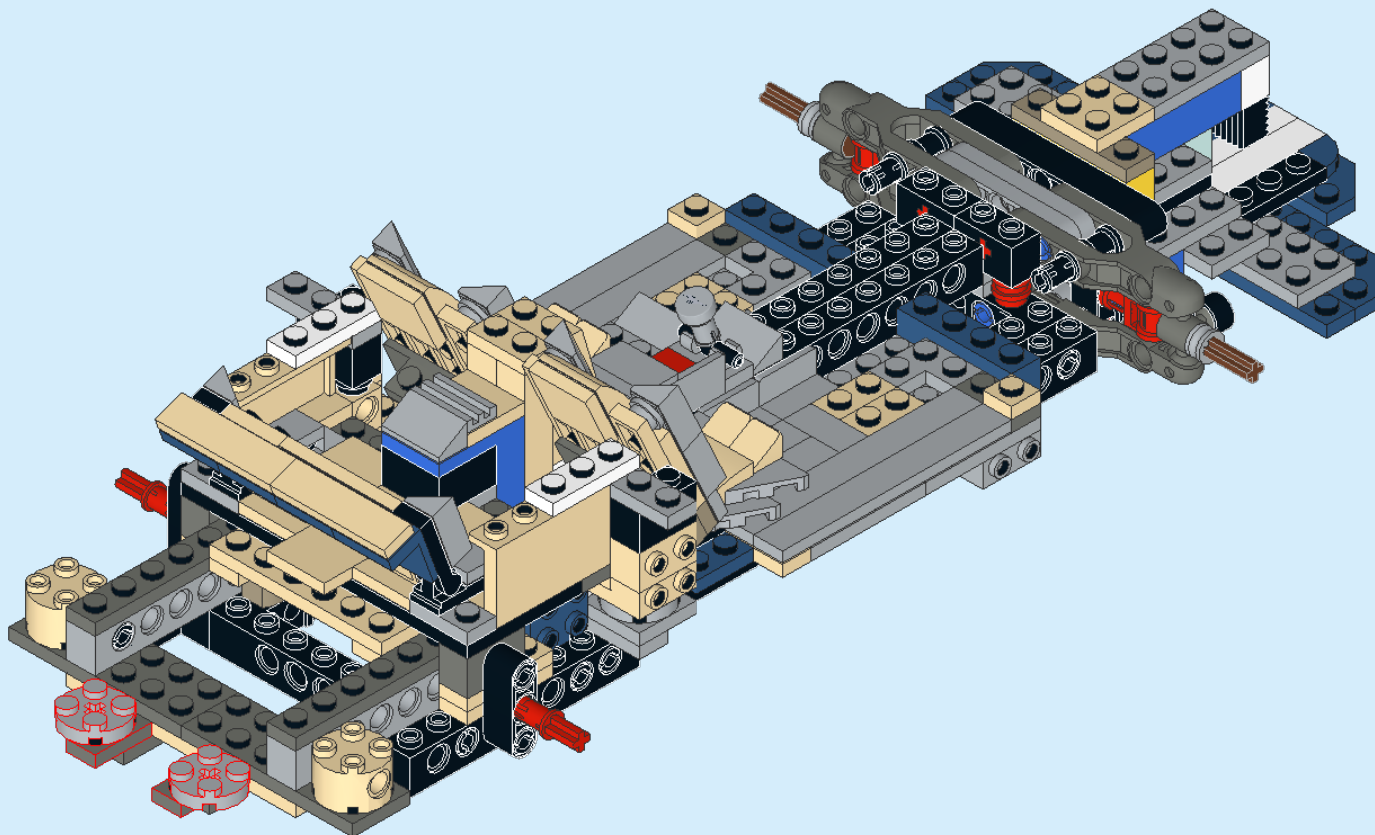

46

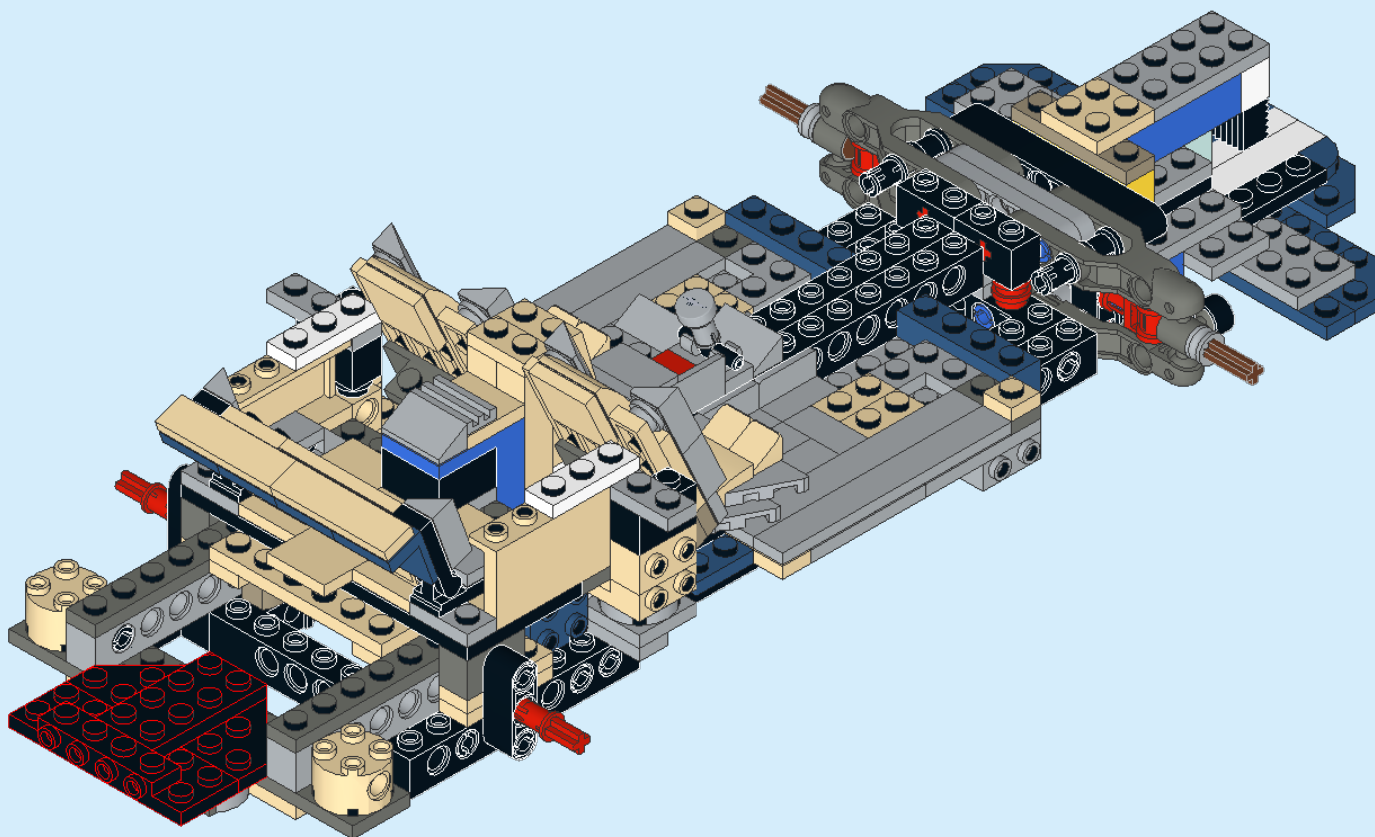
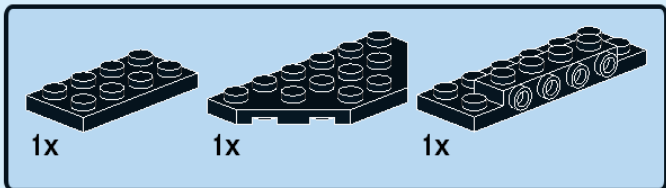

47

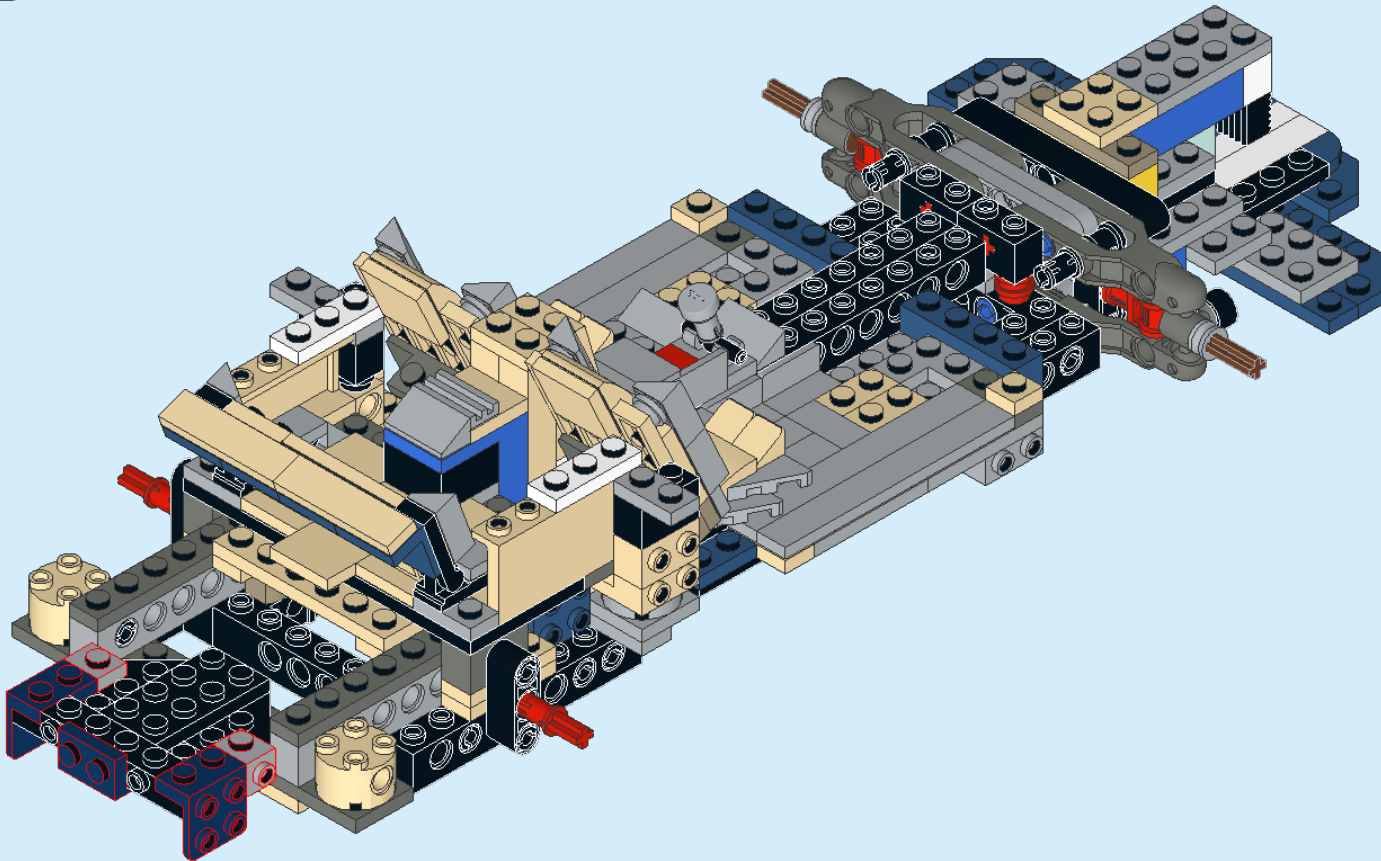
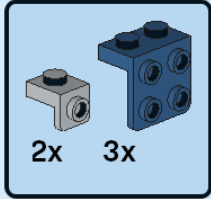

48

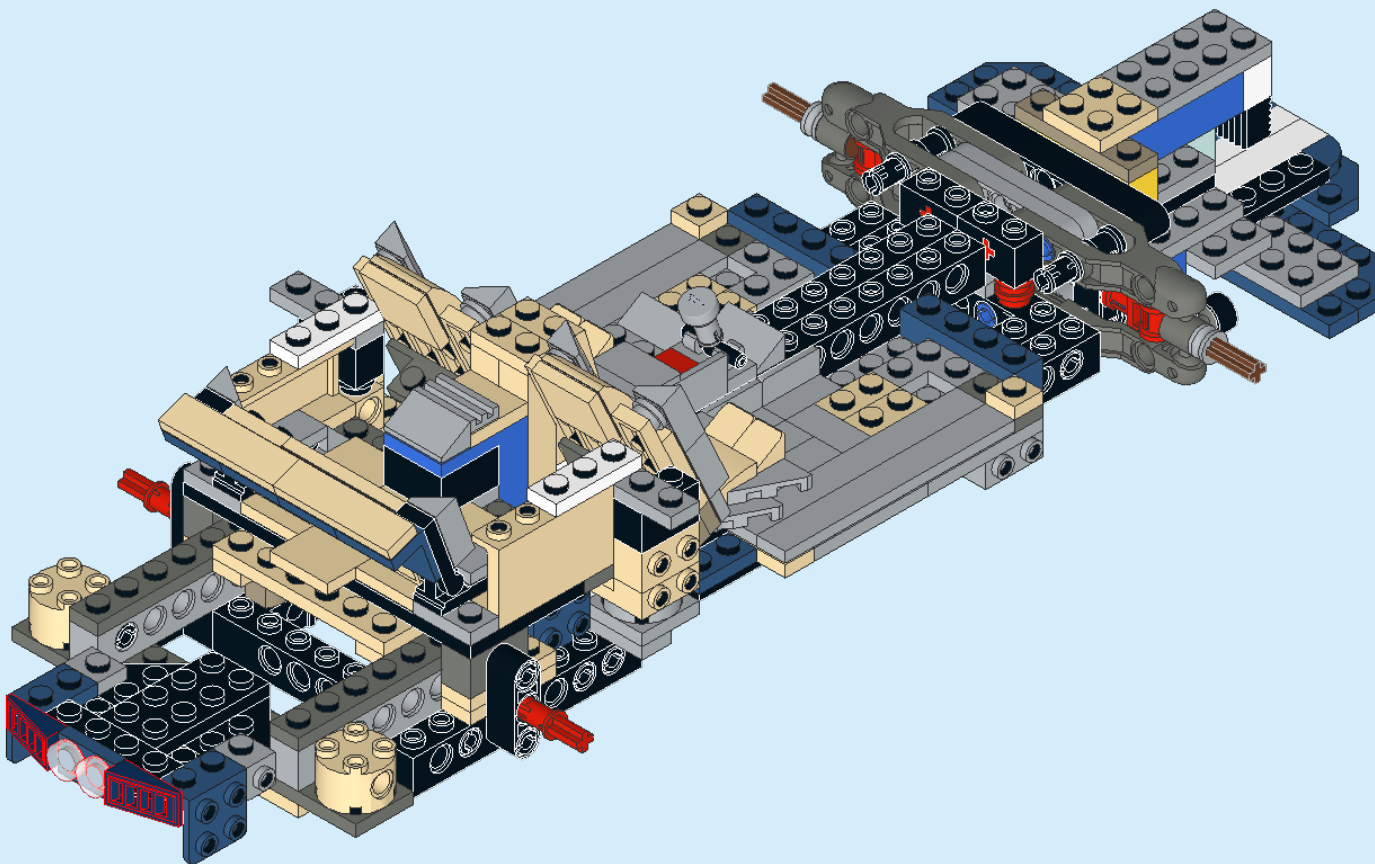
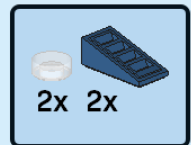

49

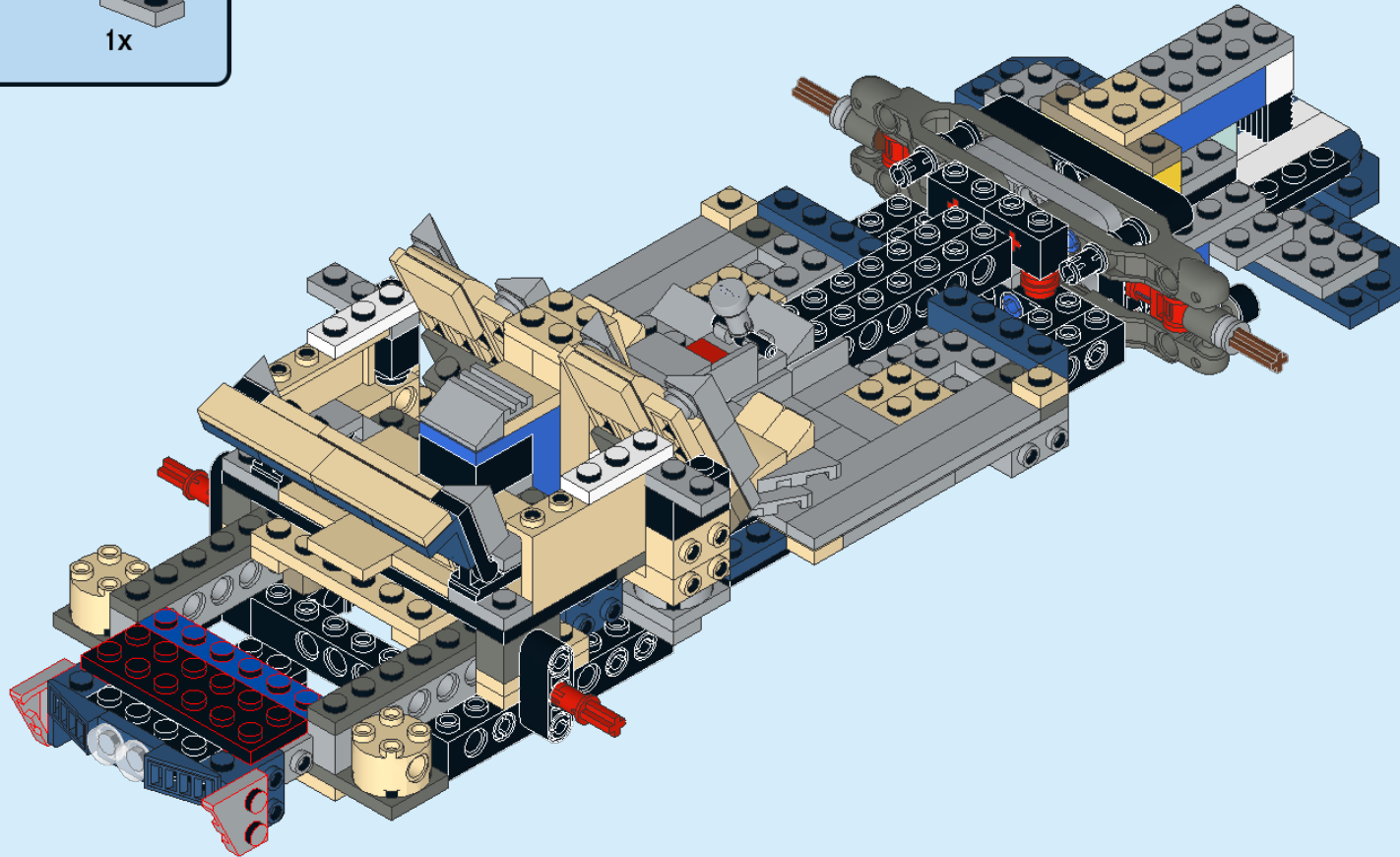
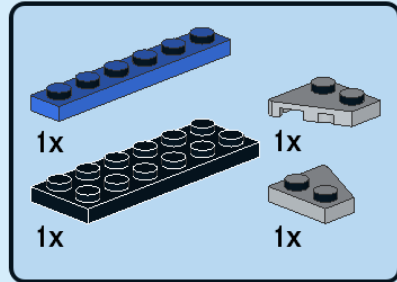

50

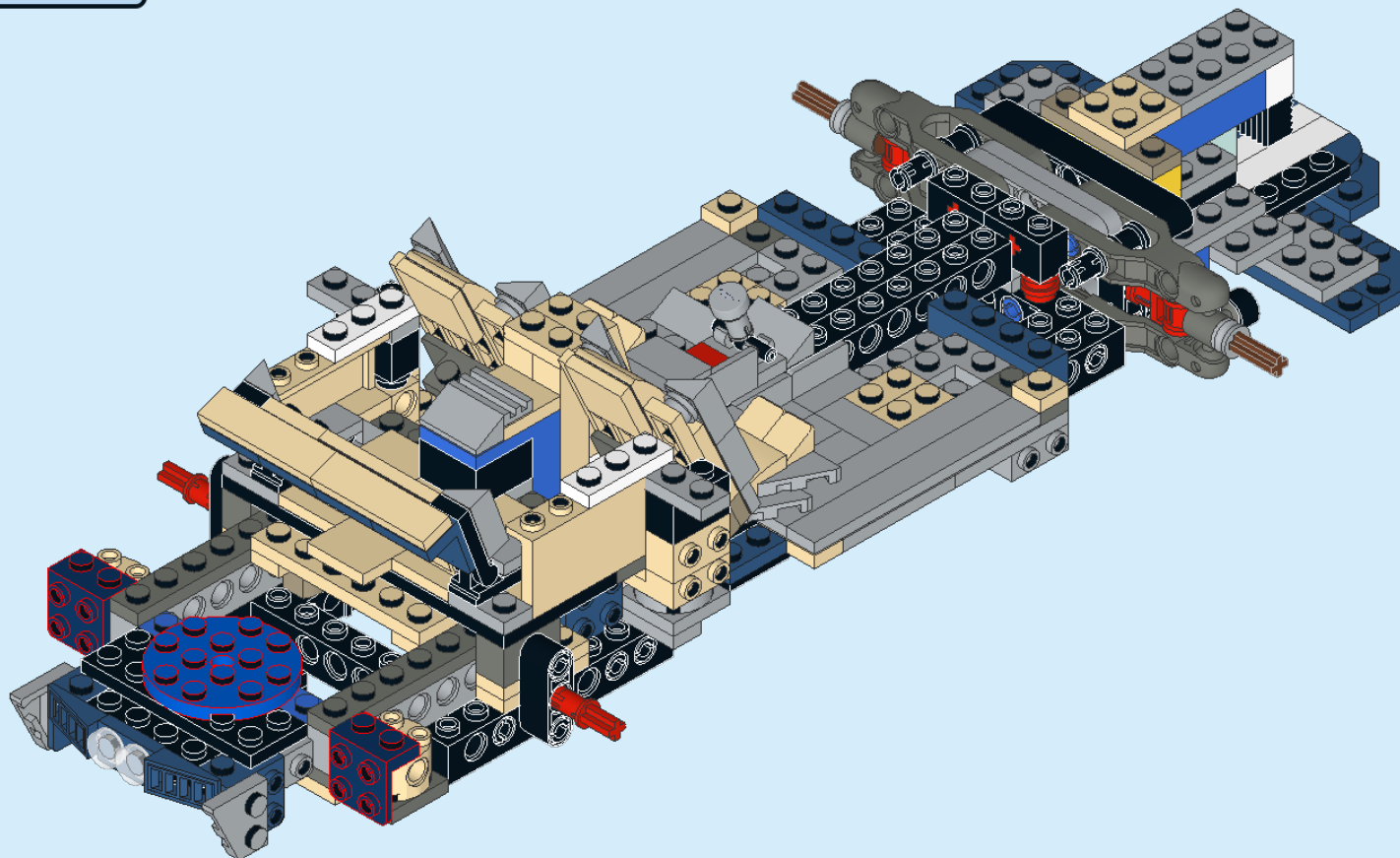
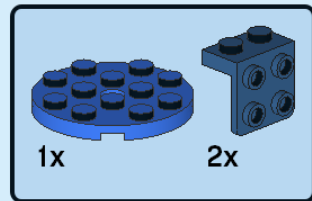

51

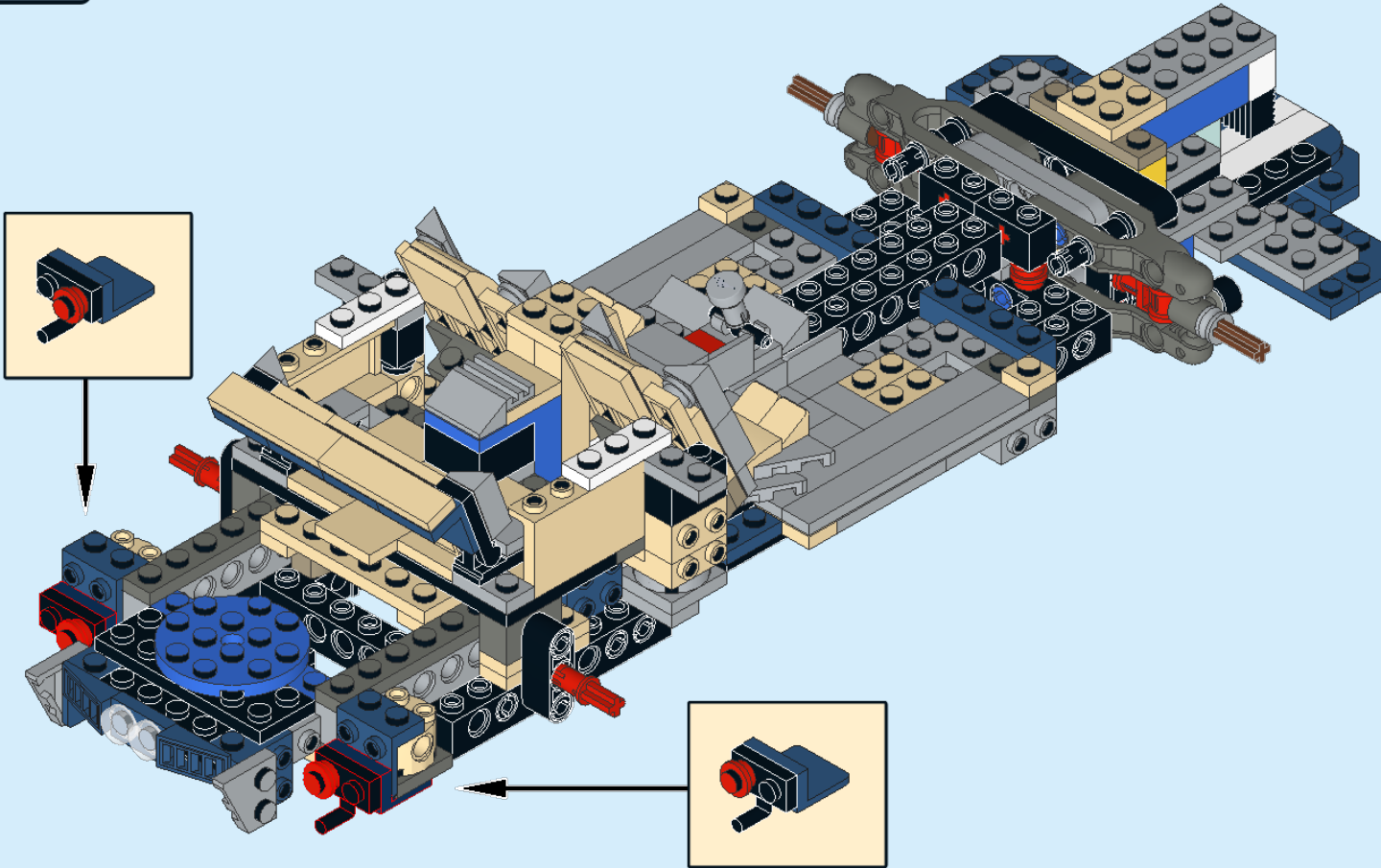
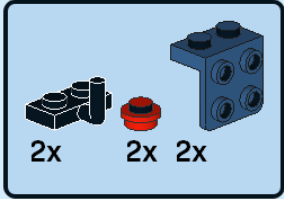

52

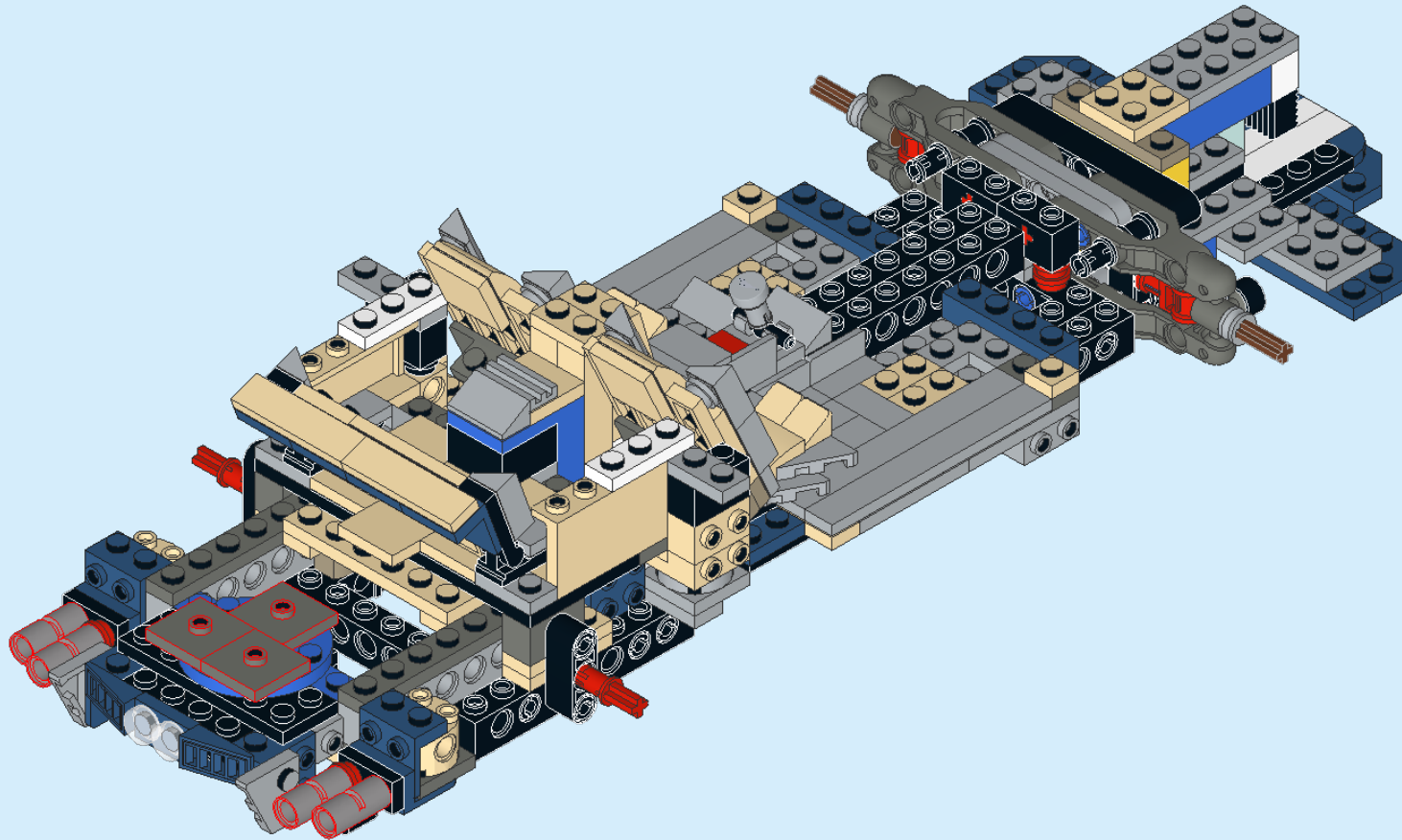
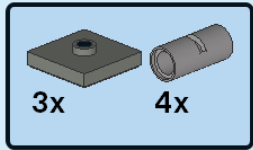

53

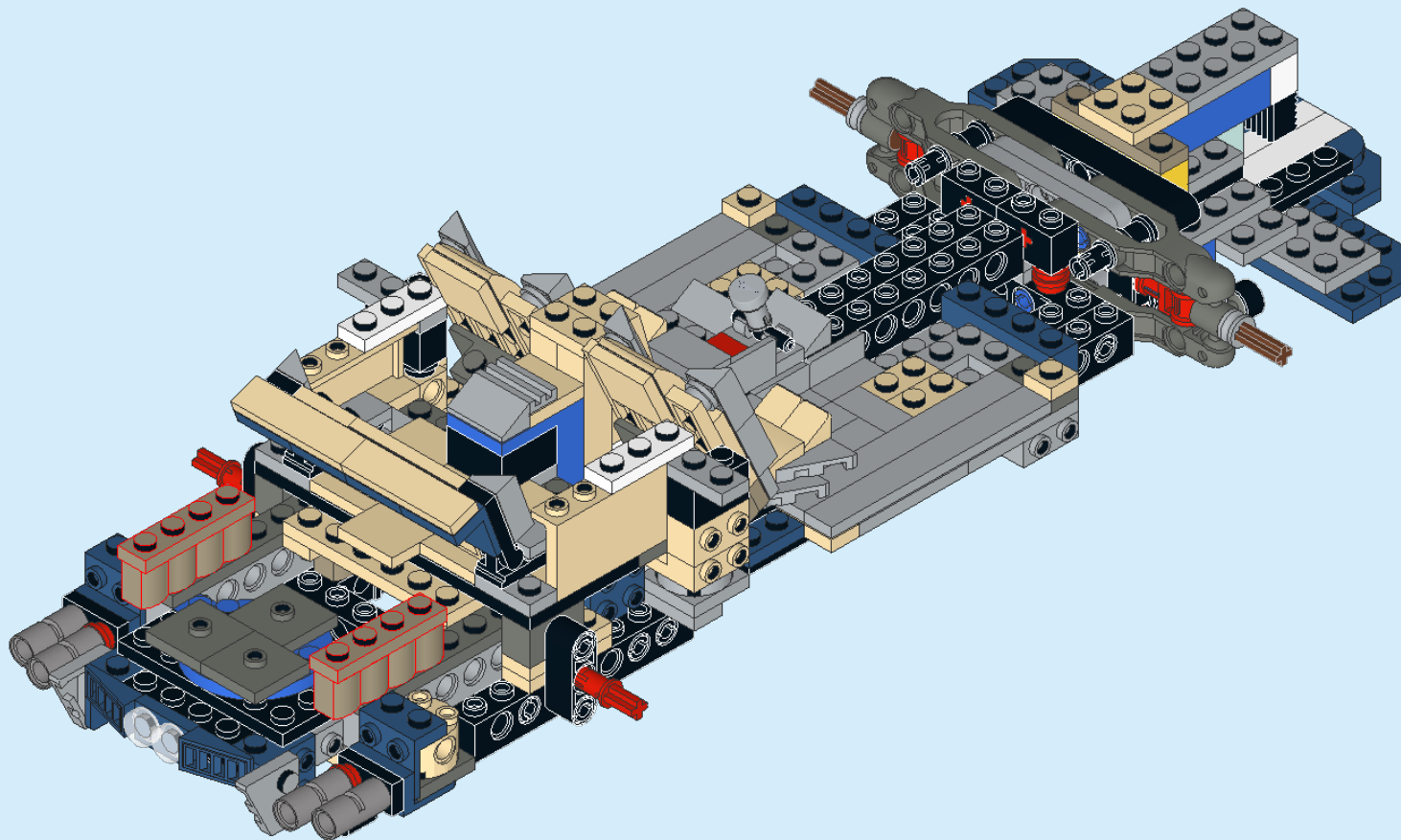
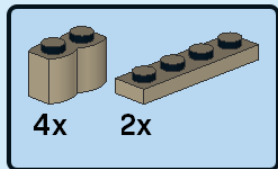

54

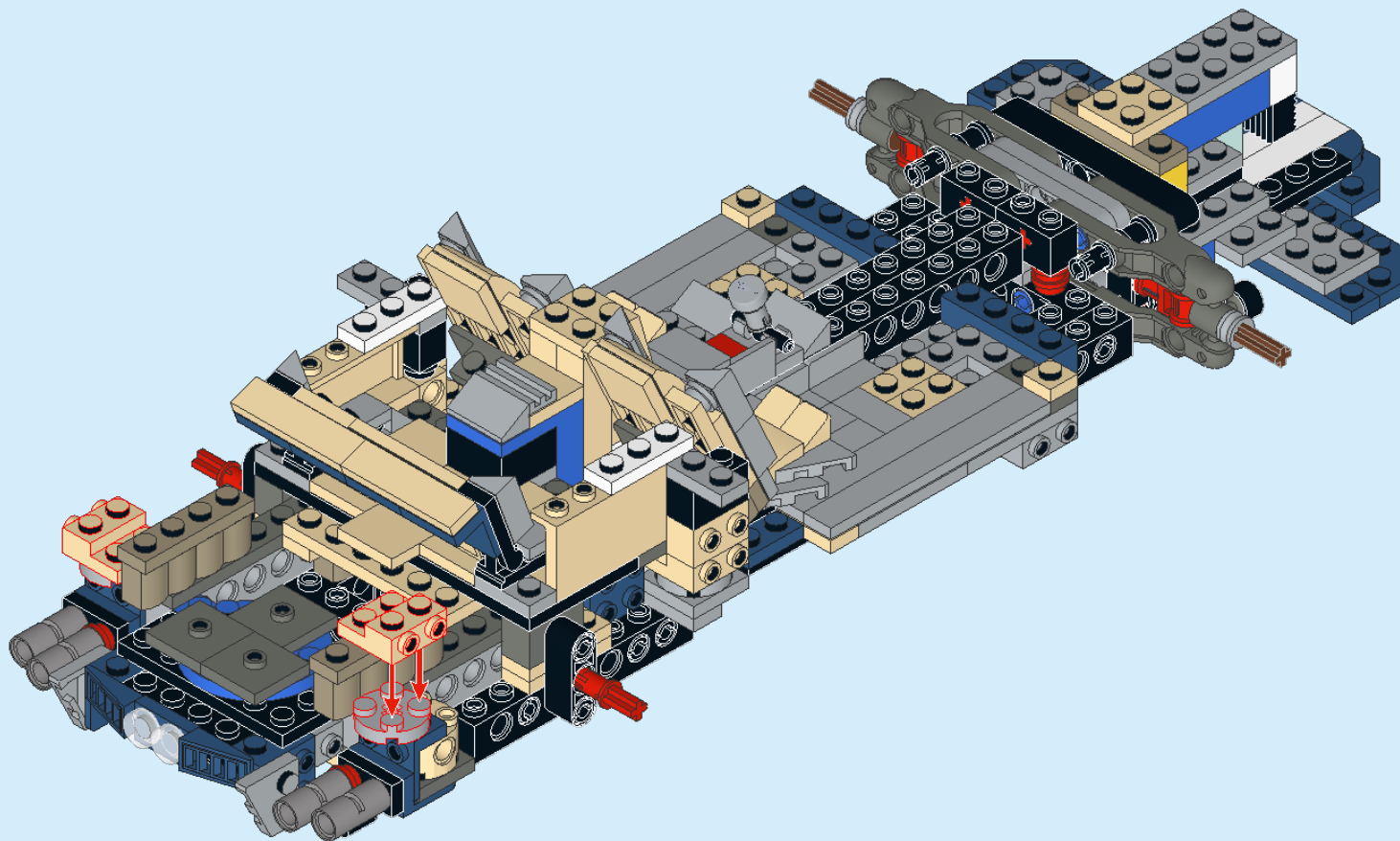
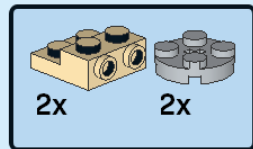

55

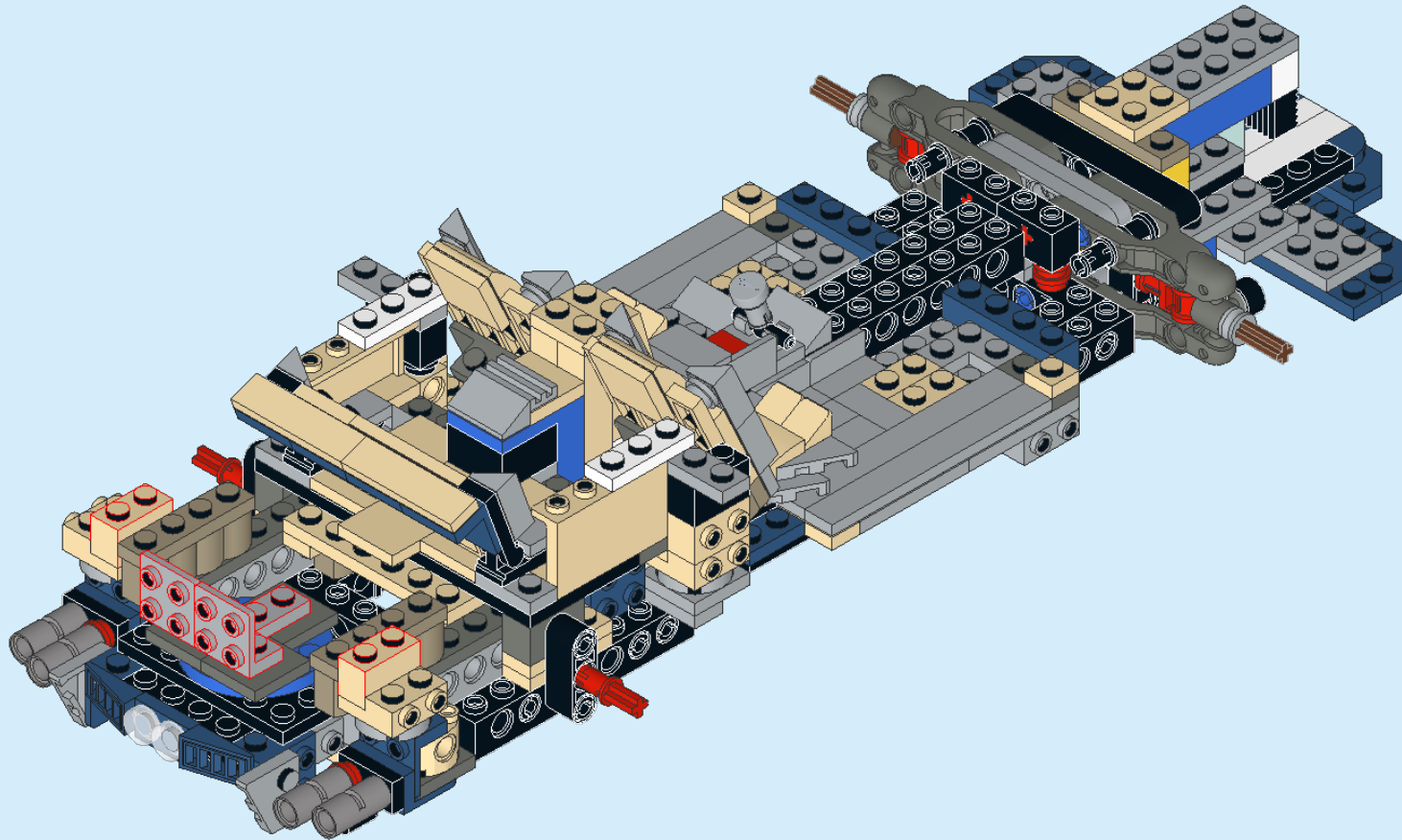
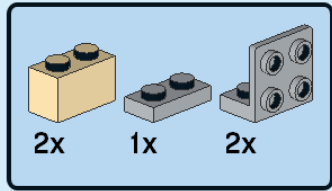

56

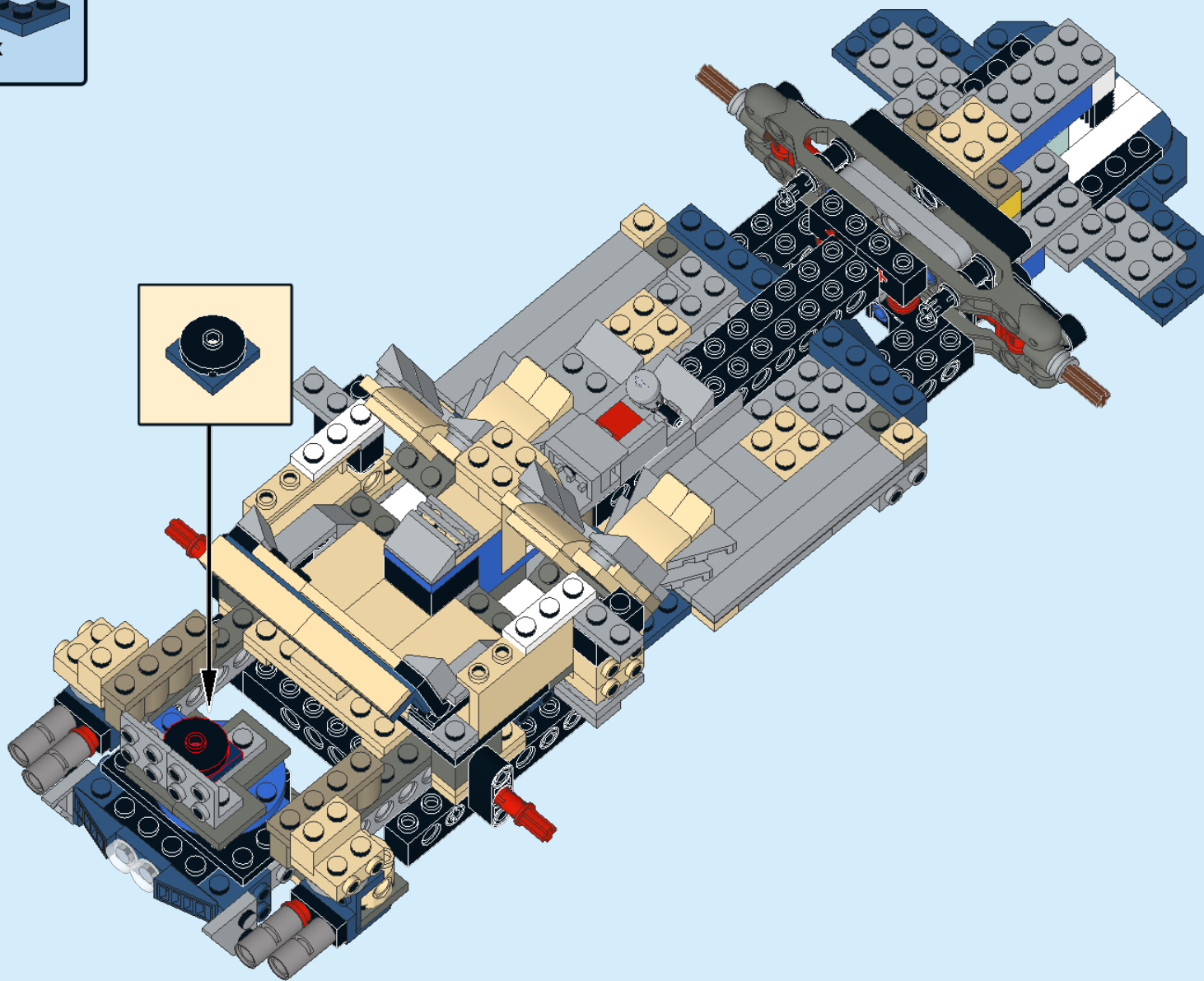
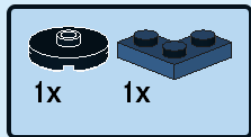

57

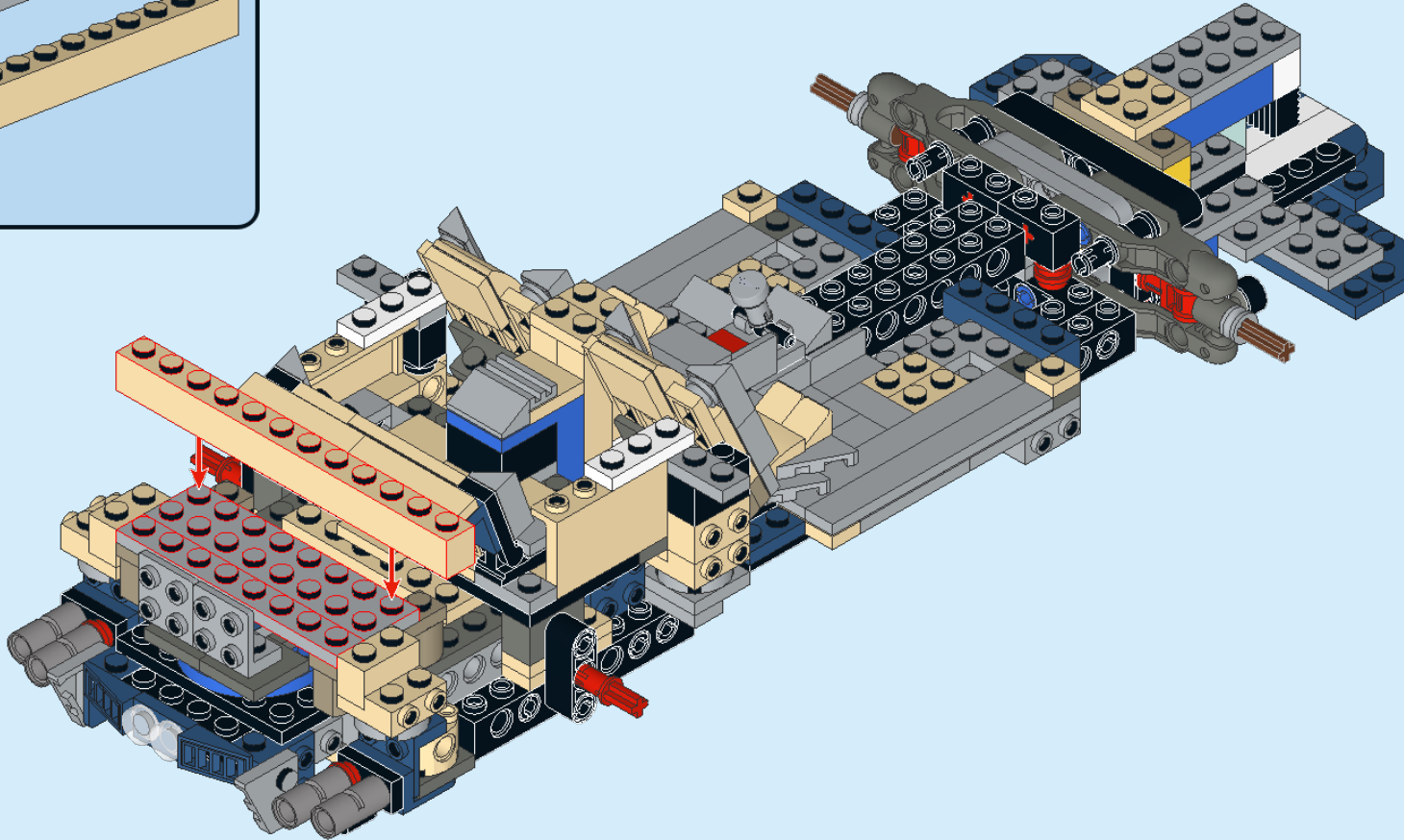
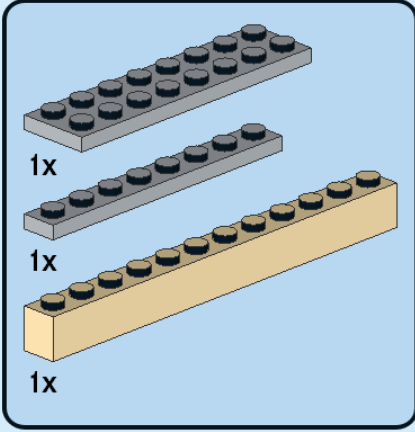

58

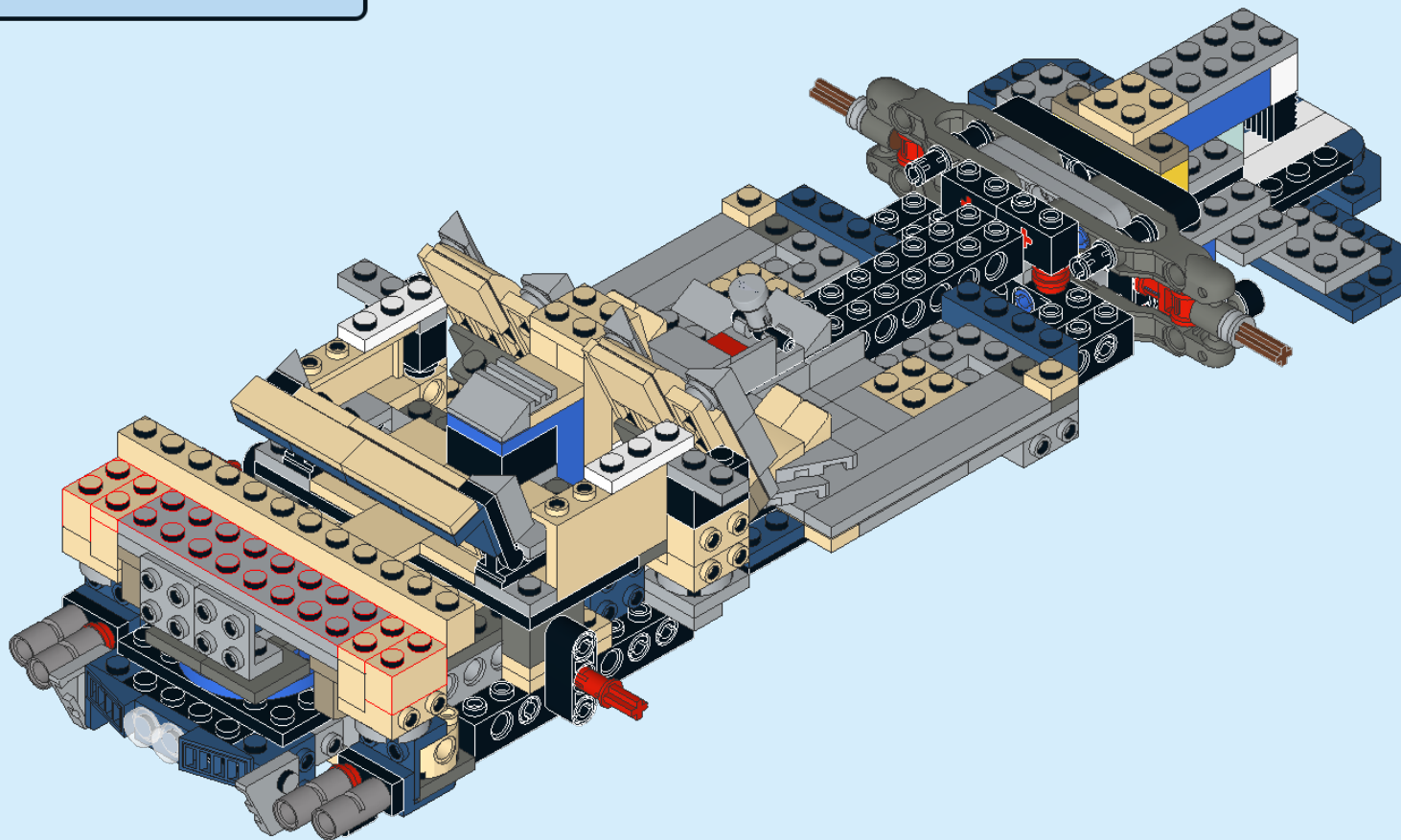
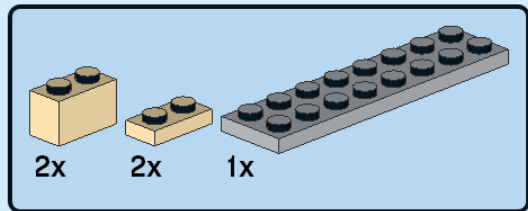

59

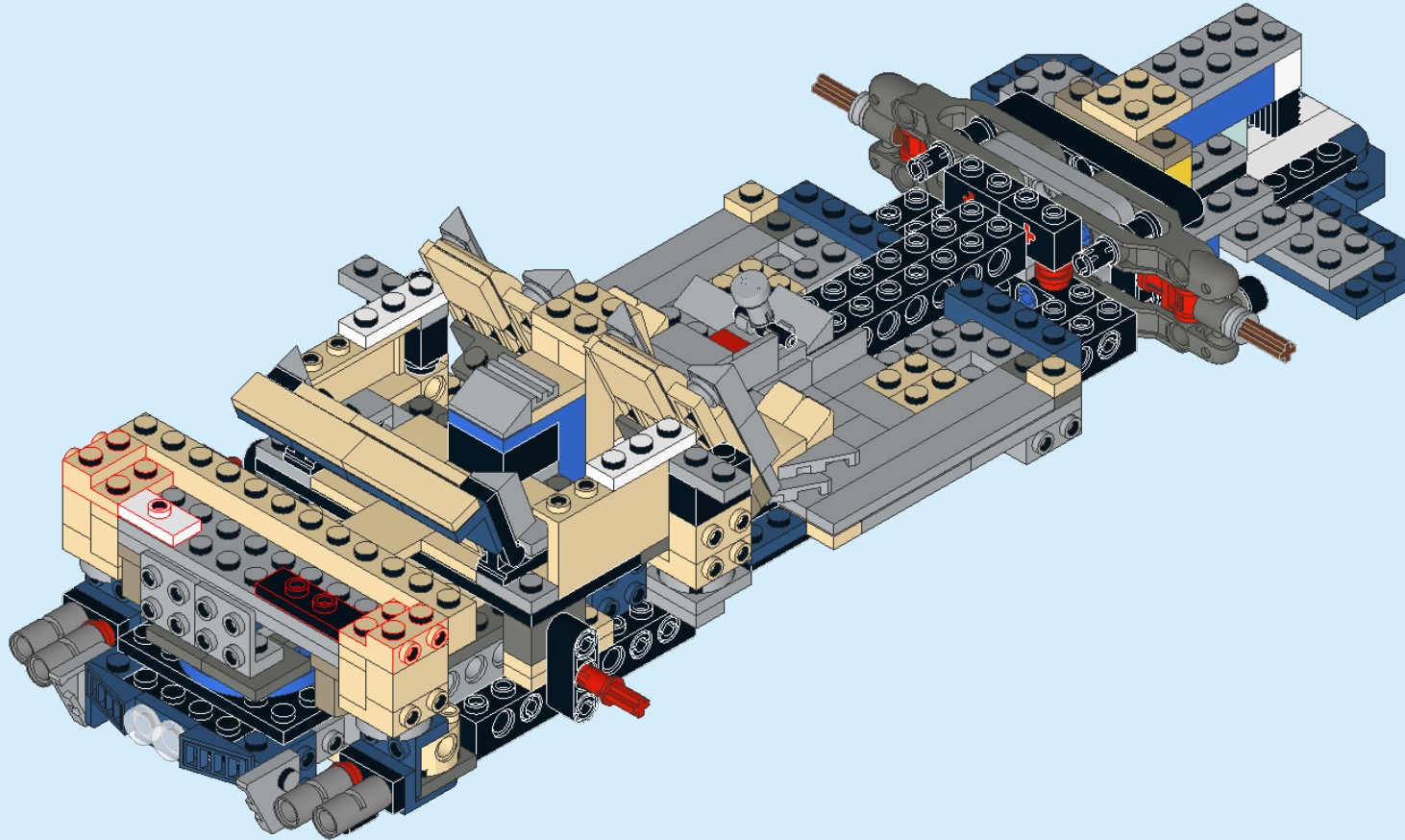
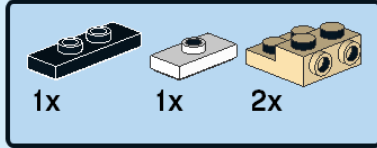

60

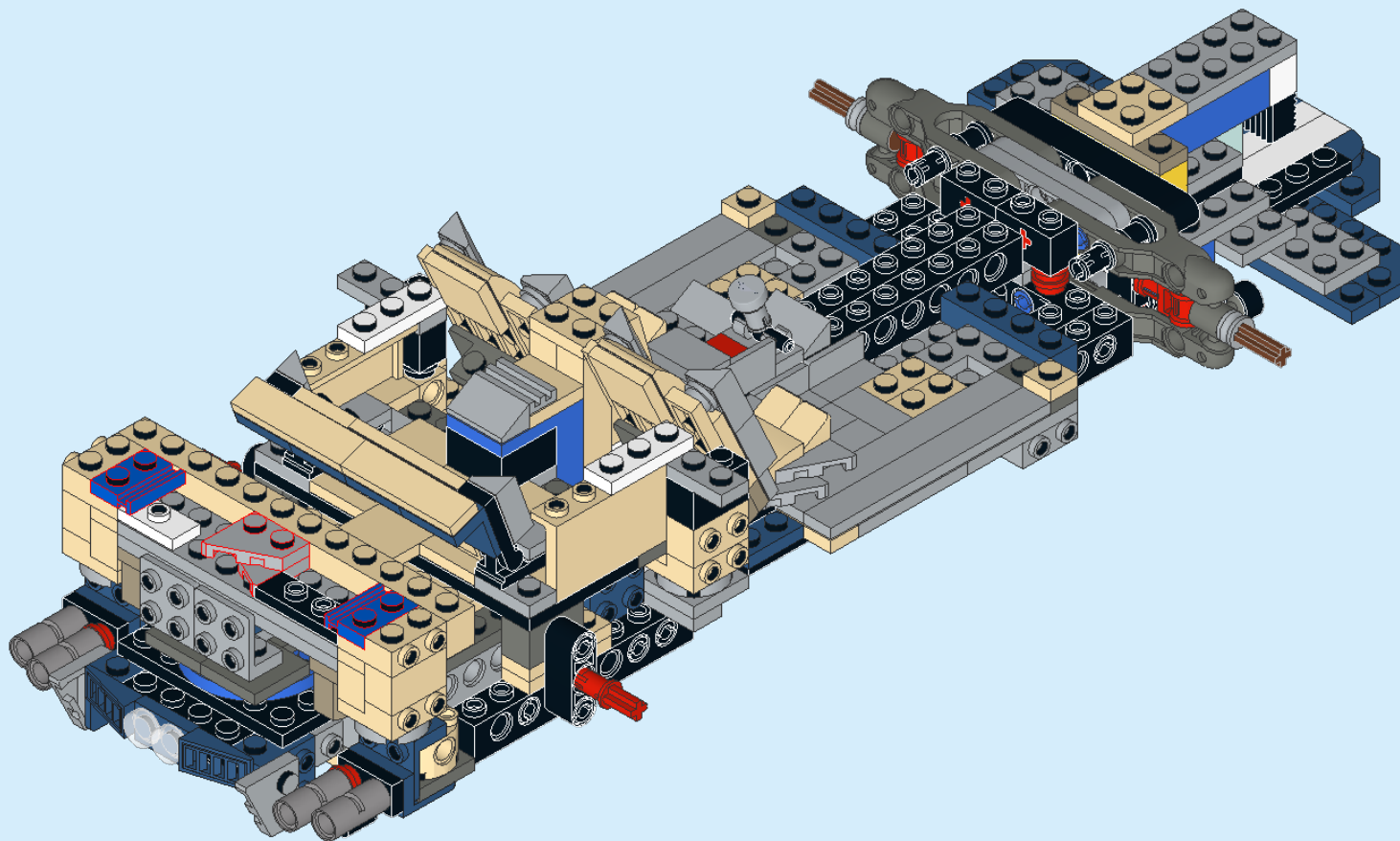
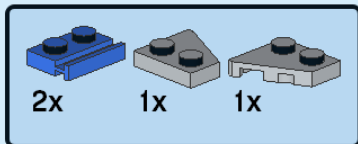

61

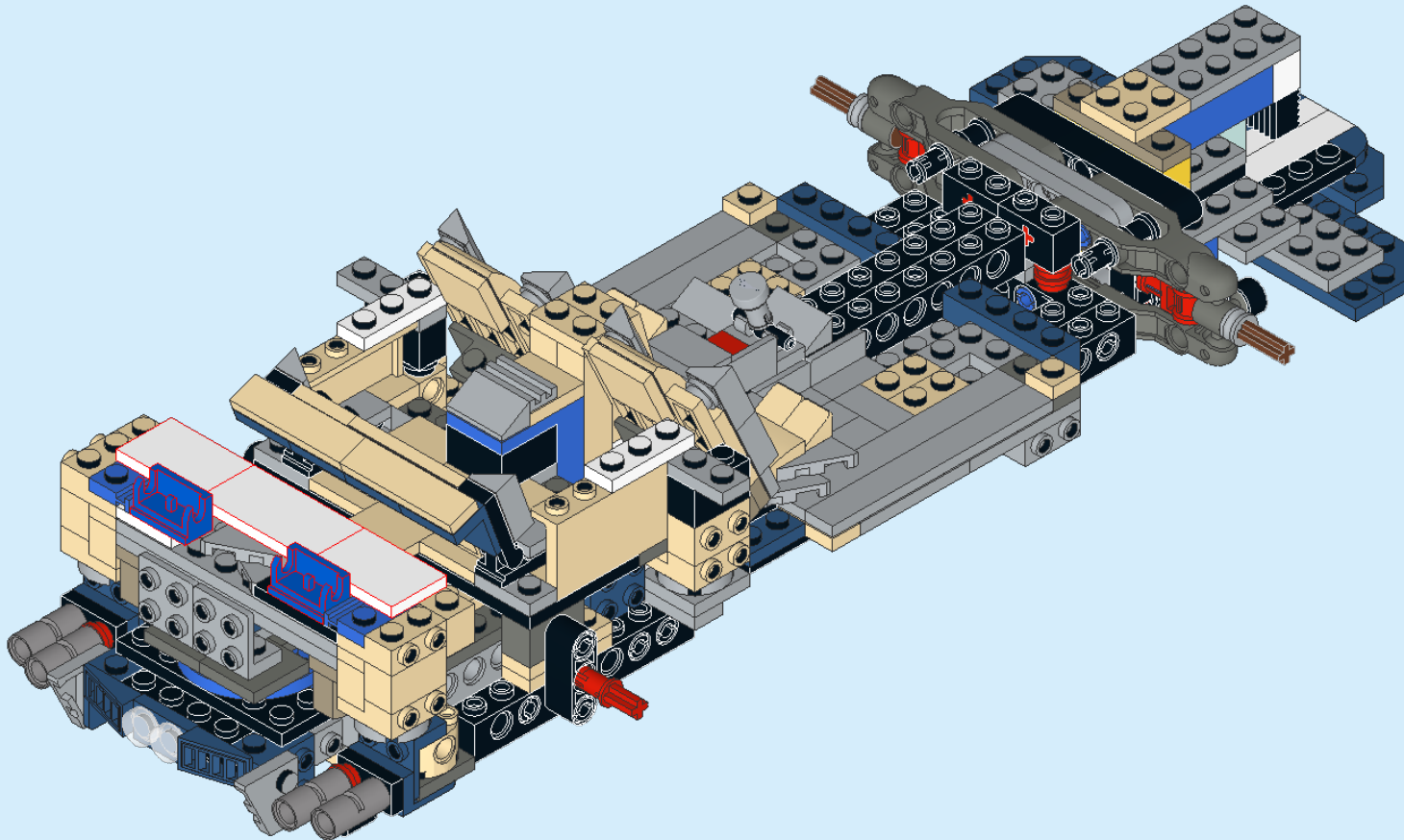
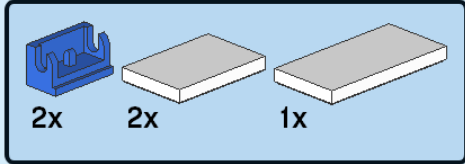

62

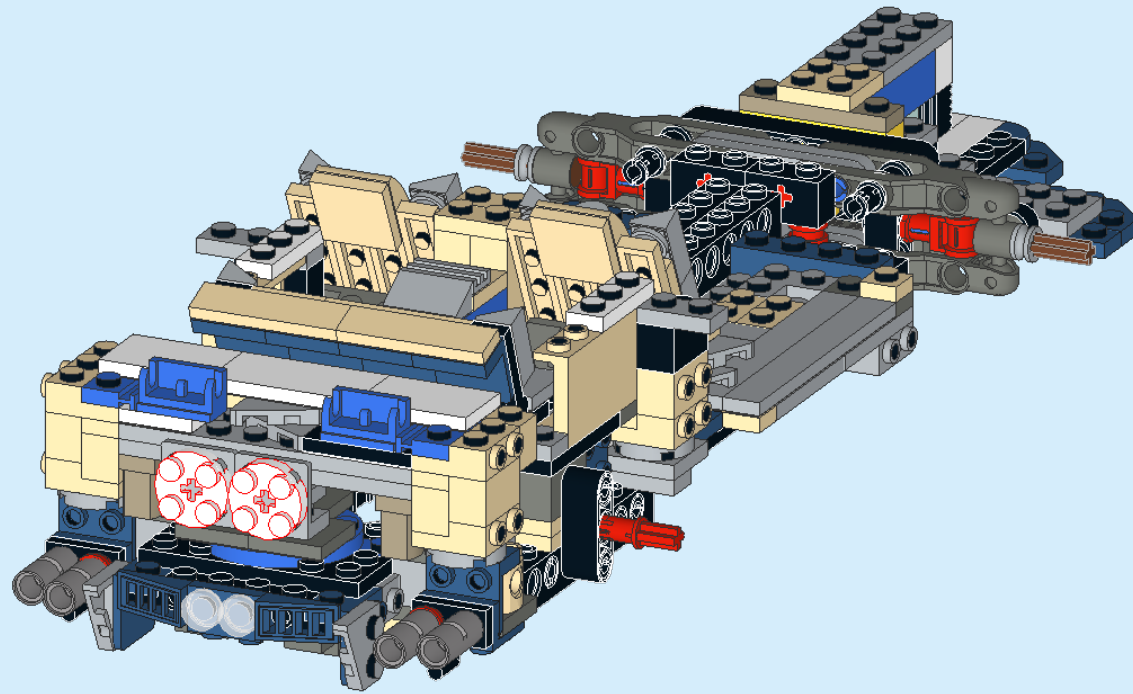
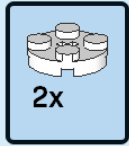

63

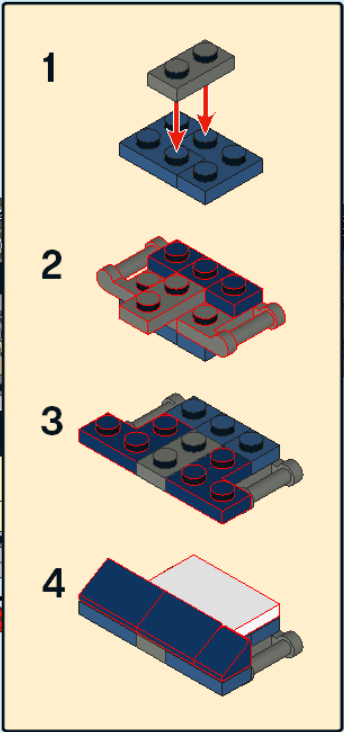
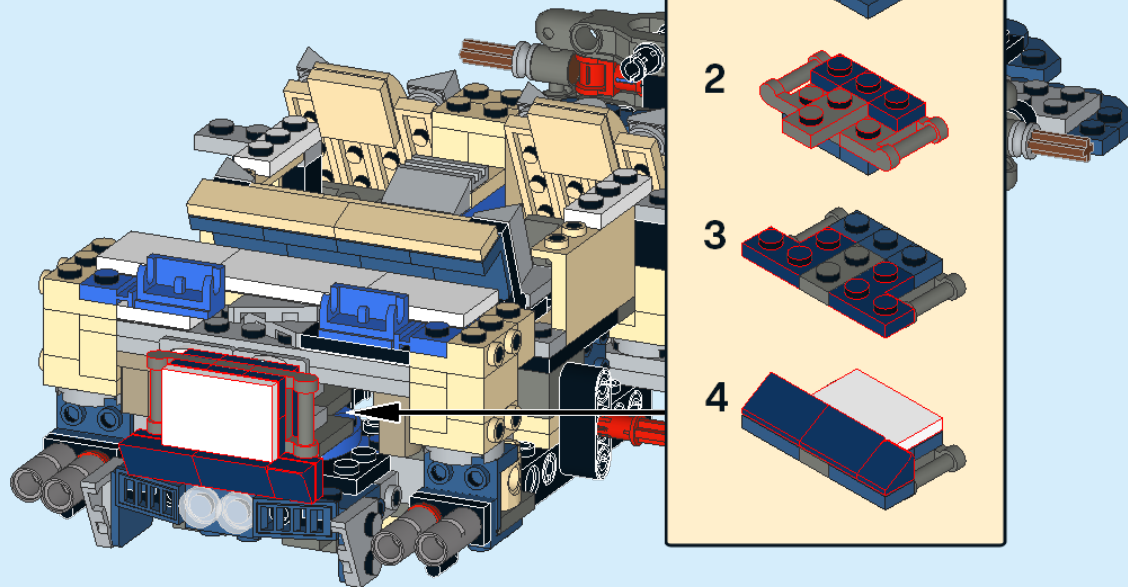

64

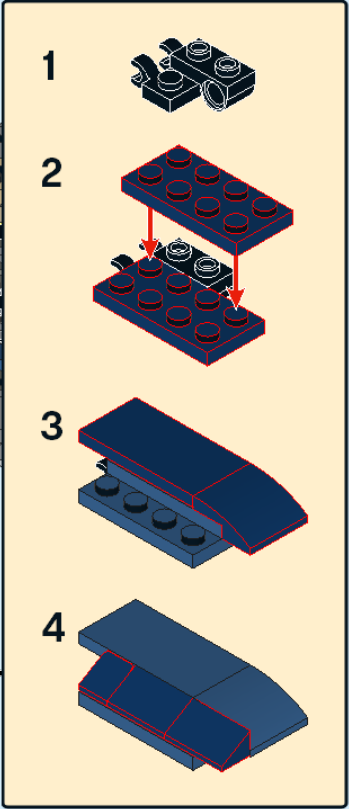
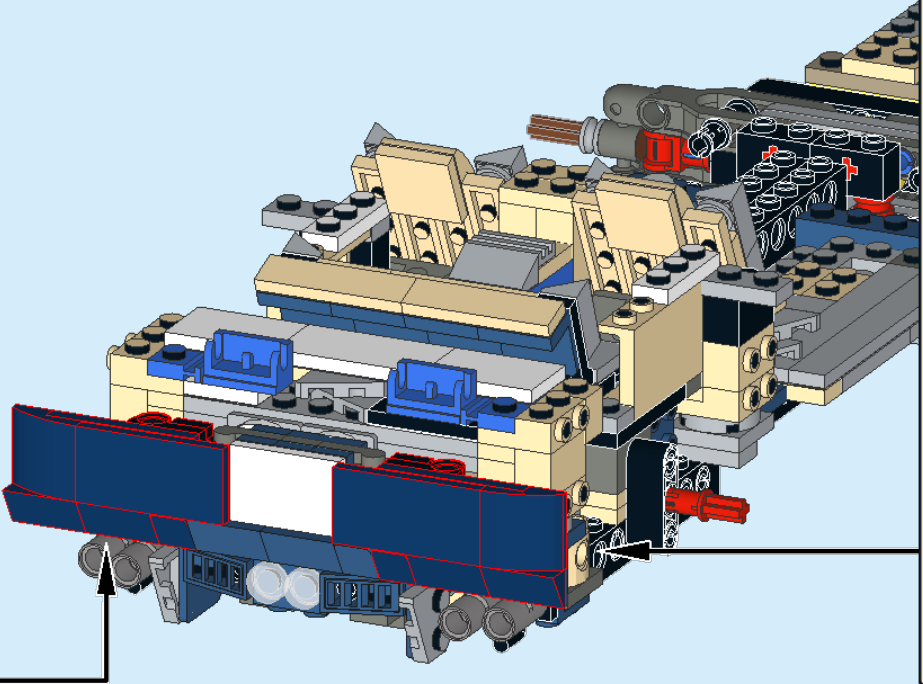
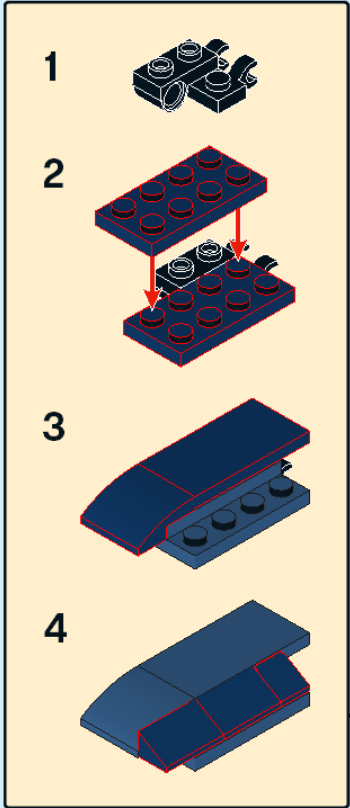
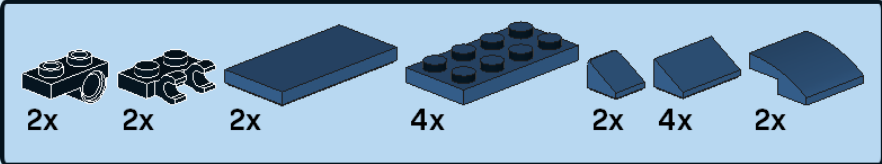

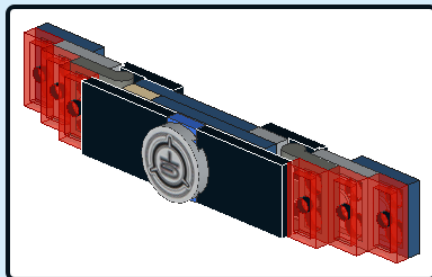

1

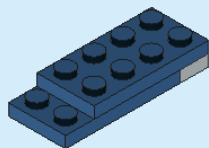
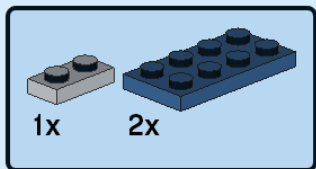

2

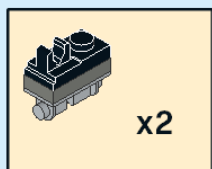
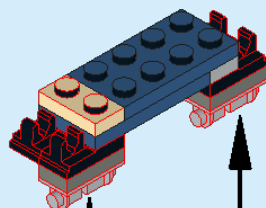
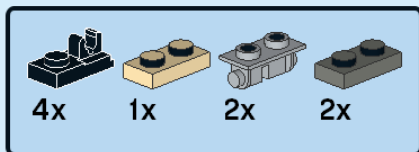

3

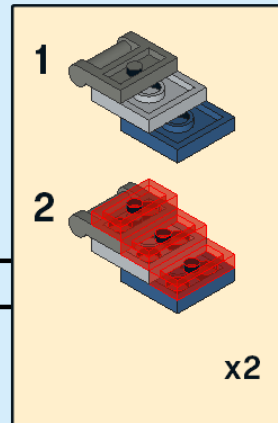
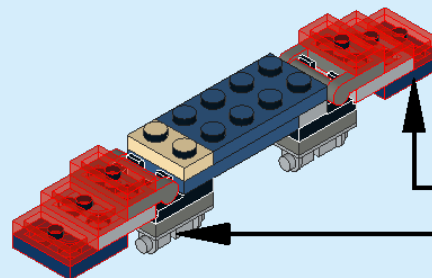
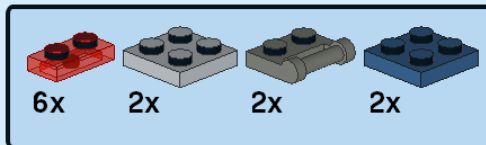

4

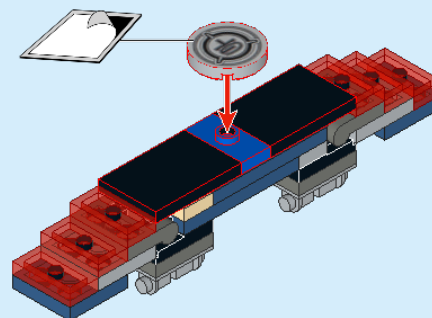
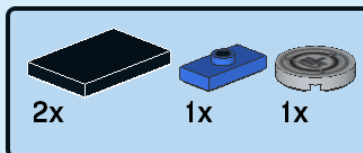

65

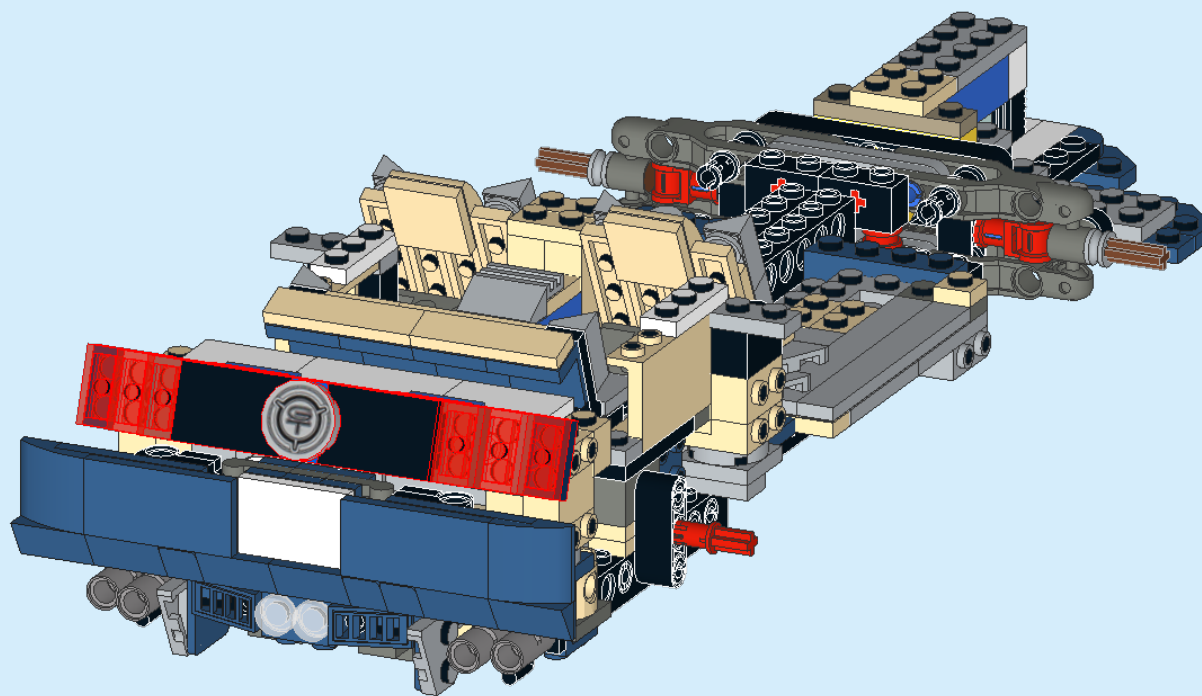

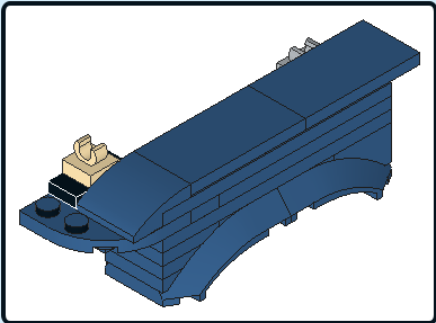

1

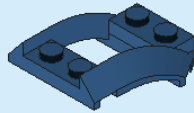
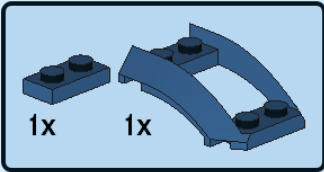

2

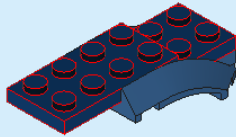
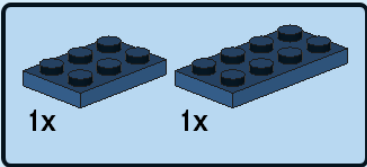

3

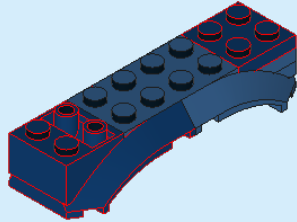
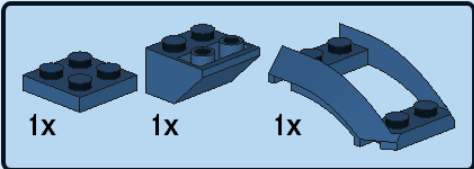

4

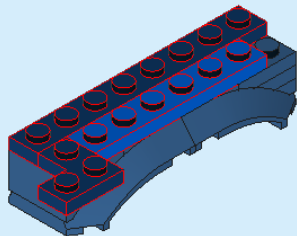
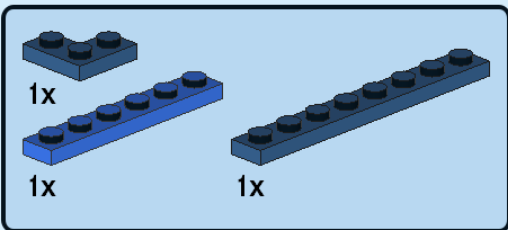

5

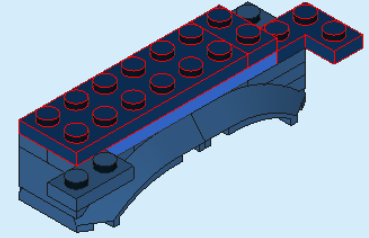
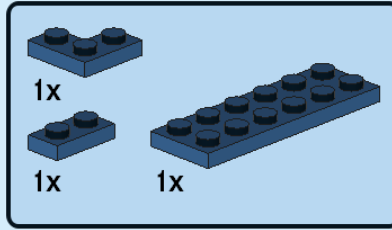

6

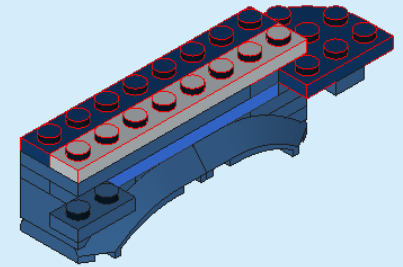
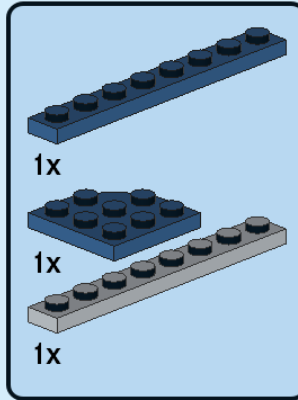

7

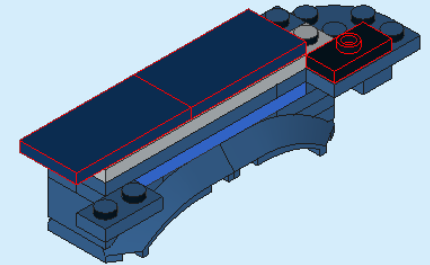
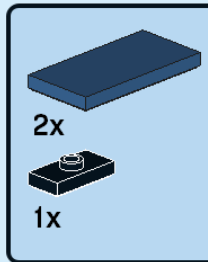

8

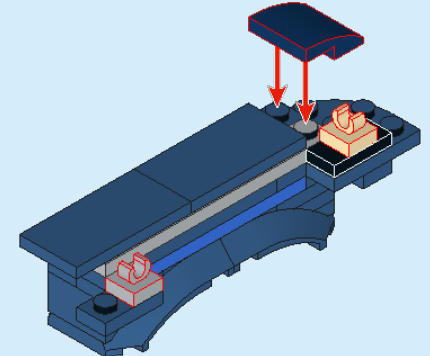
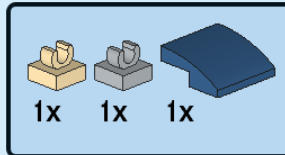

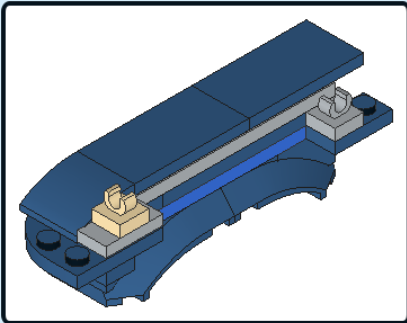

1

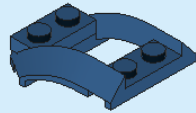
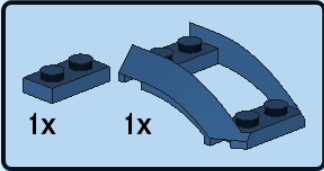

2

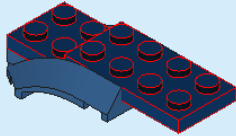
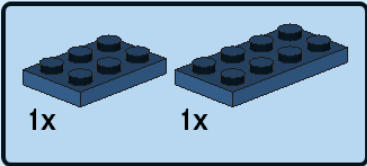

3

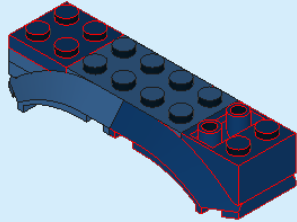
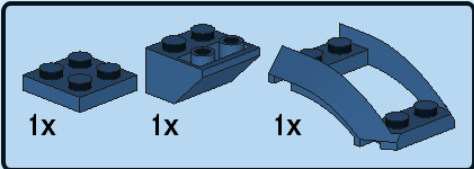

4

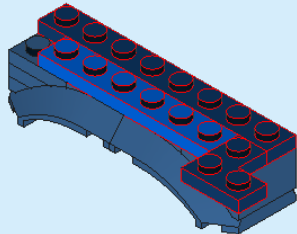
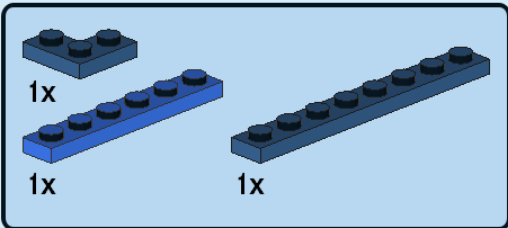

5

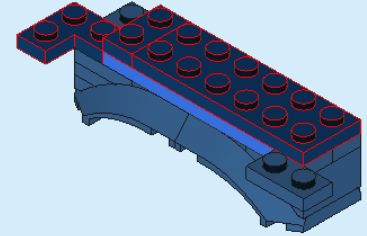
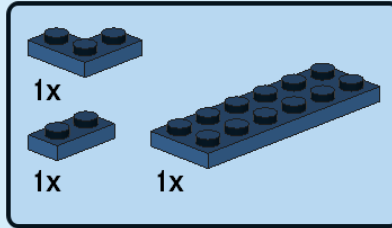

6

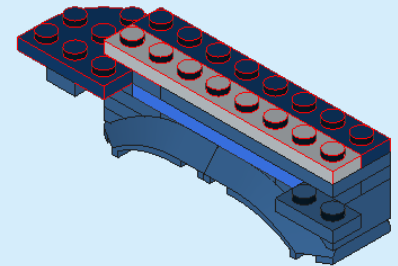
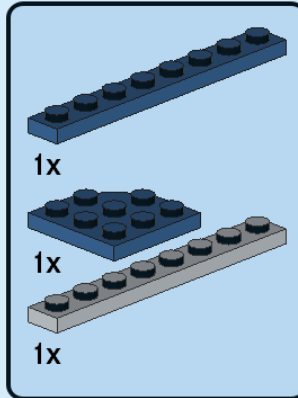

7

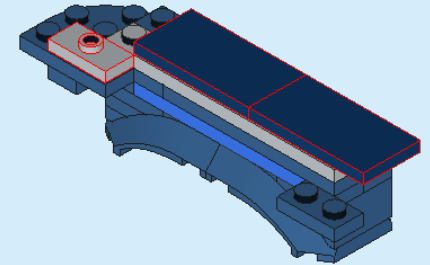
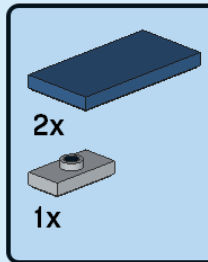

8

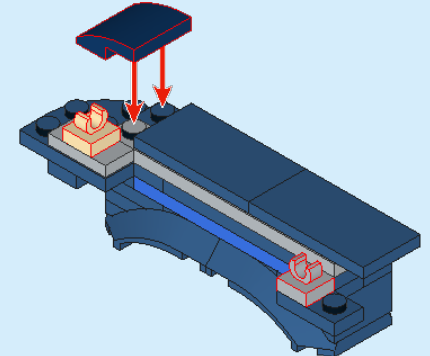
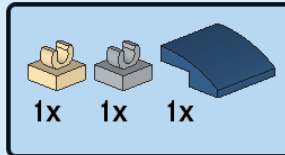

66

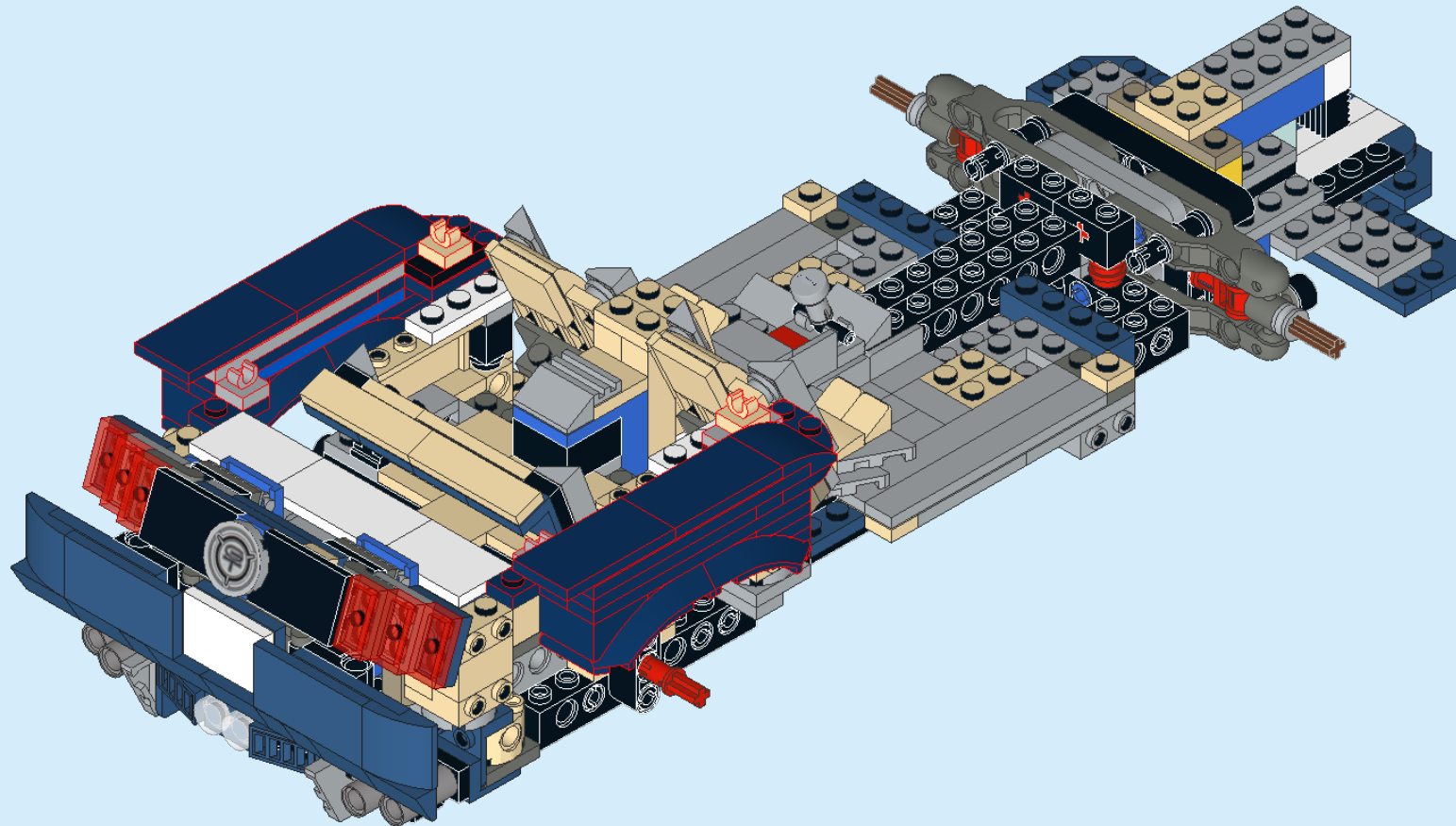

67

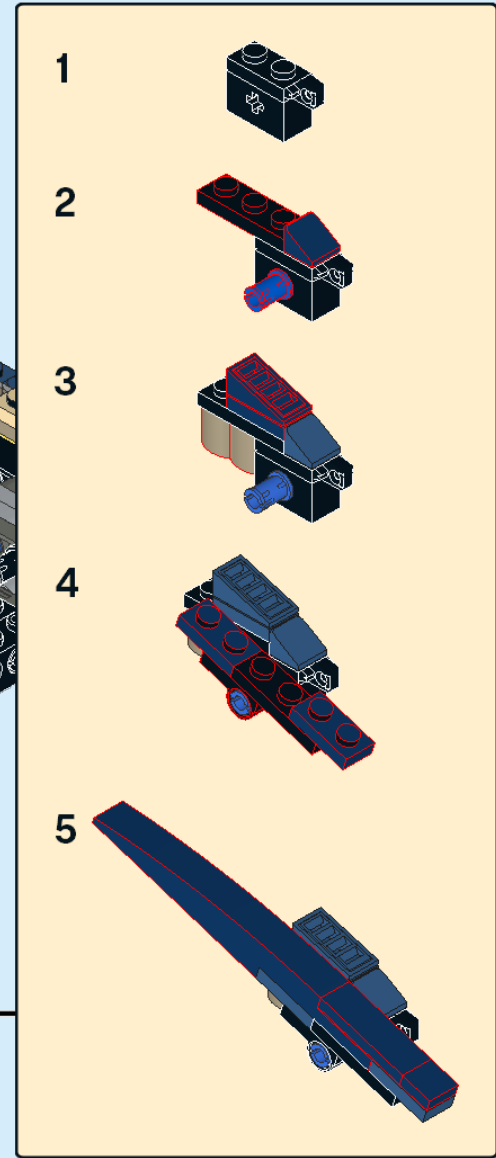
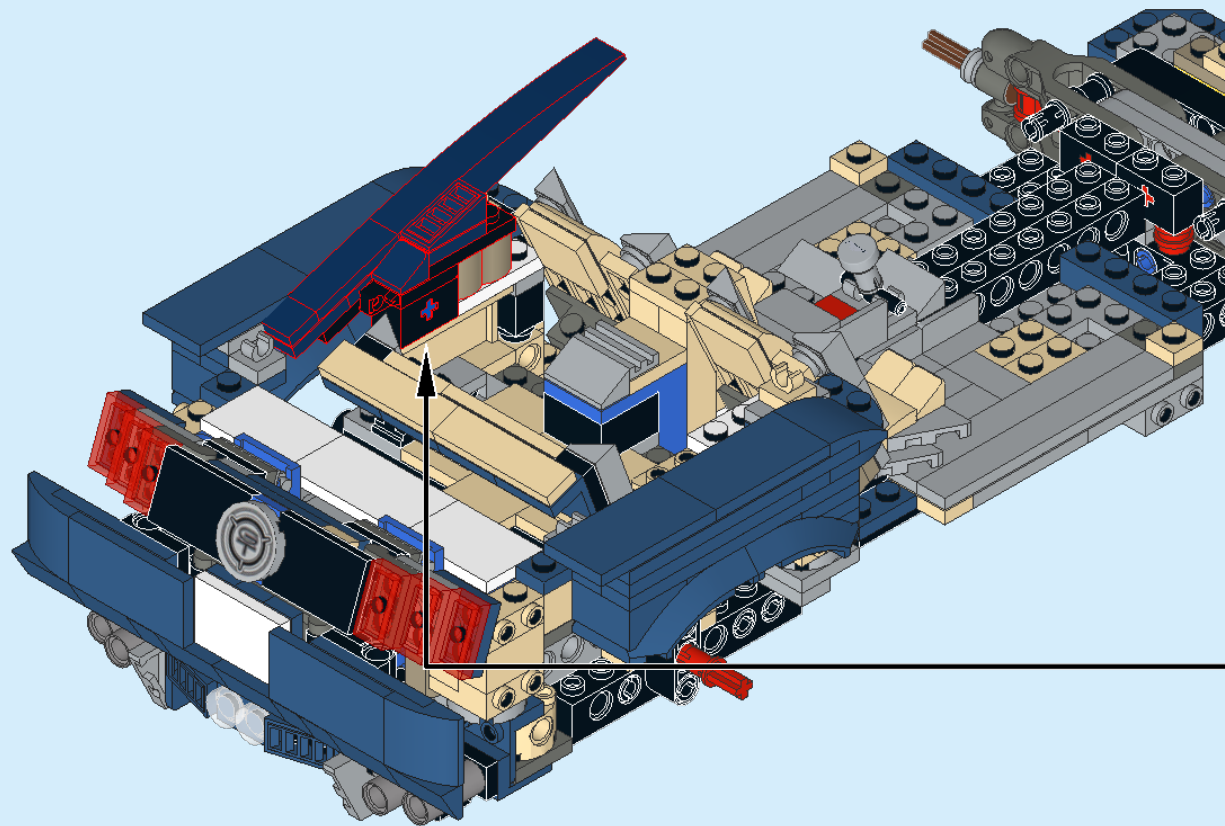
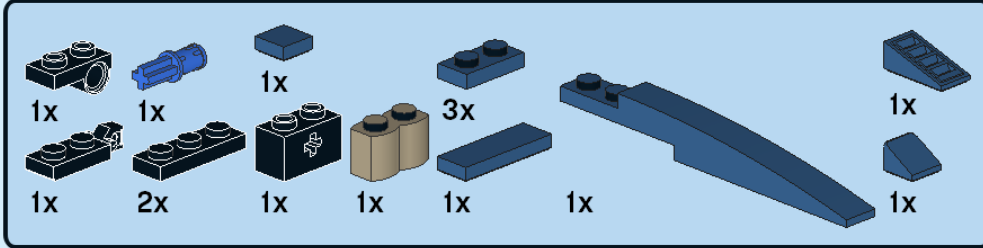

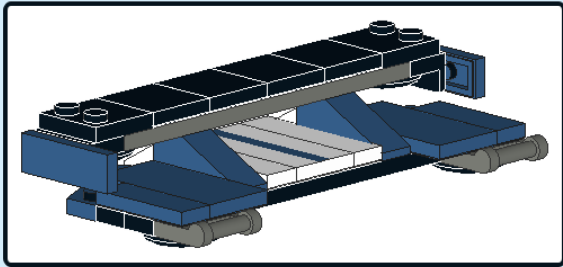

1

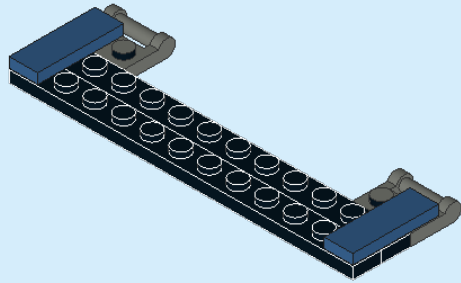
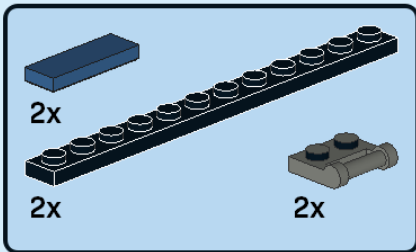

2

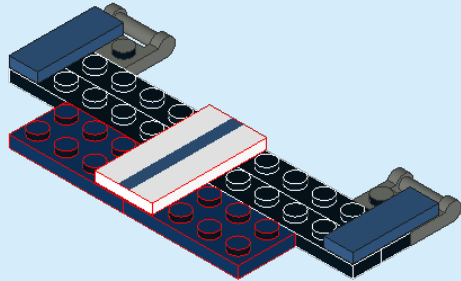
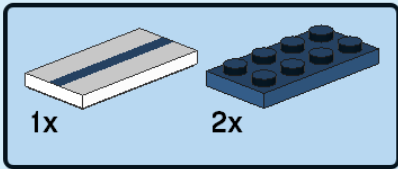

3

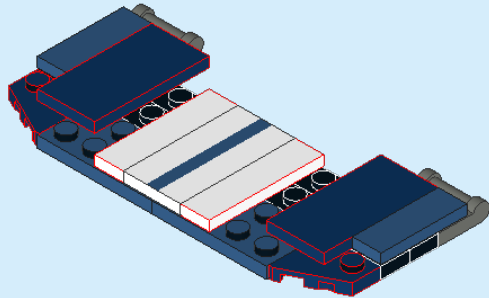
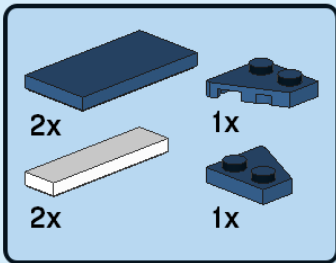

4

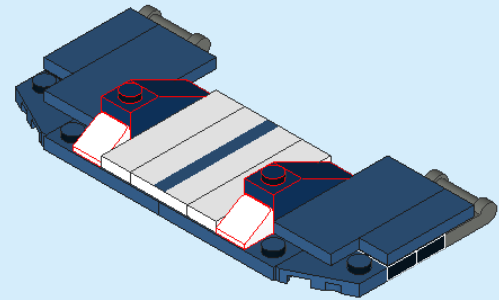
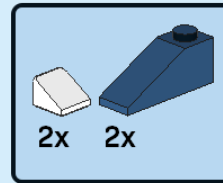

5

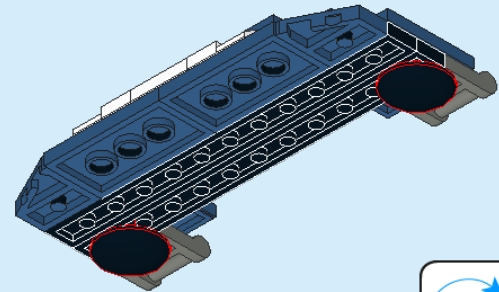

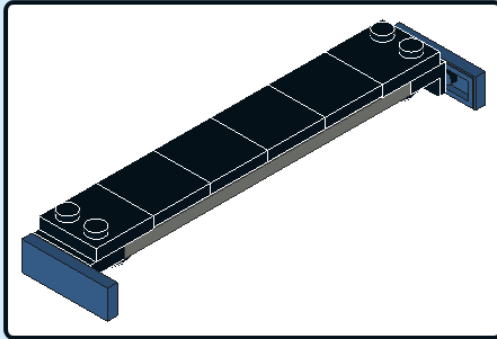

1

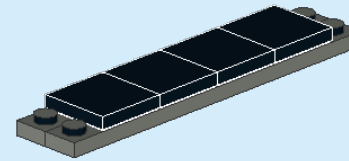
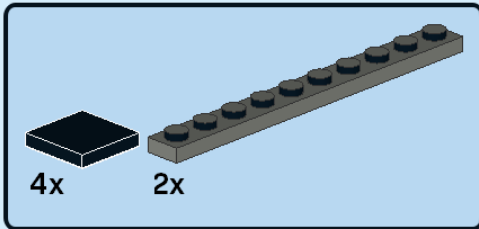

2

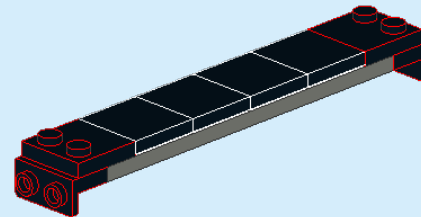
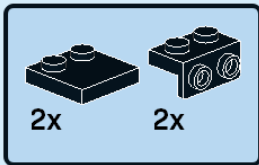

3

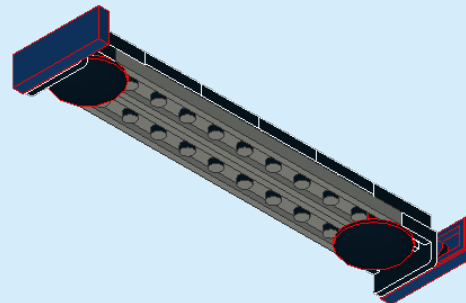
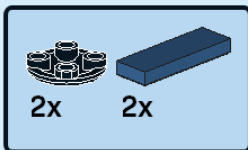

6

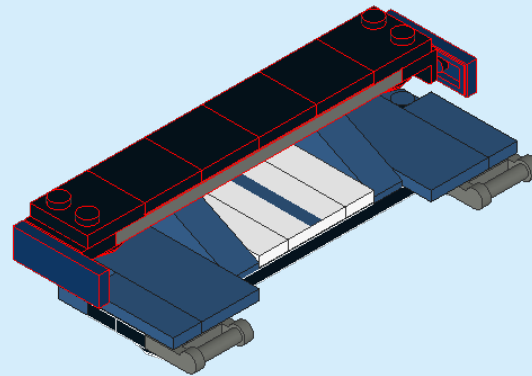

71

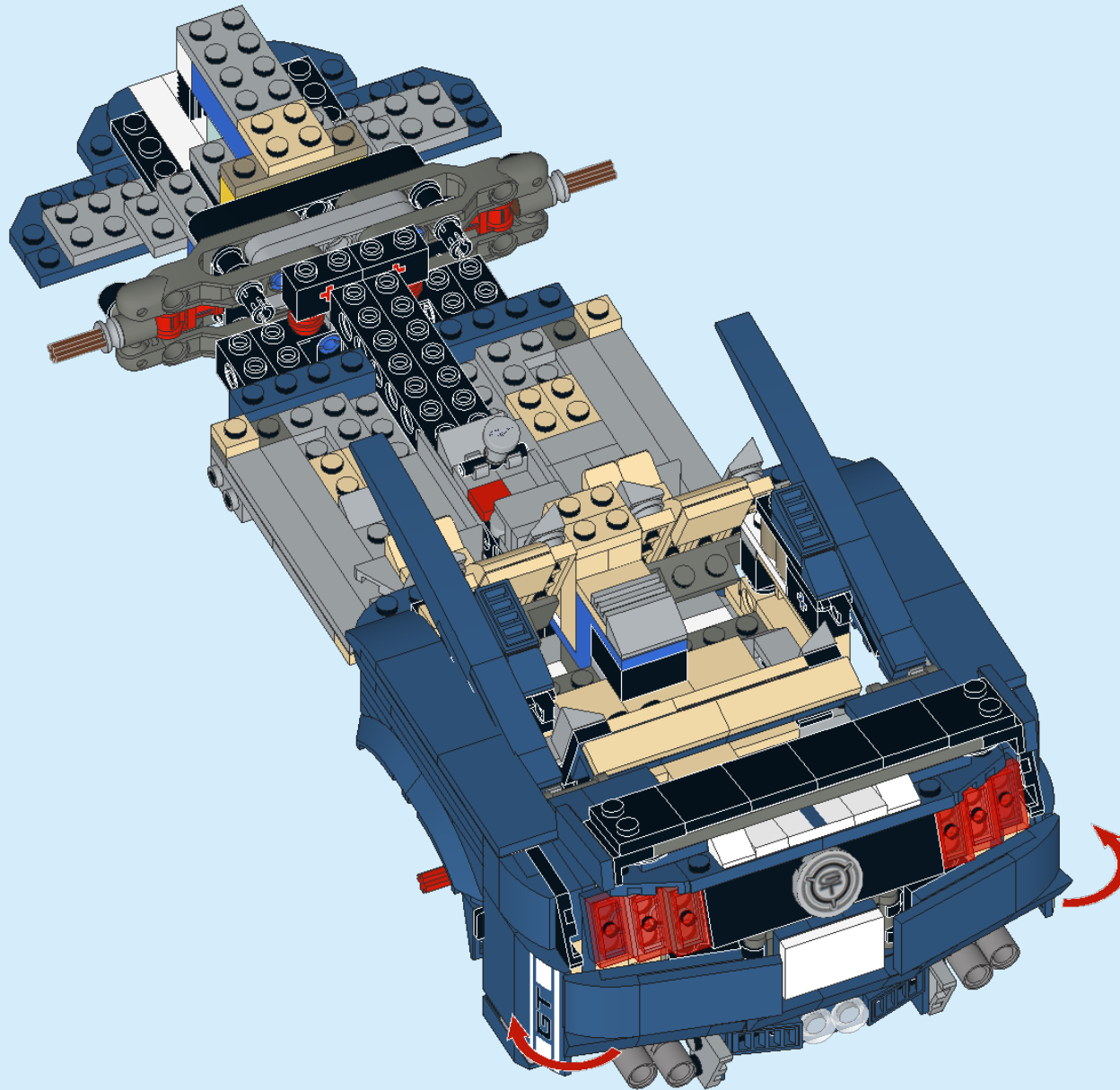

72

- 1x
- 2x
- 1x
- 1x
- 1x
- 1x
- 1x
- 1x
- 2x
- 1x
- 1x
- 1x

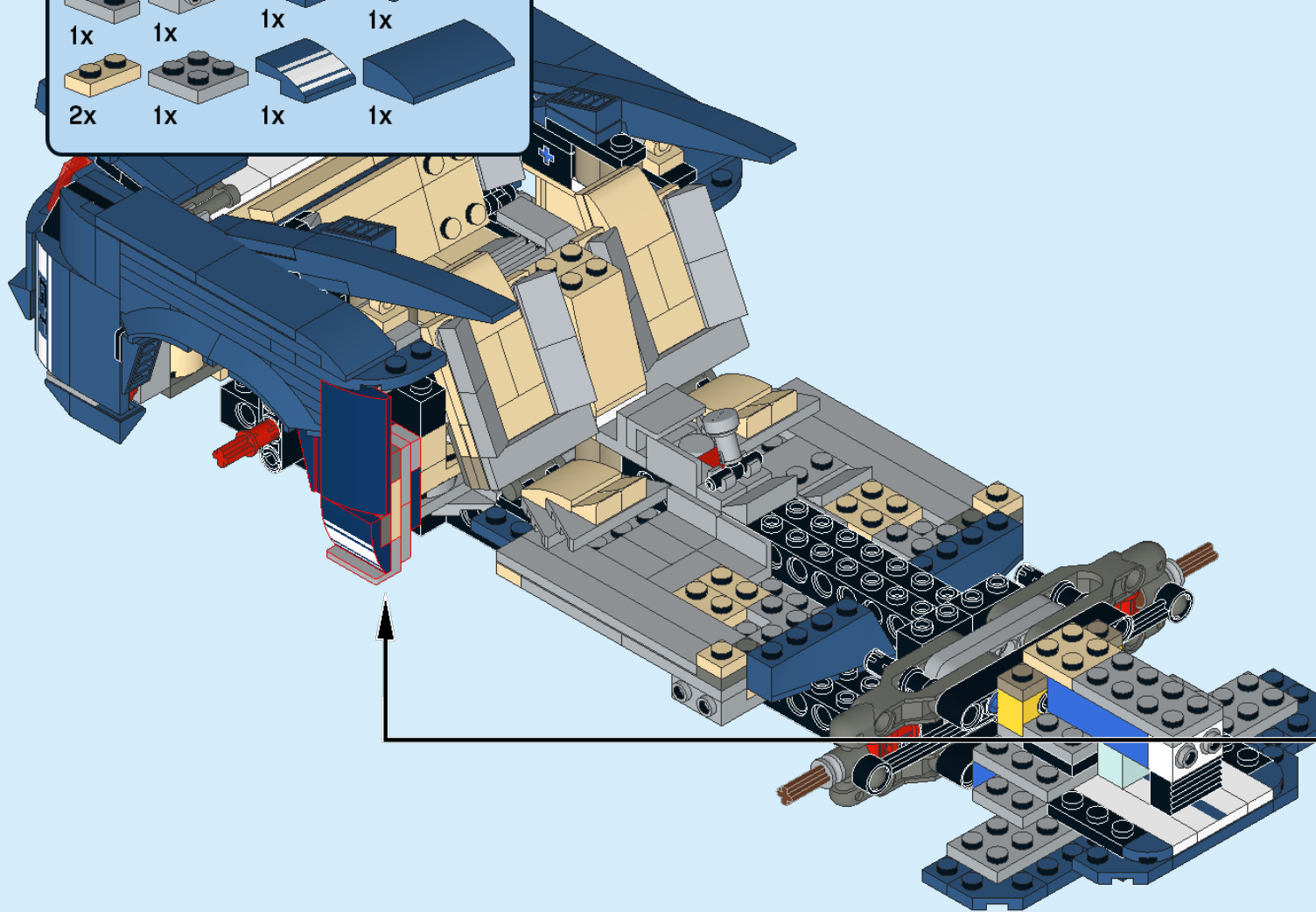

- 1
- 2
- 3
- 4
- 5

73

- 1x [Grey 1x4 Technic Brick with 2 holes]
- 1x [Blue 1x2 Technic Brick with 2 holes]
- 1x [Blue 1x2 Technic Brick with 2 holes]
- 1x [Grey 1x2 Technic Brick with 2 holes]
- 1x [Blue 1x2 Technic Brick with 2 holes]
- 1x [Blue 1x2 Technic Brick with 2 holes]
- 1x [Grey 1x2 Technic Brick with 2 holes]
- 2x [Grey 1x2 Technic Brick with 2 holes]
- 1x [Blue 1x2 Technic Brick with 2 holes]
- 1x [Yellow 1x2 Technic Brick with 2 holes]
- 1x [Grey 1x2 Technic Brick with 2 holes]
- 1x [Blue 1x2 Technic Brick with 2 holes]

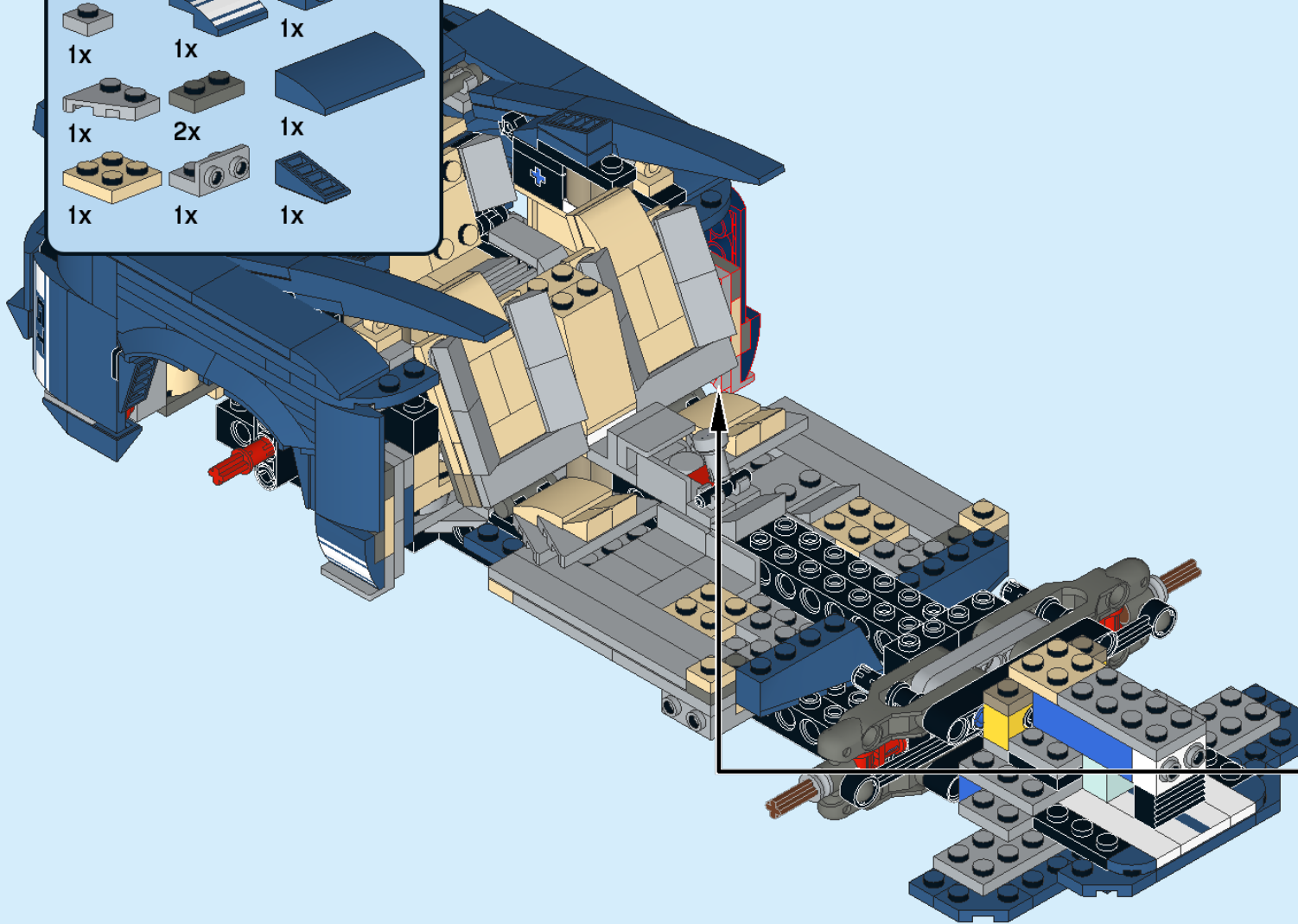

- 1 [Blue 1x2 Technic Brick with 2 holes]
- 2 [Blue 1x2 Technic Brick with 2 holes]
- 3 [Blue 1x2 Technic Brick with 2 holes]
- 4 [Blue 1x2 Technic Brick with 2 holes]
- 5 [Blue 1x2 Technic Brick with 2 holes]

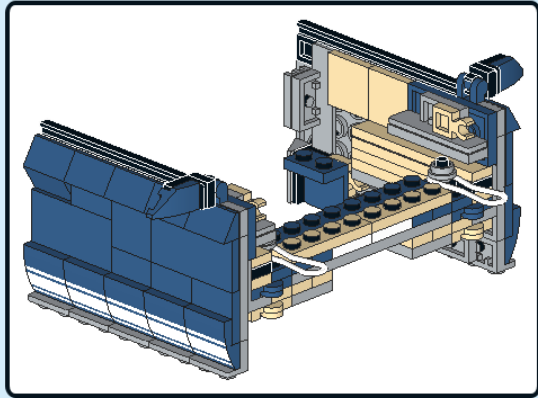

1

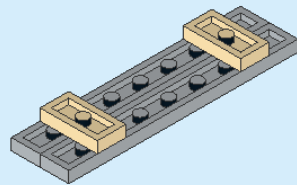
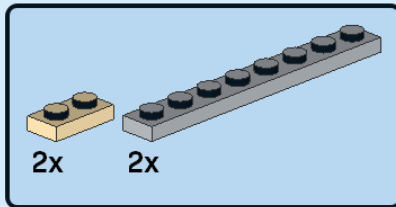

2

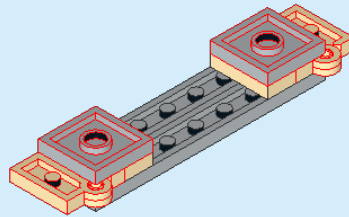
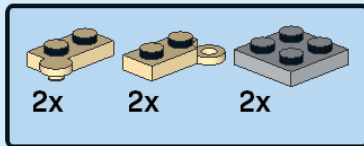

3

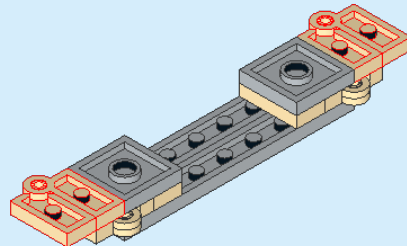
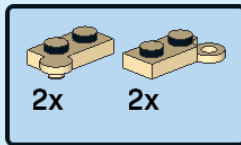

4

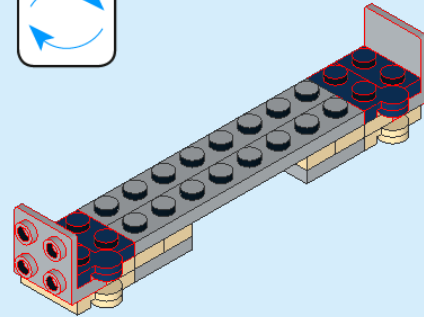
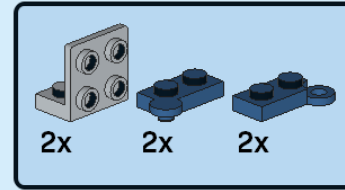

5

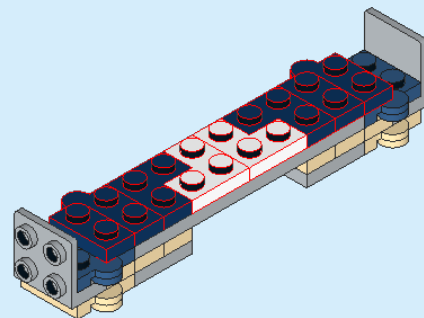
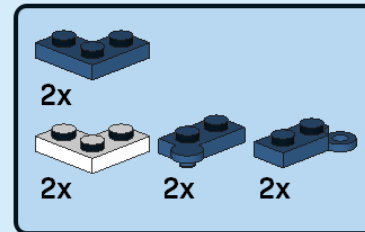

6

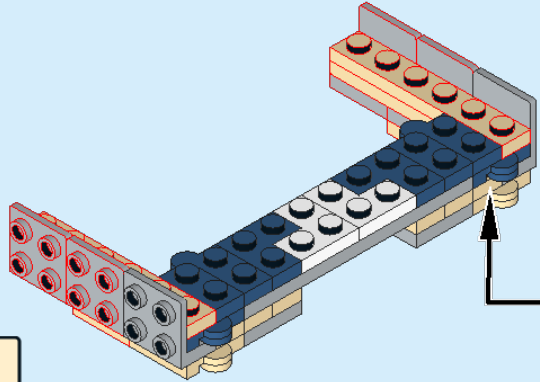
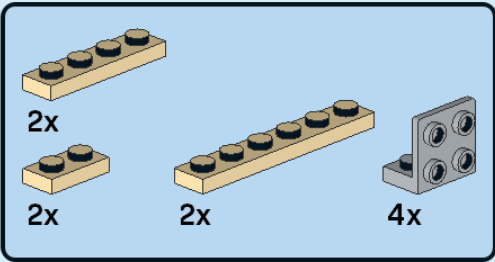

1

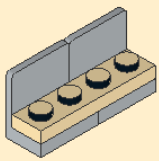

2

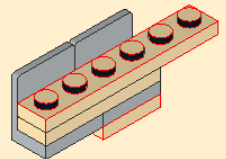

1

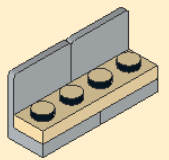

2

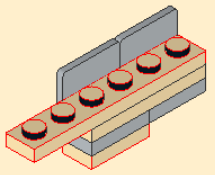

7

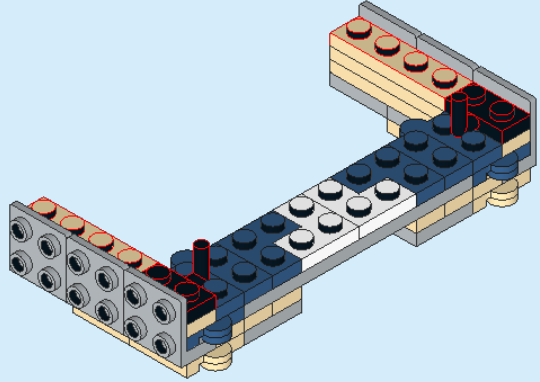
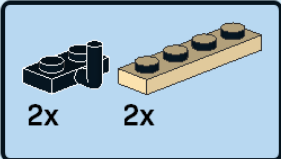

8

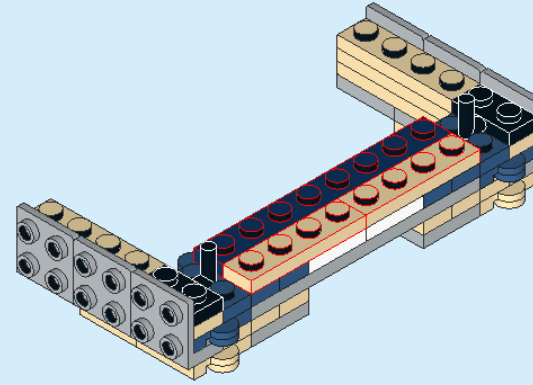
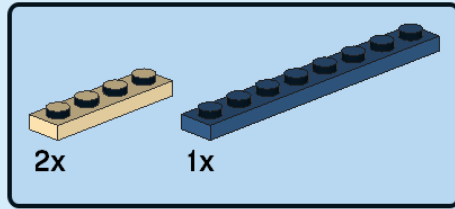

9

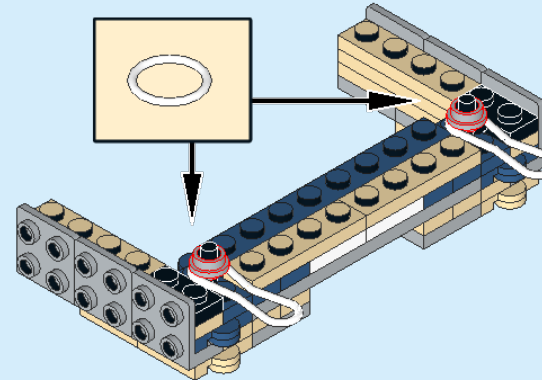
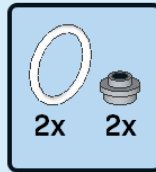

10

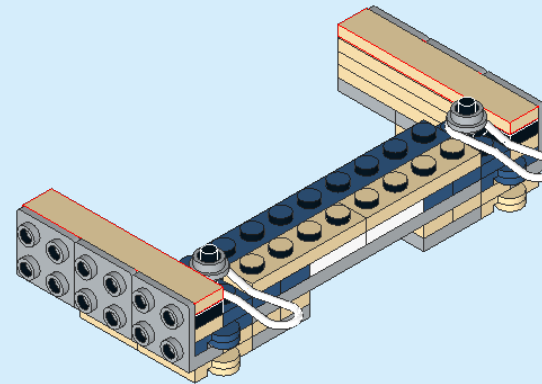
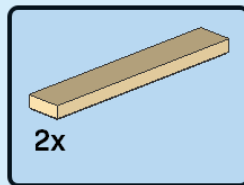

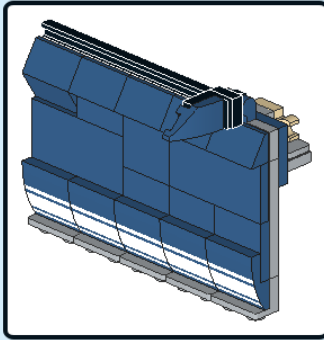

1

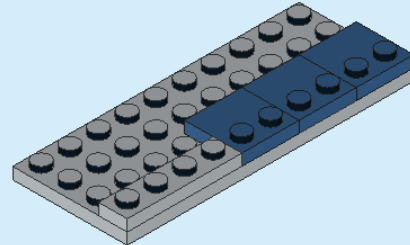
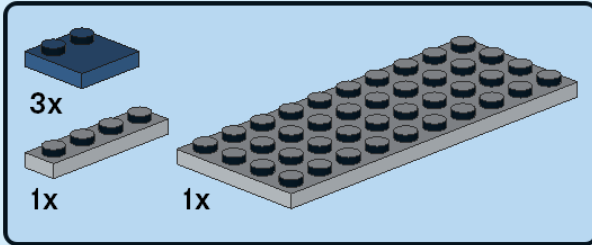

2

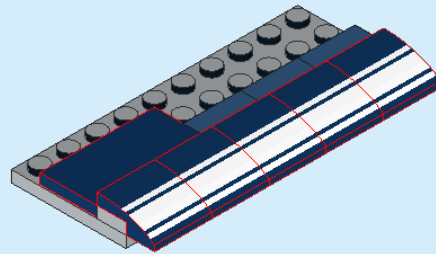
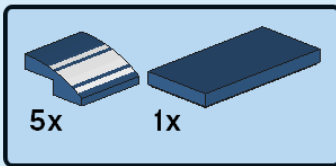

3

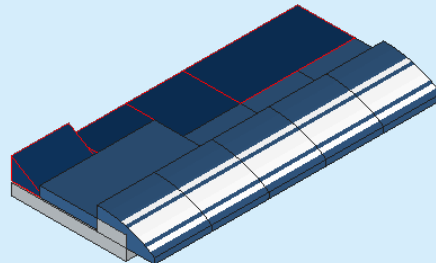
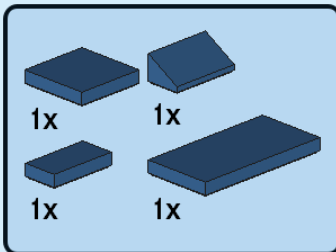

4

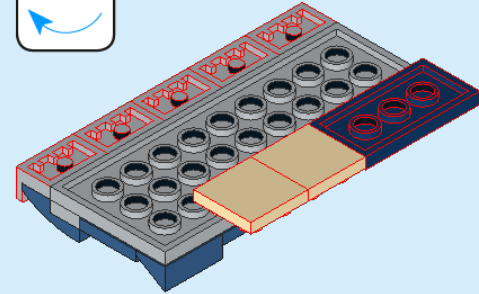
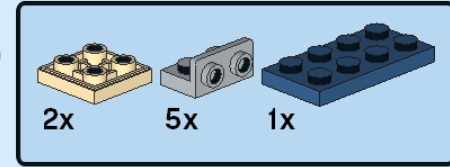

5

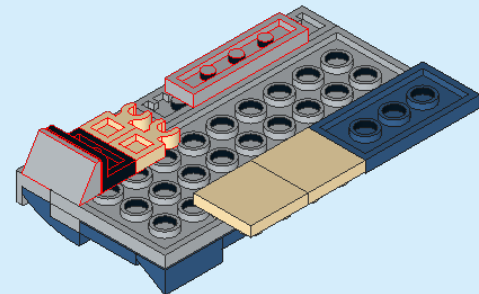
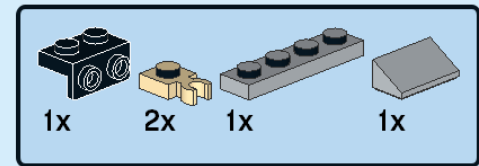

6

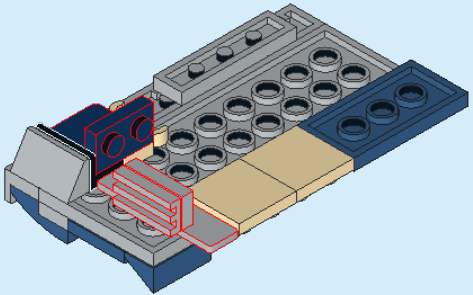
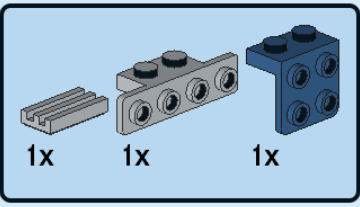

7

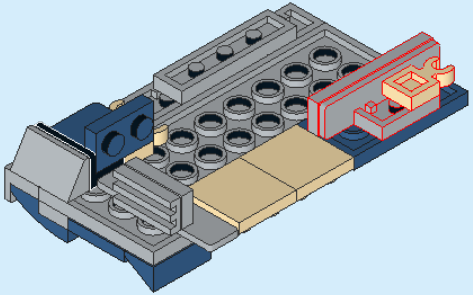
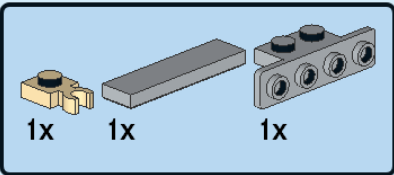

8

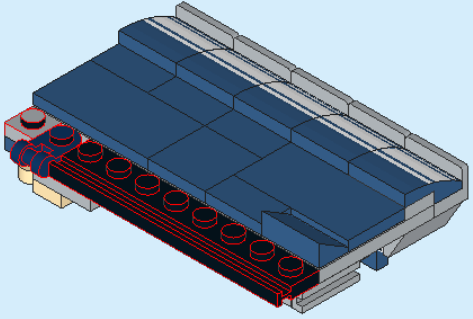
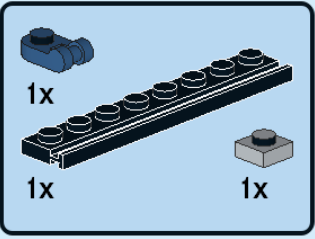

9

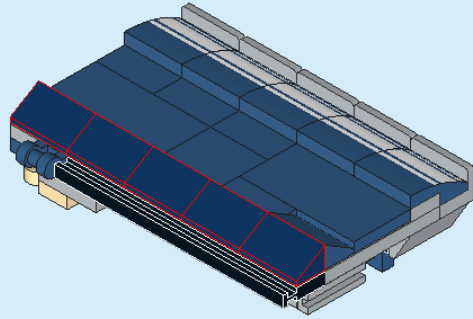
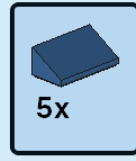

10

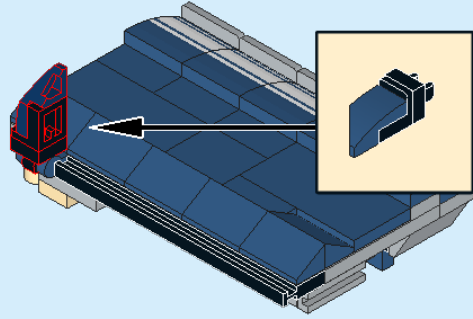
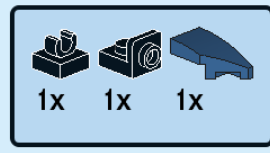

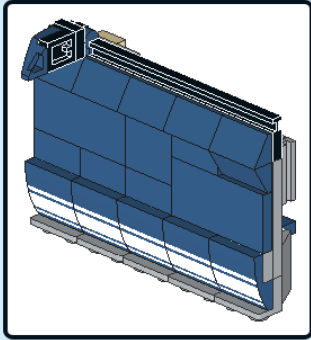

1

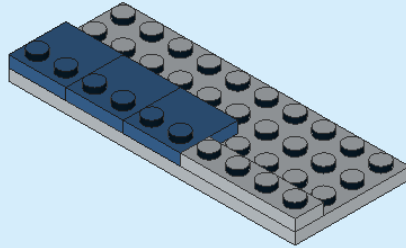
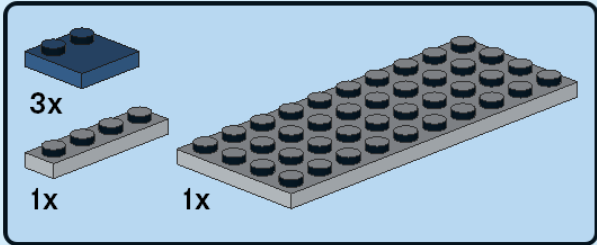

2

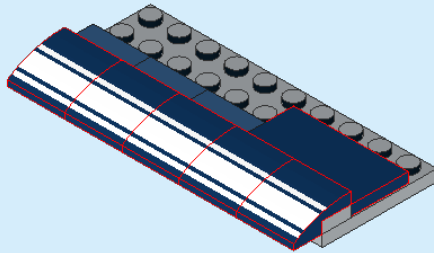
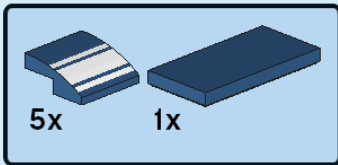

3

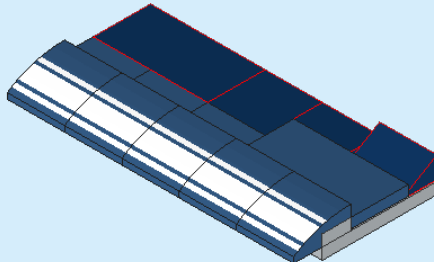
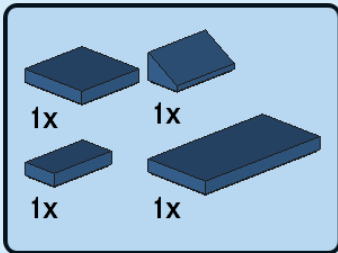

4

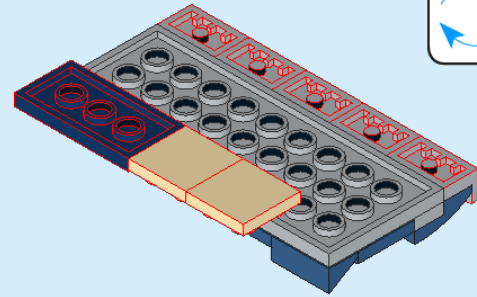
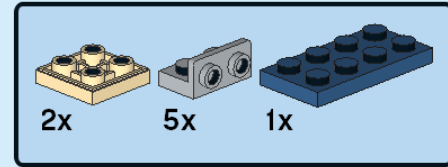

5

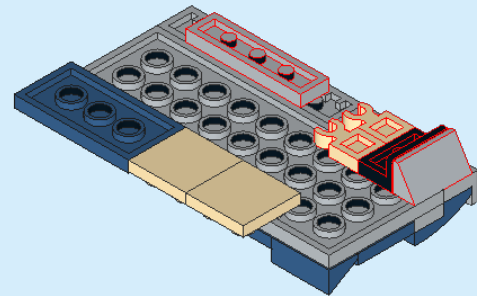
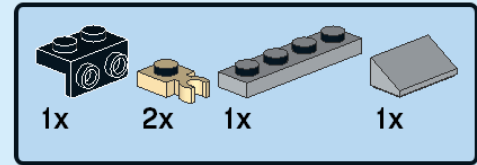

6

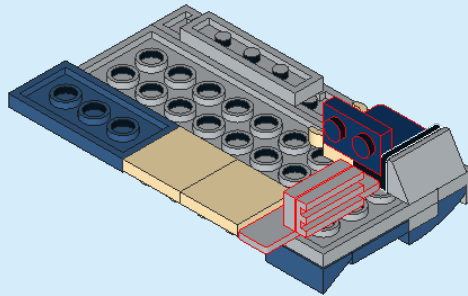
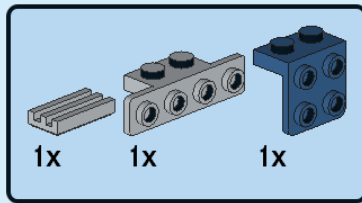

7

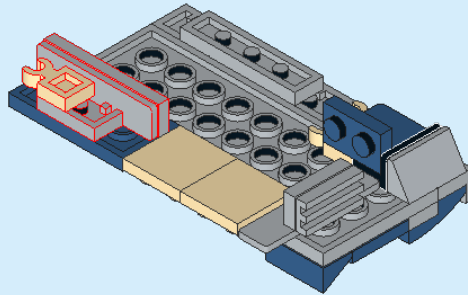
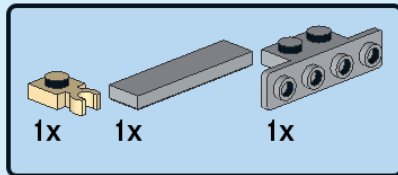

8

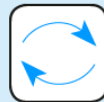
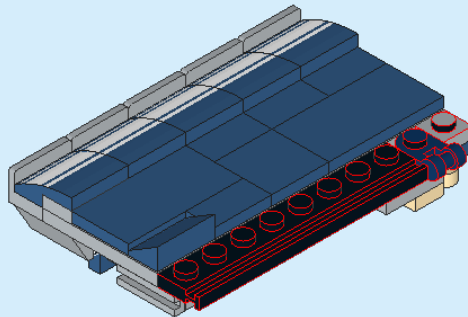
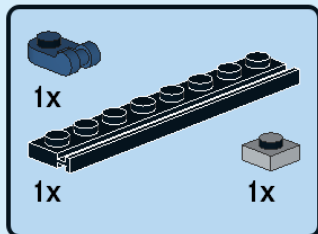

9

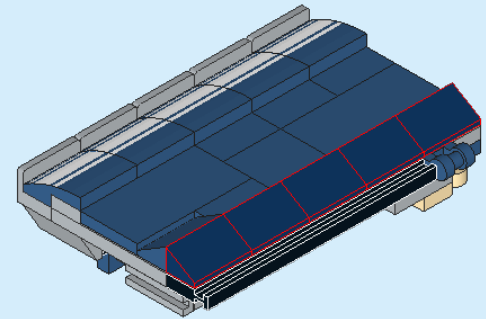
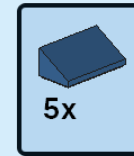

10

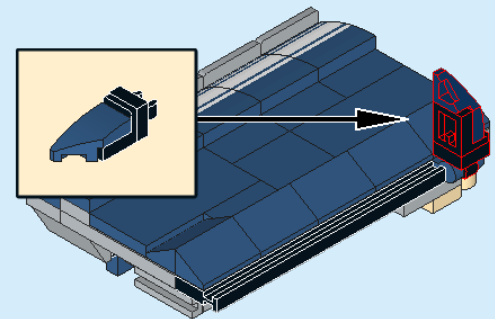
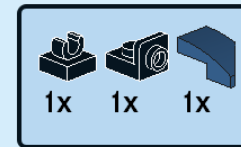

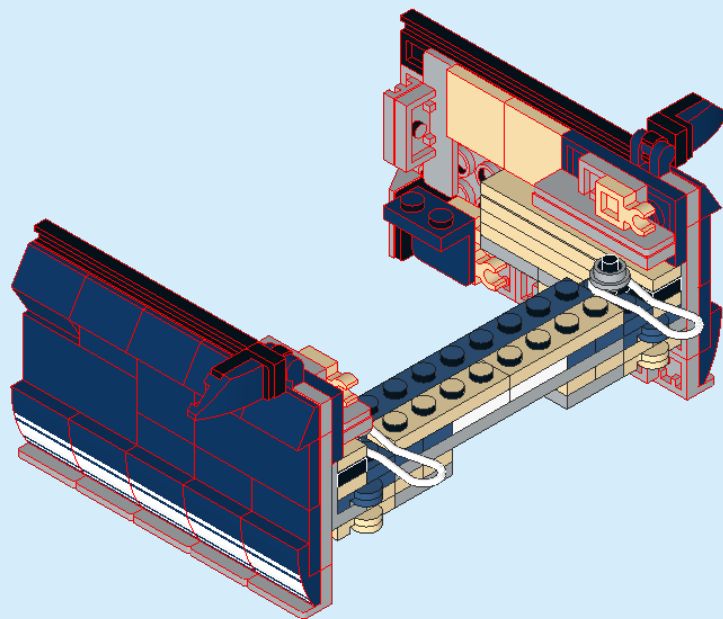

74

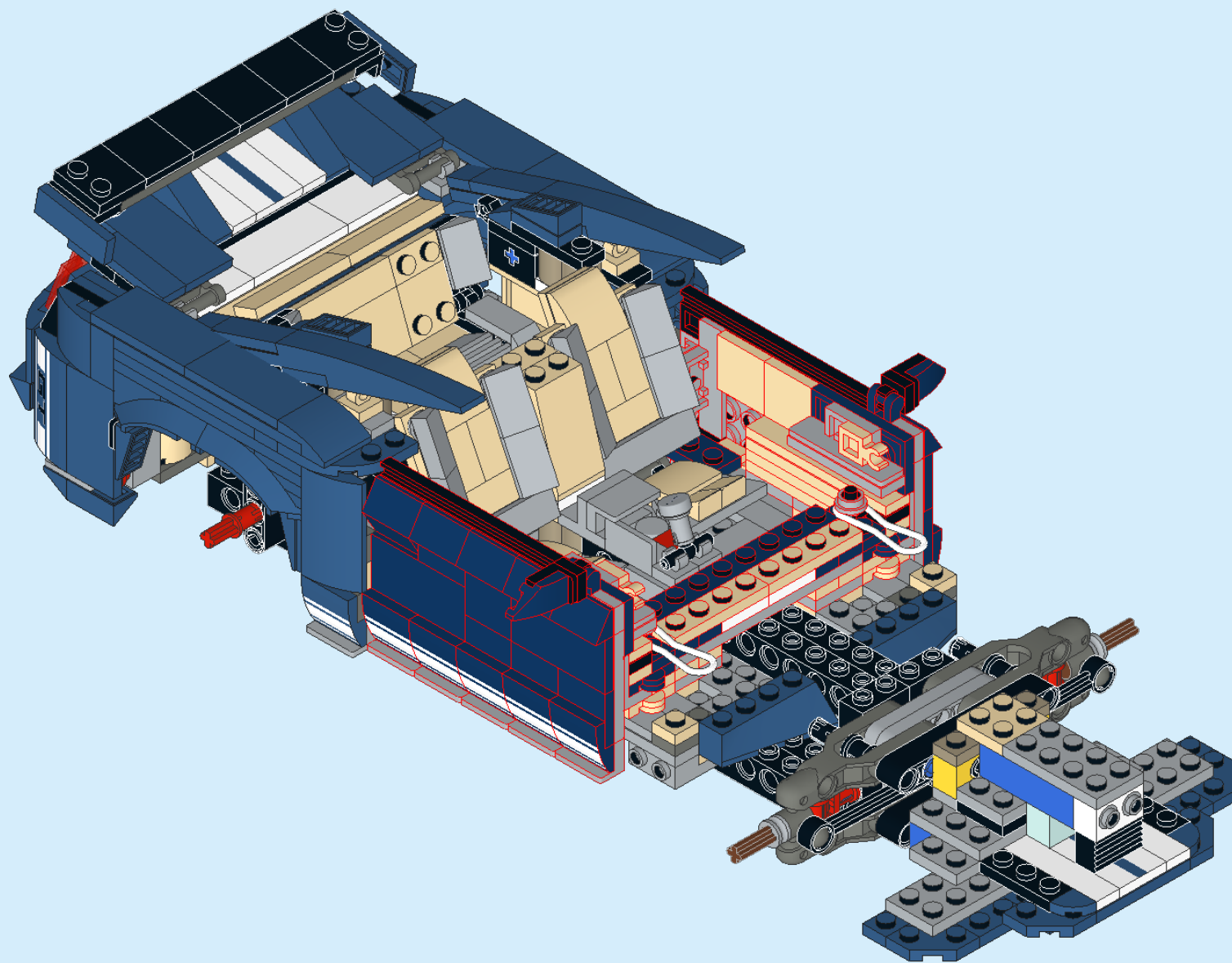

75

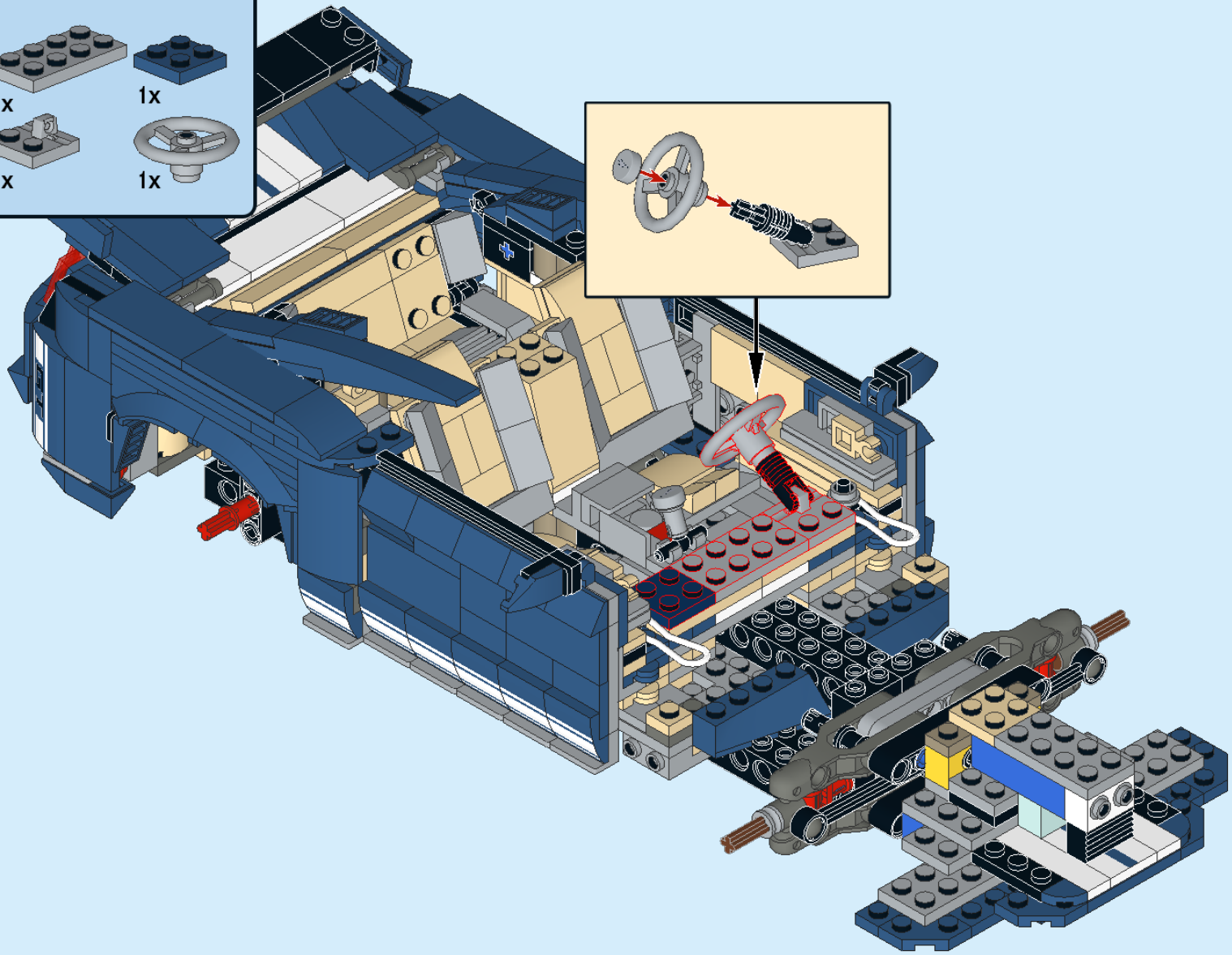
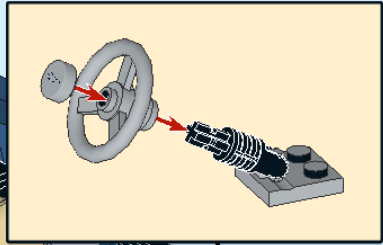
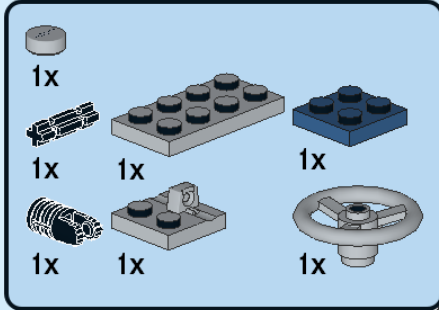



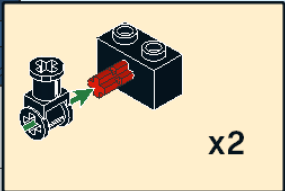
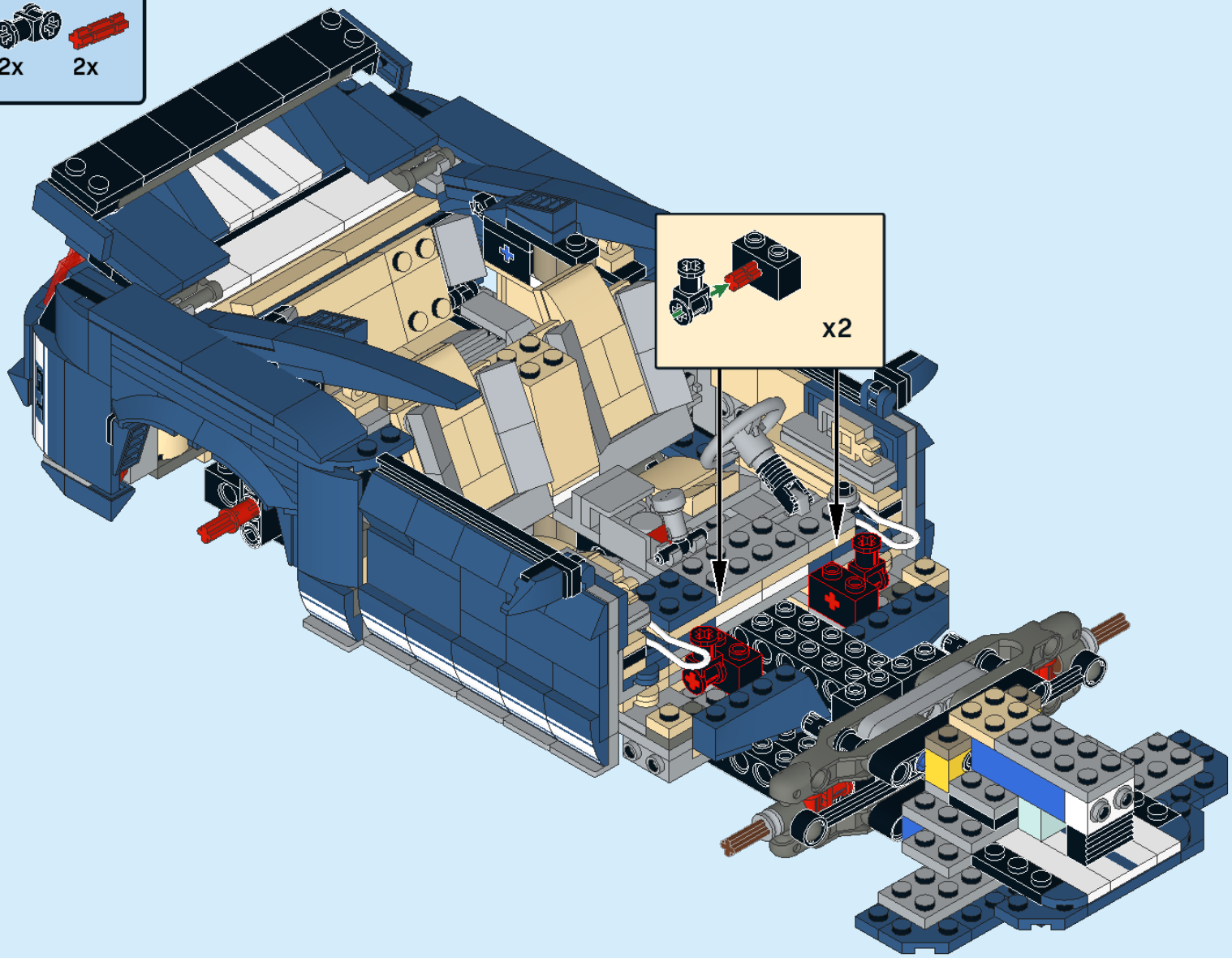
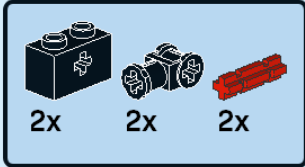

76

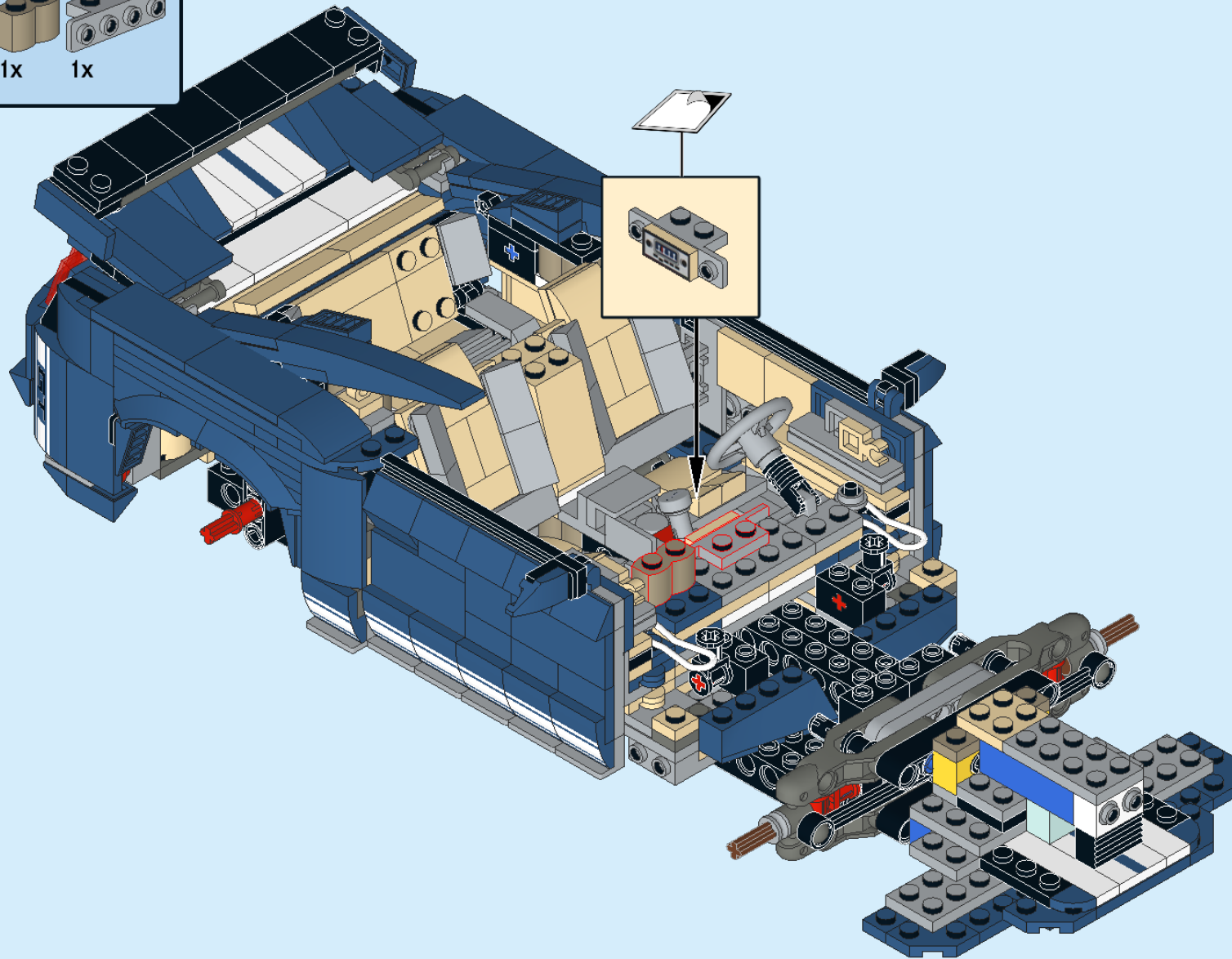
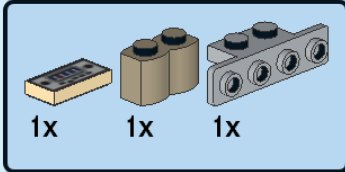

77



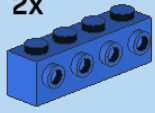

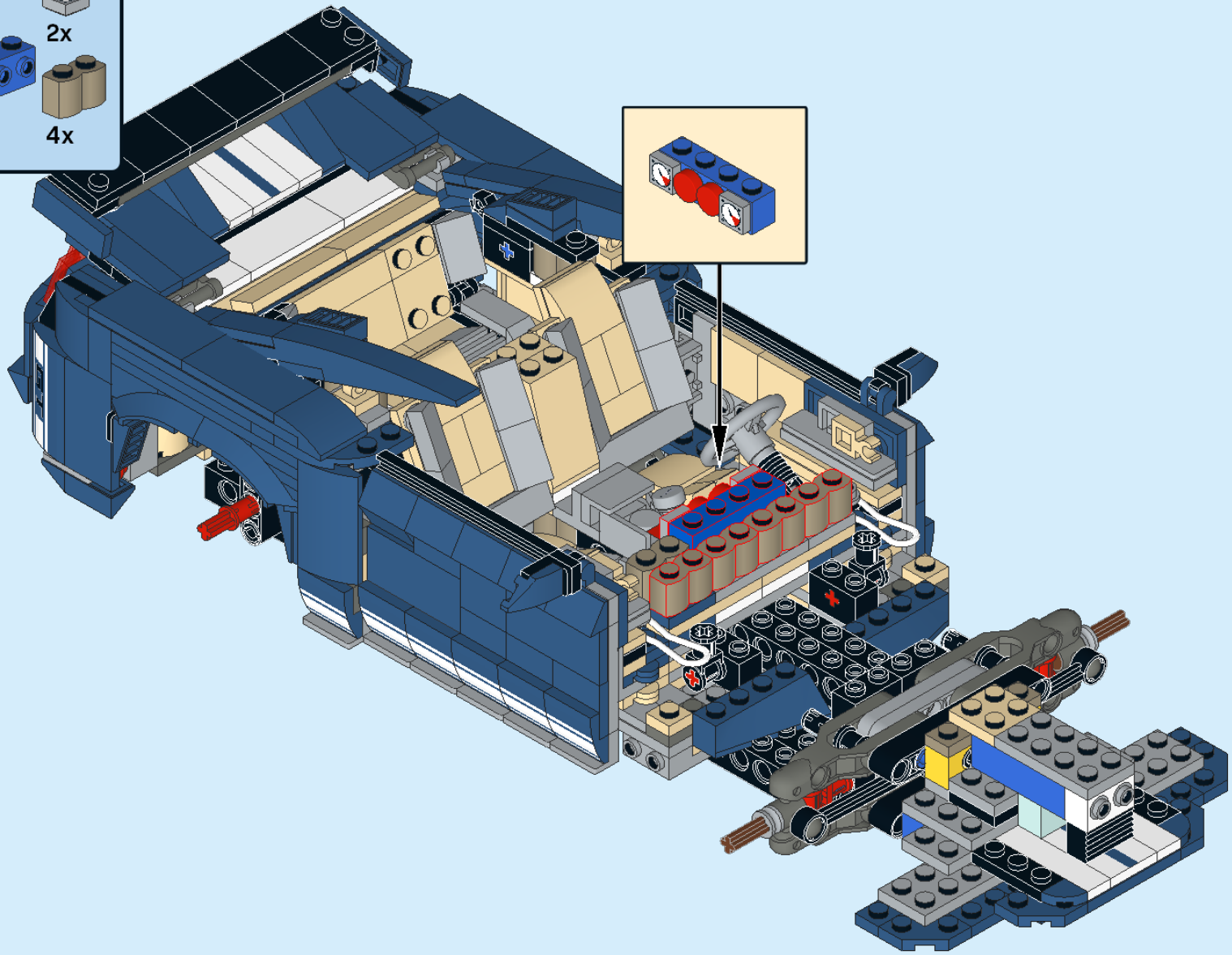

78

- 2x 
- 2x 
- 1x 
- 4x 

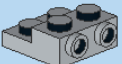

79

			
1x	2x	1x	1x

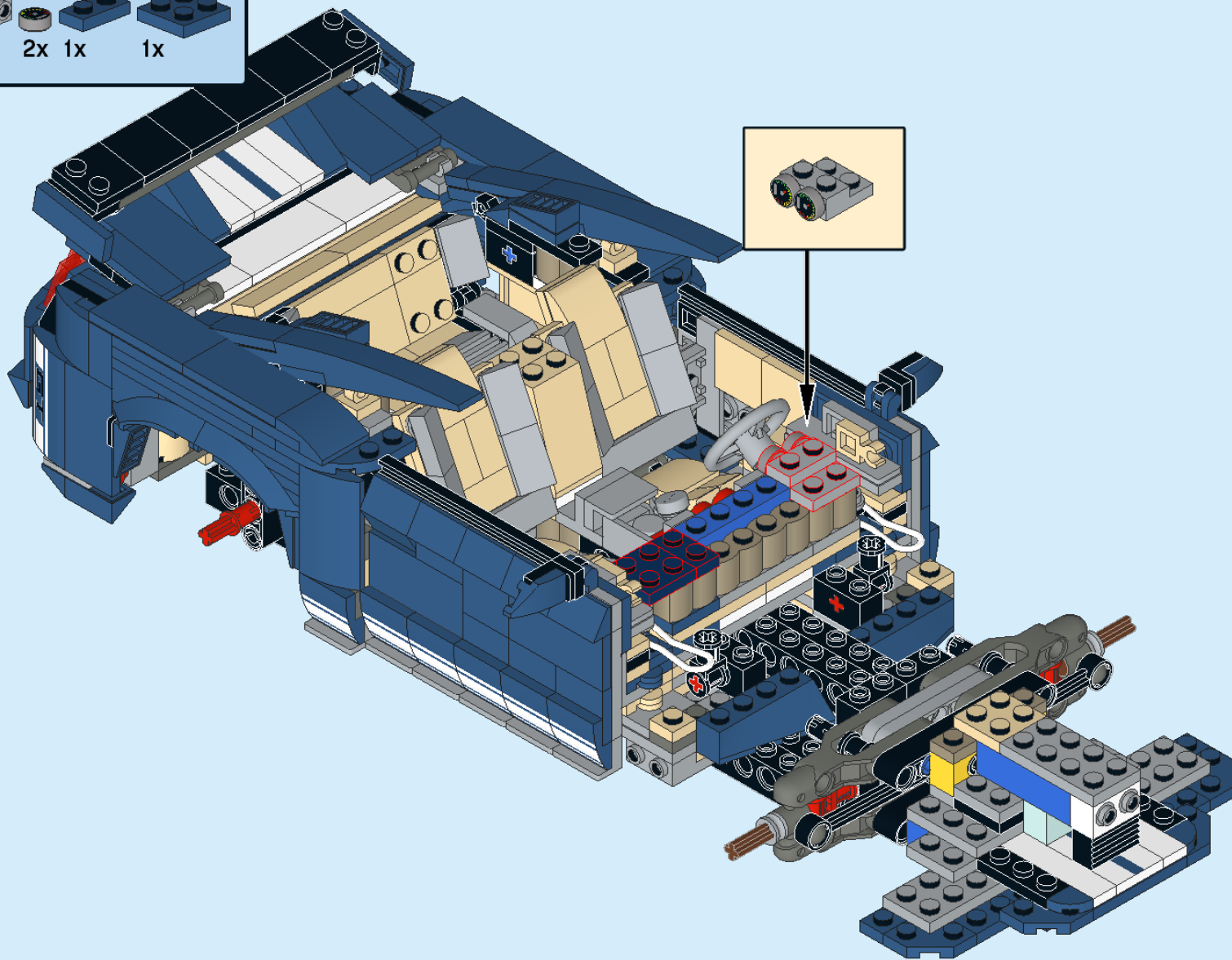

80

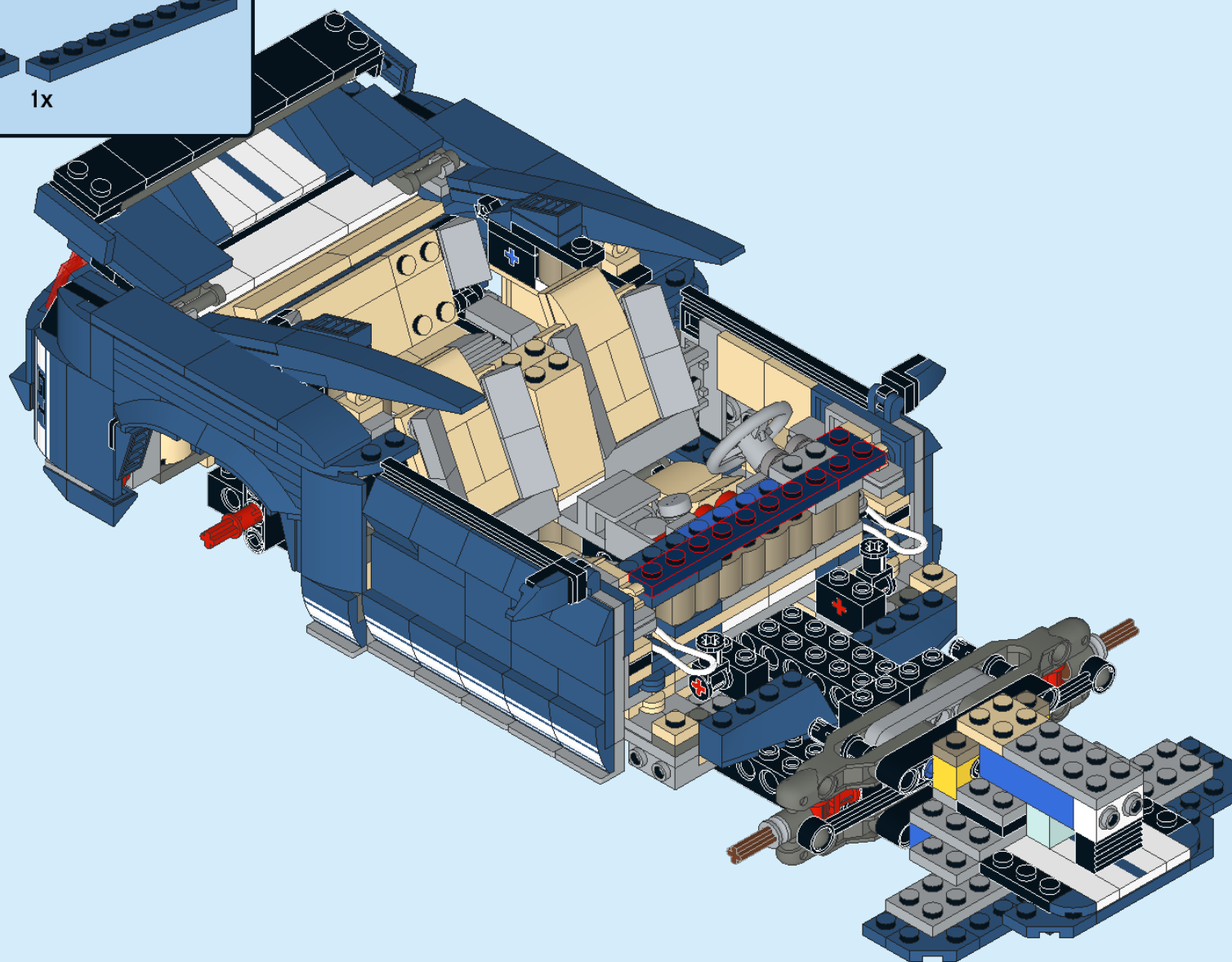
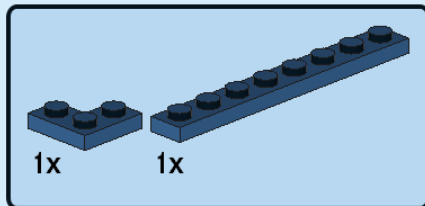

81

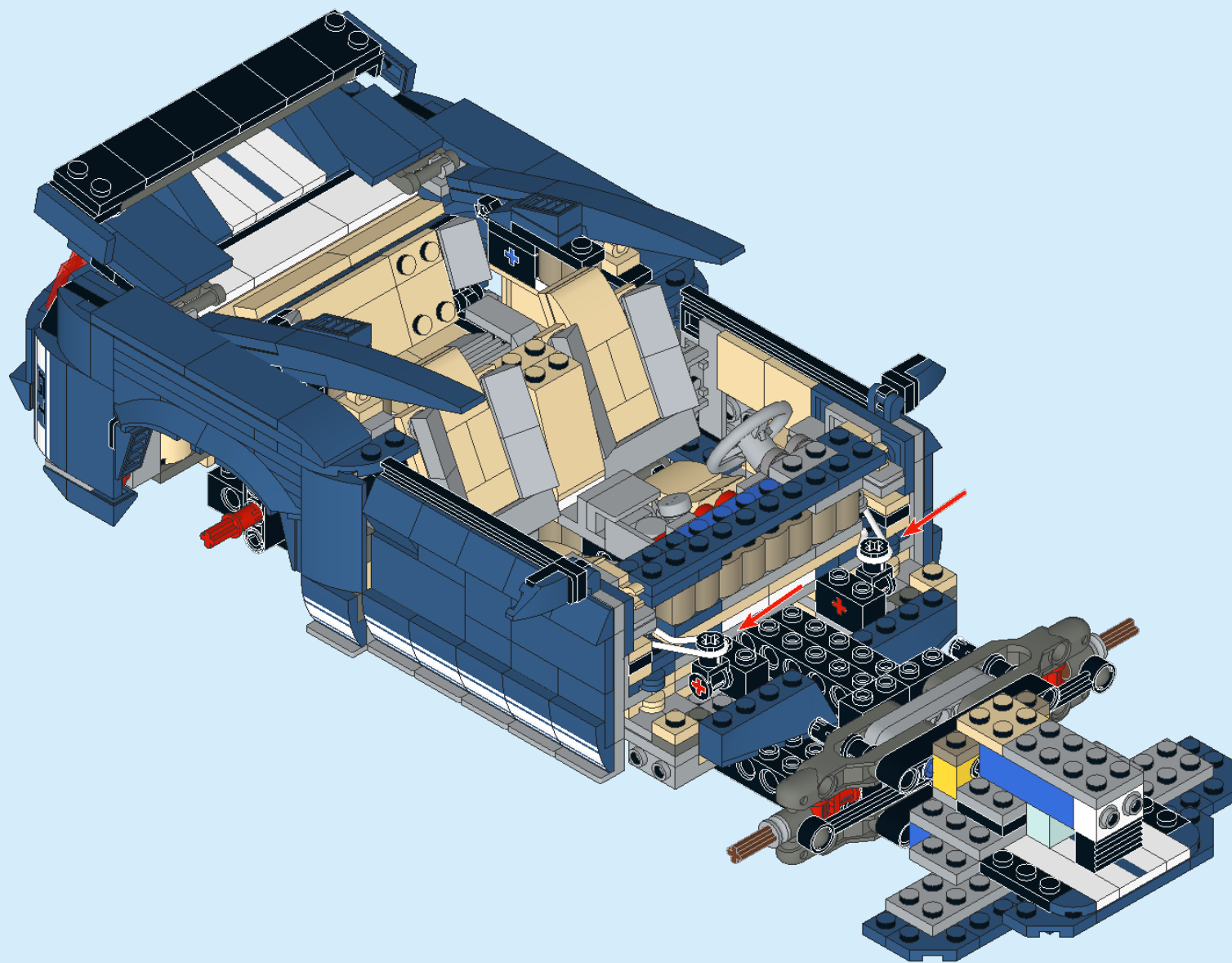

82

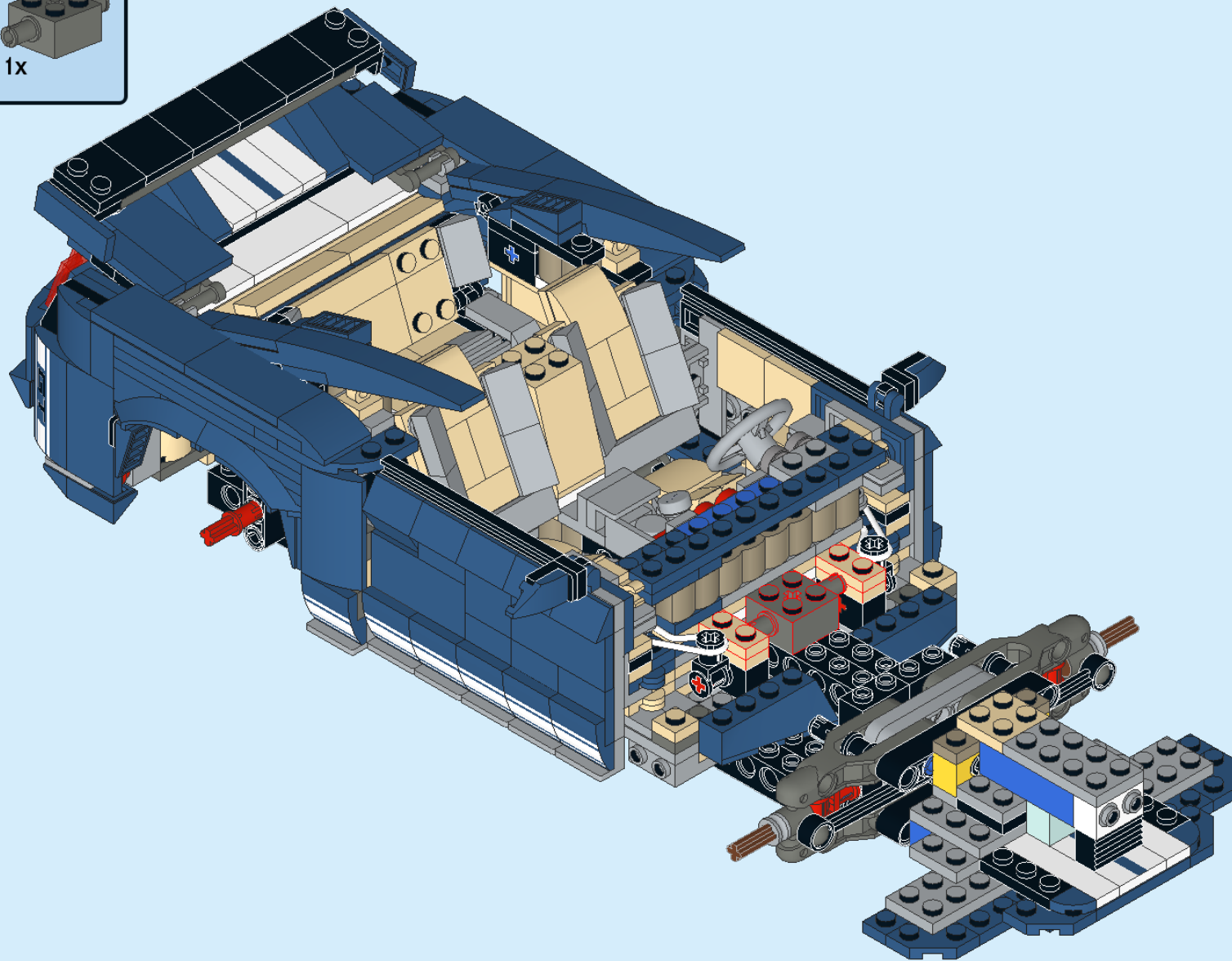
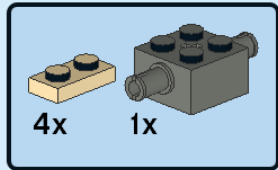

83

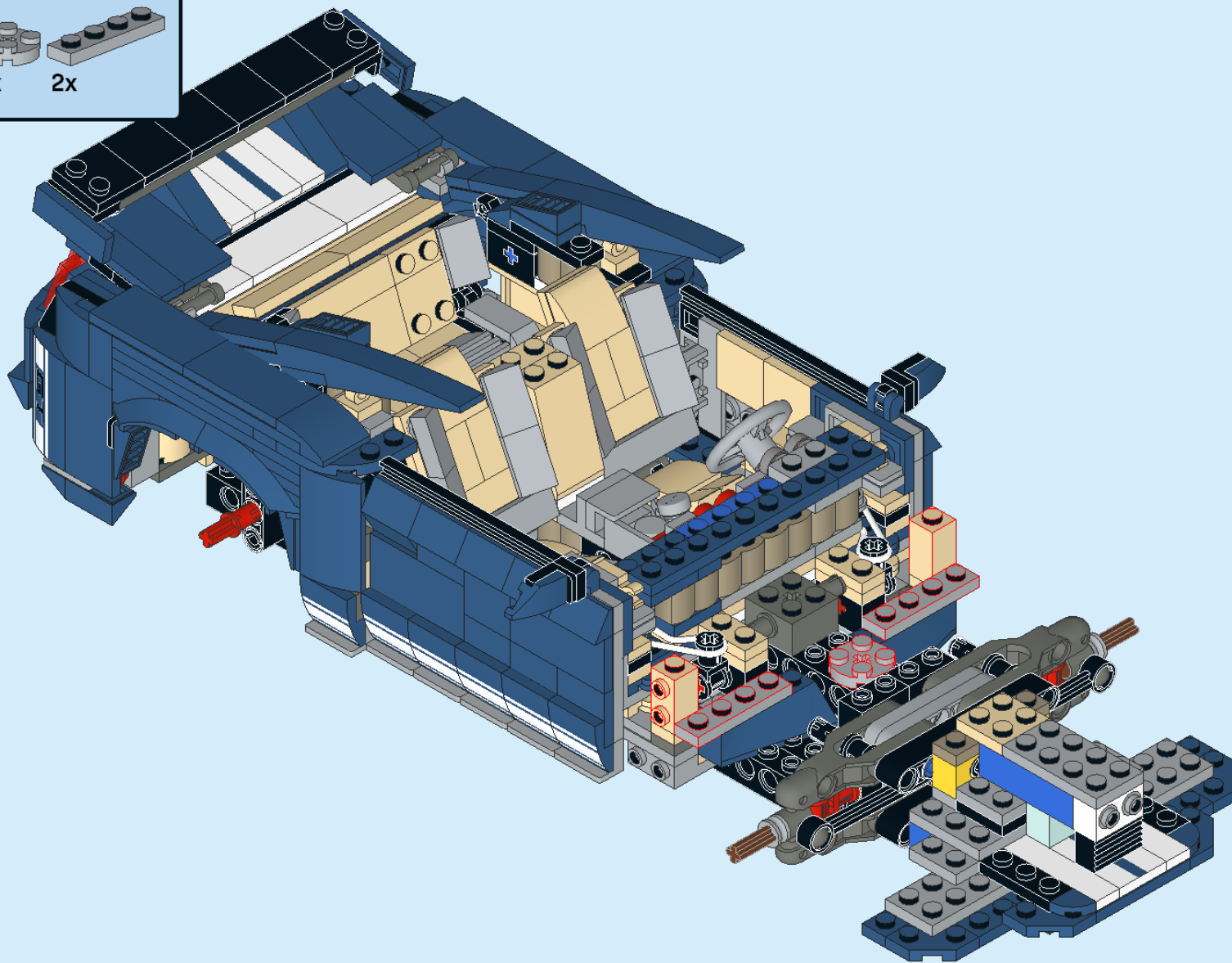
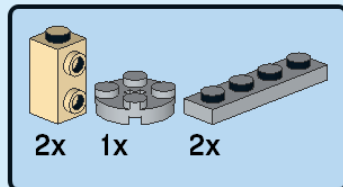

84

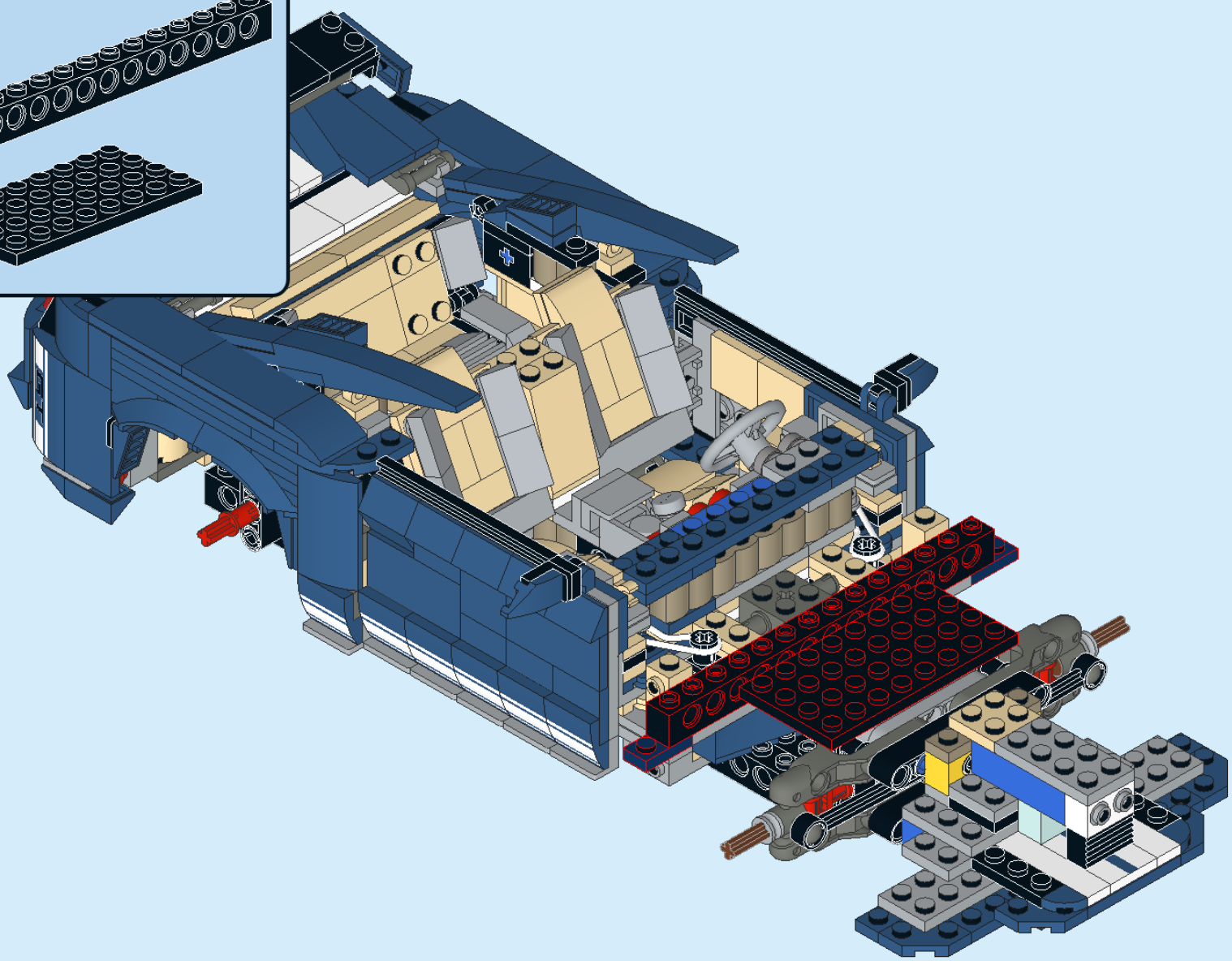
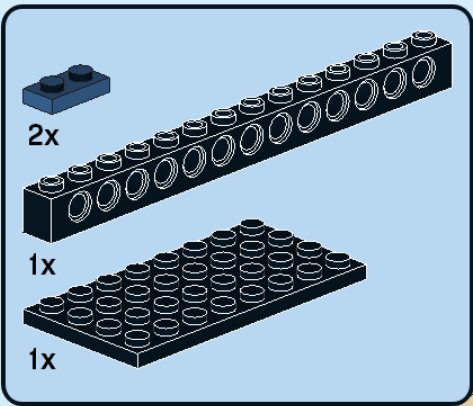

85

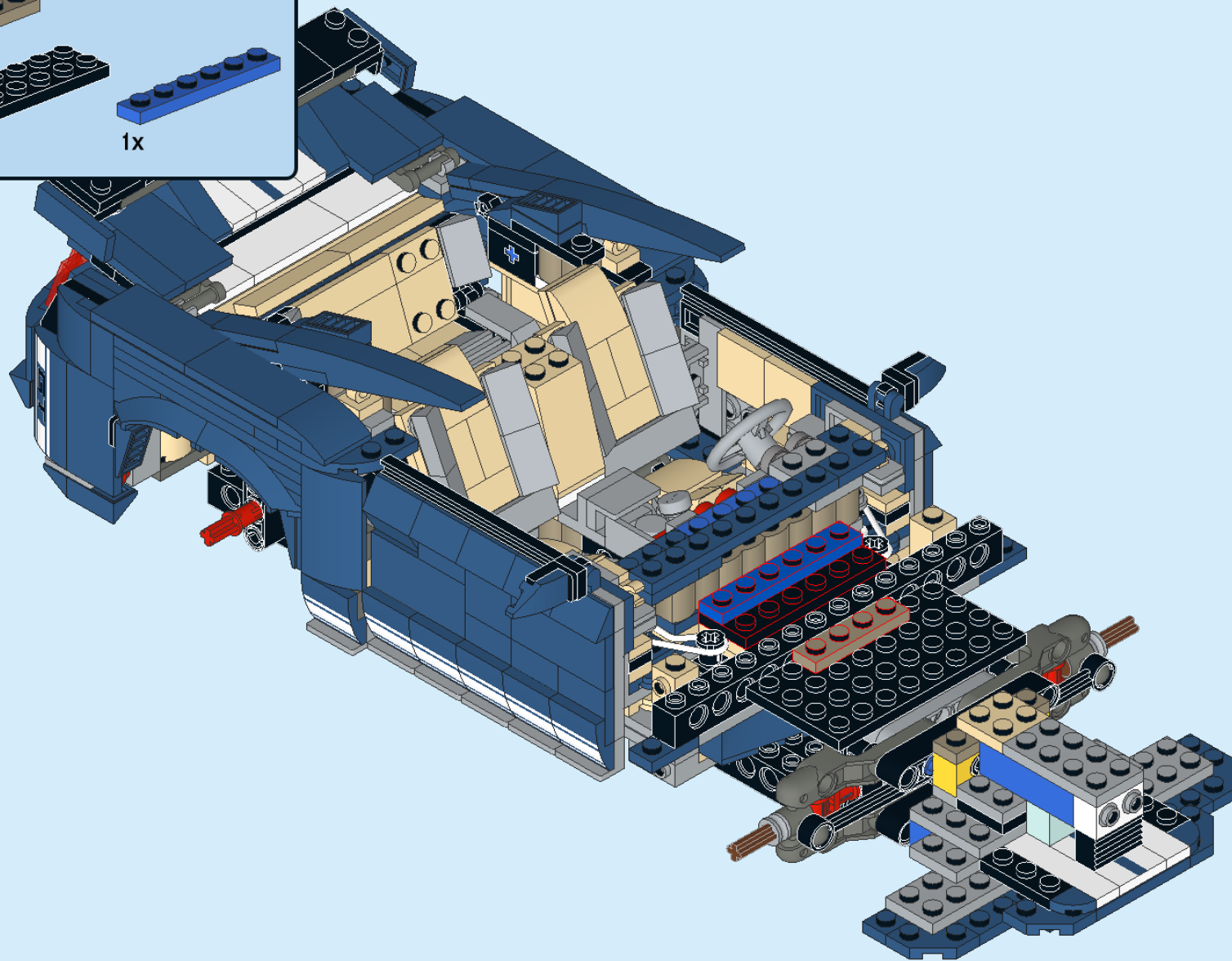
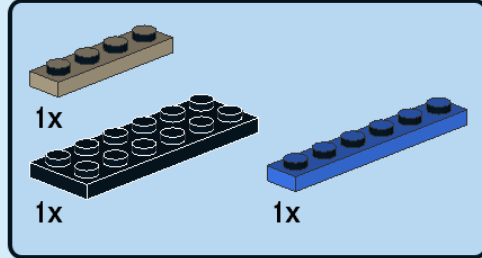

87

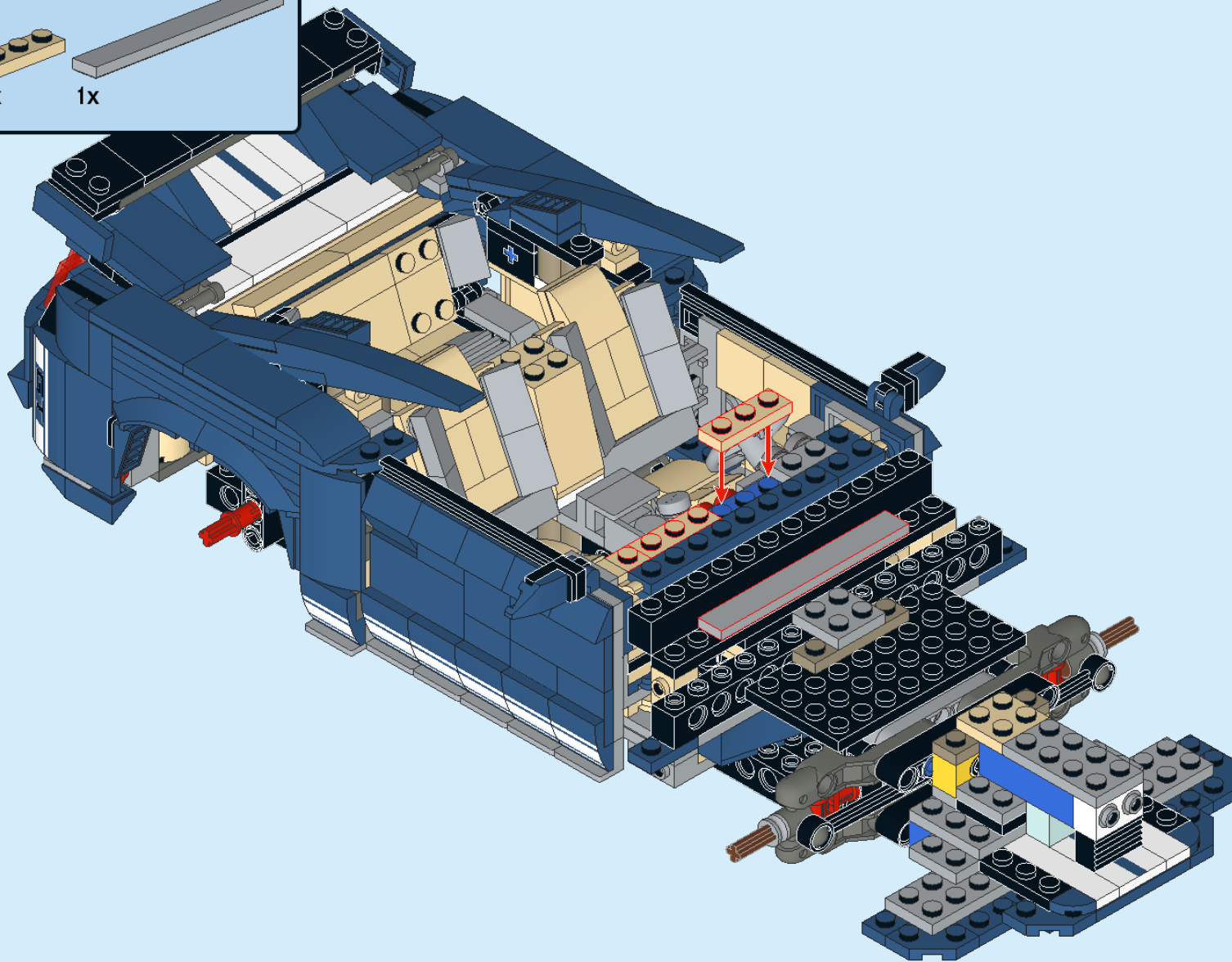
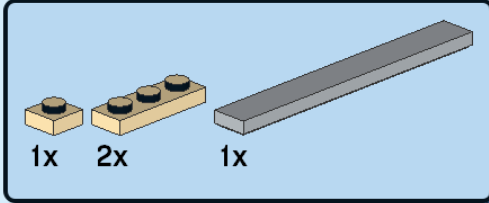

88

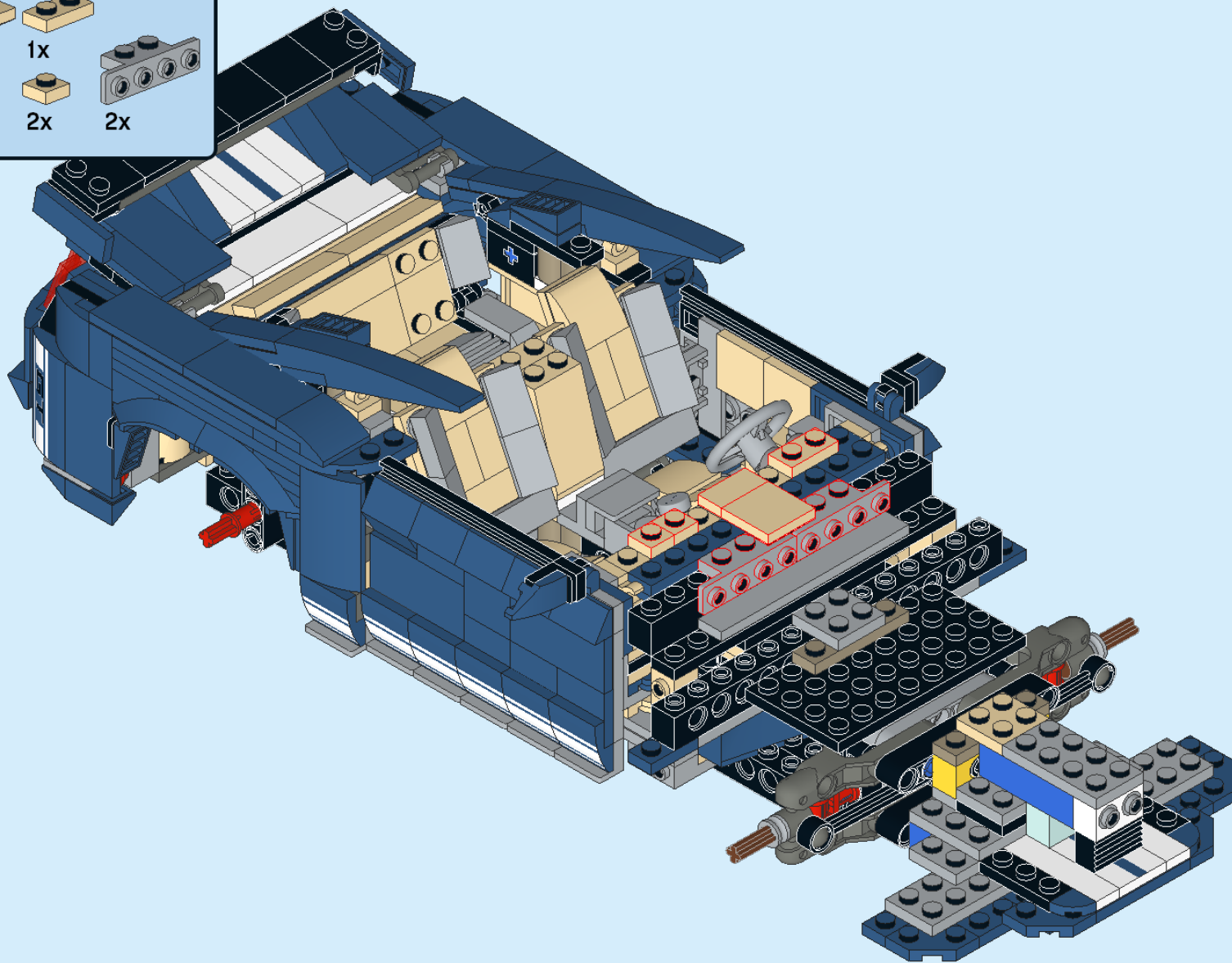
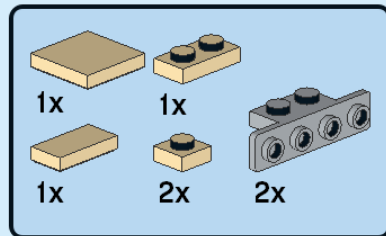

89

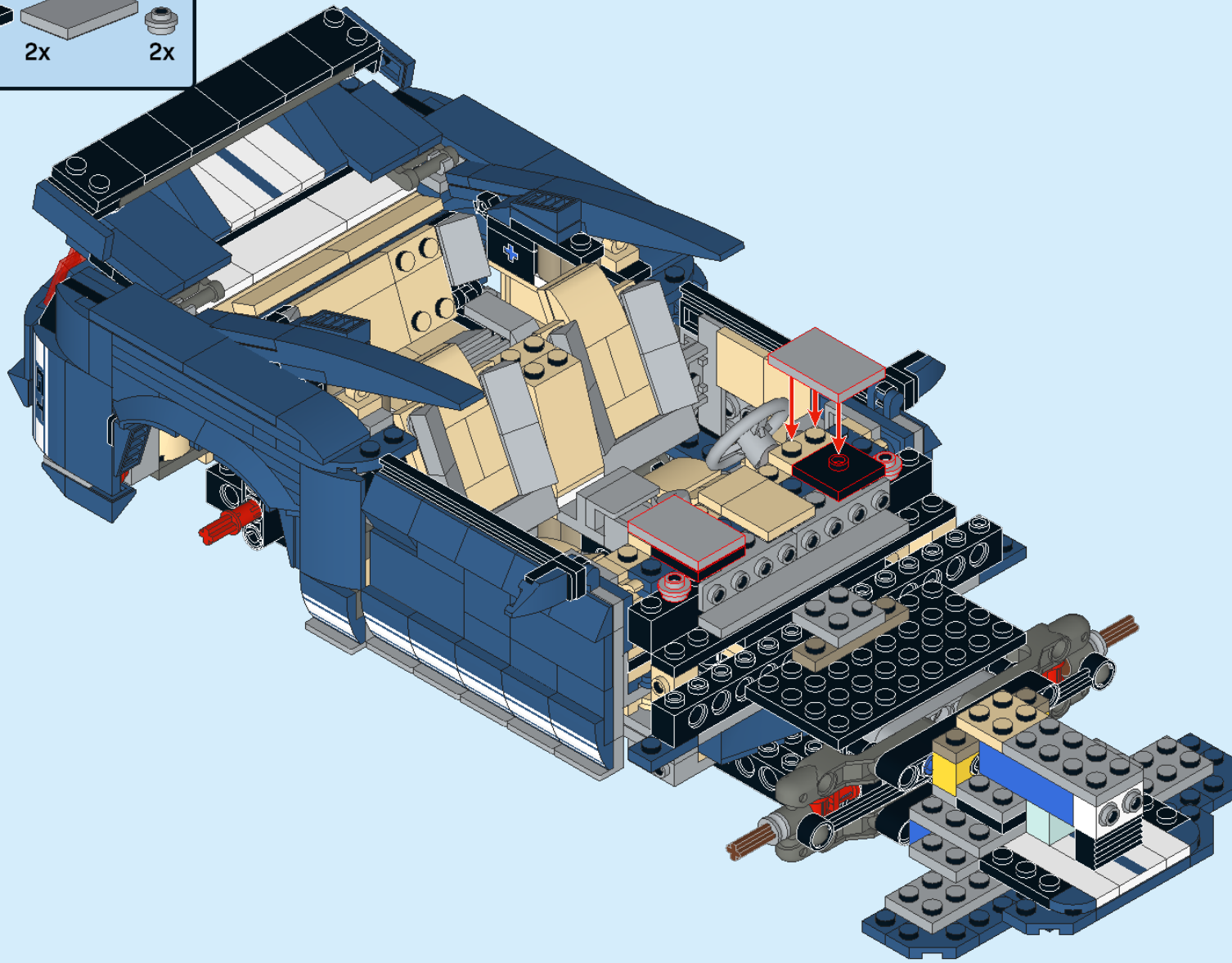
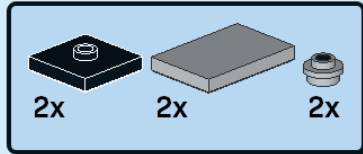

90

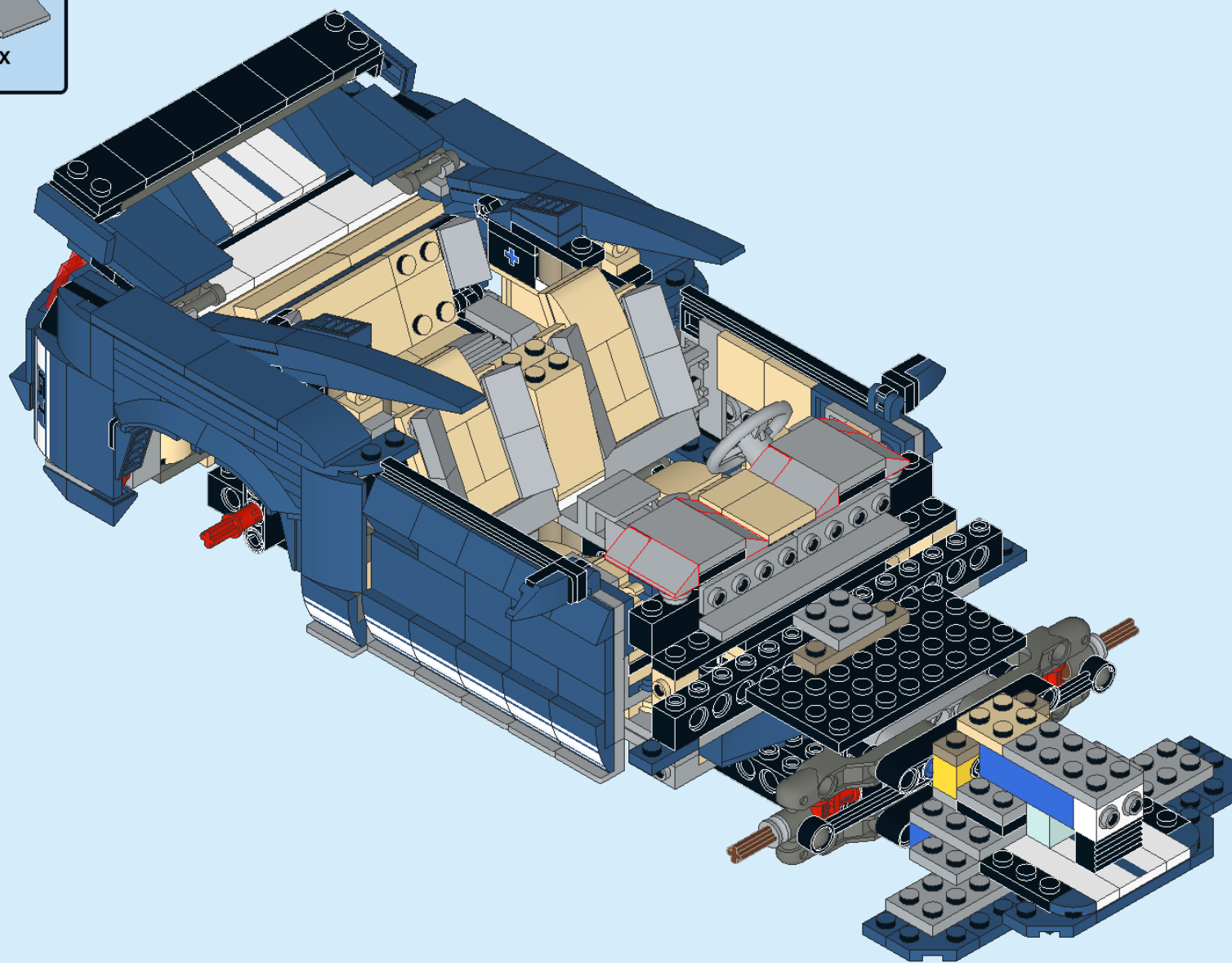
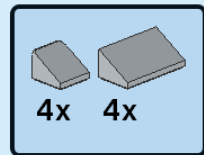

91

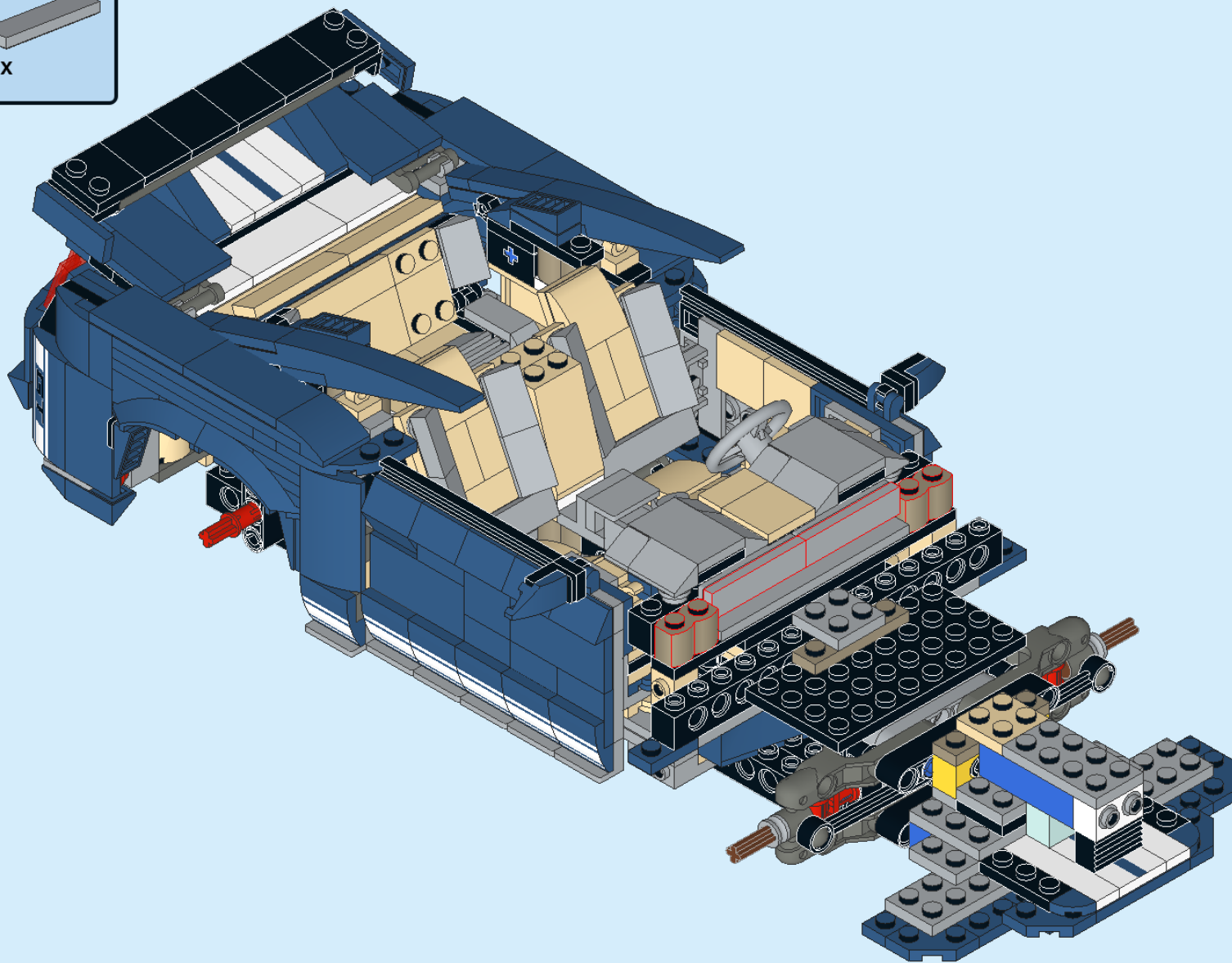
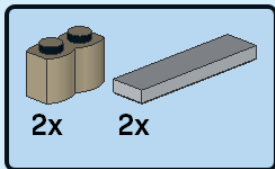

92

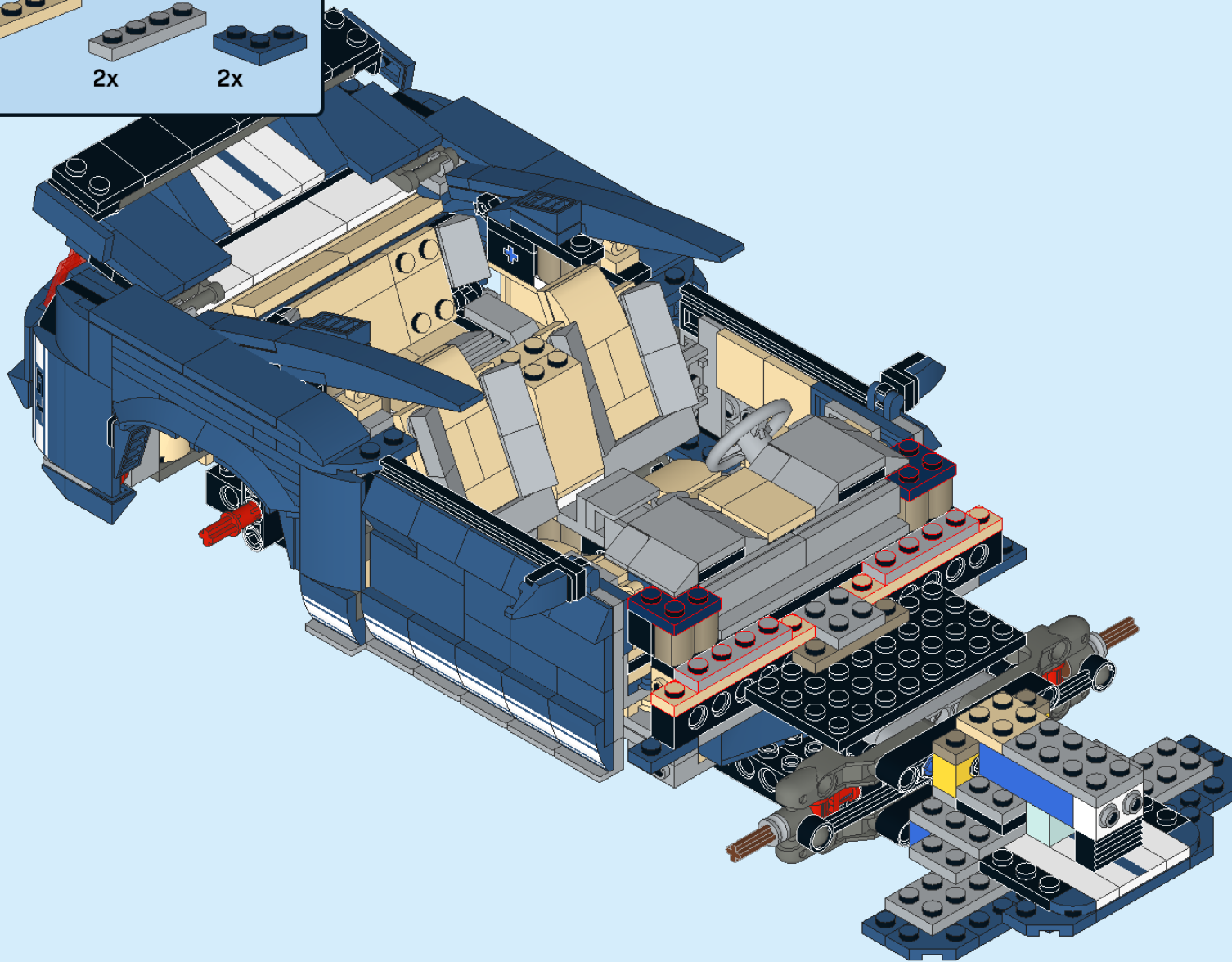
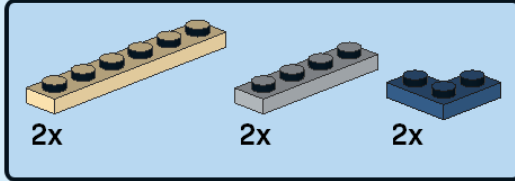

93

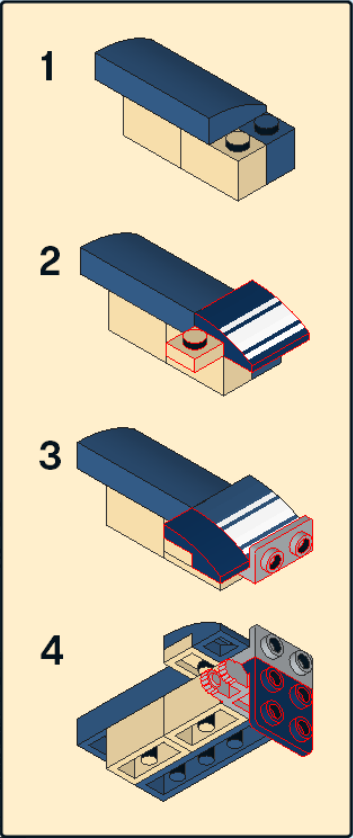
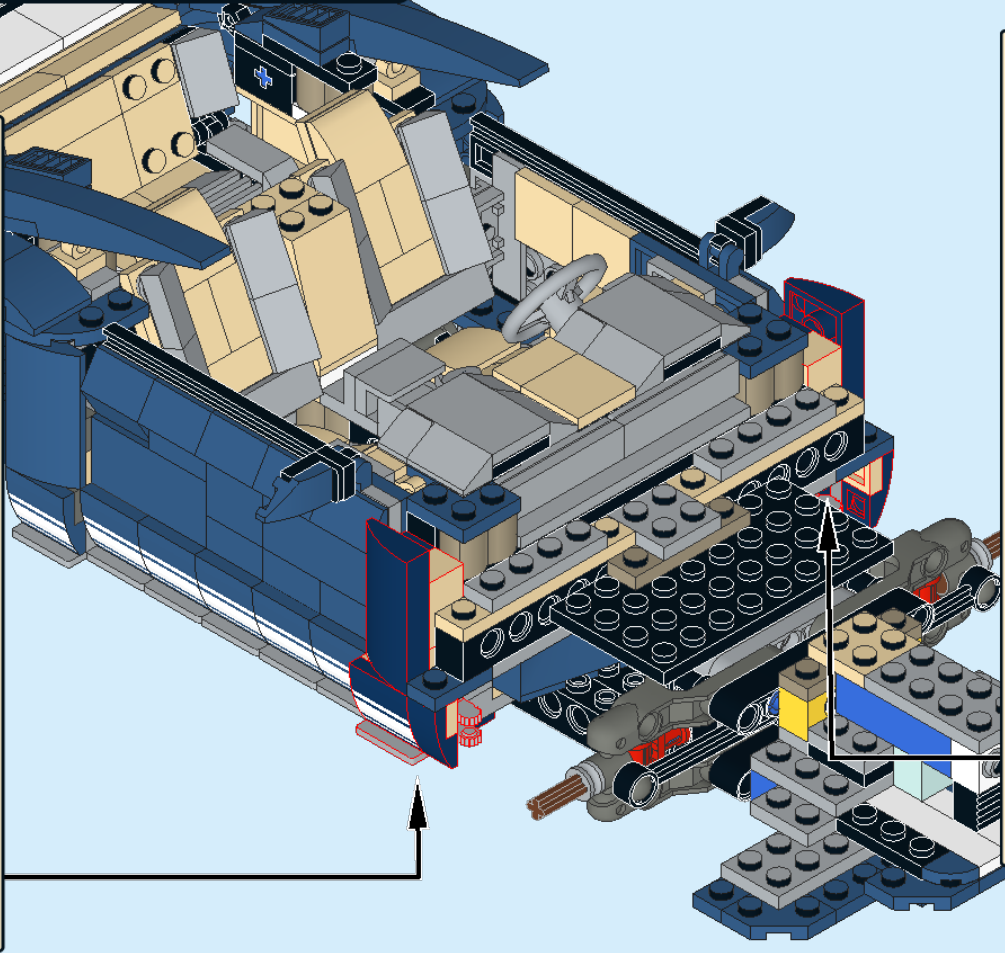
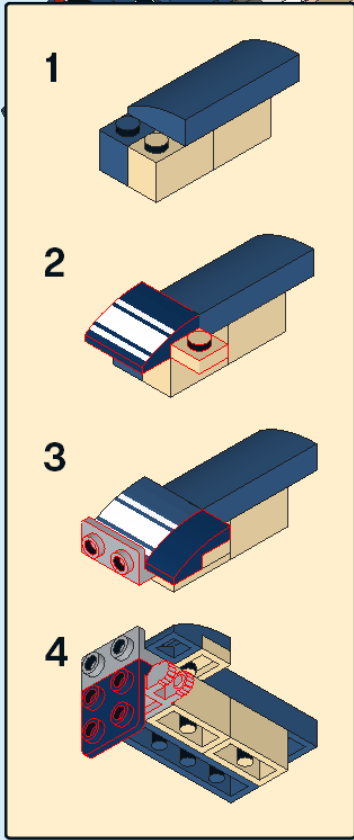
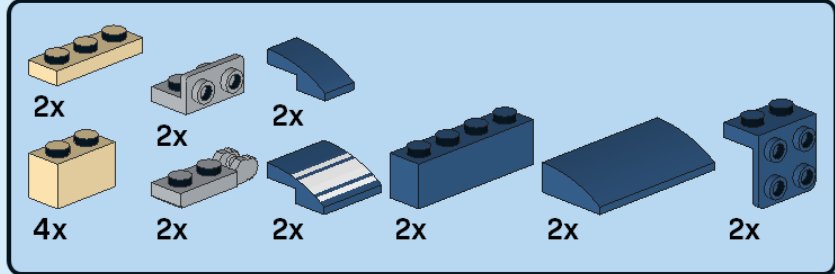

94

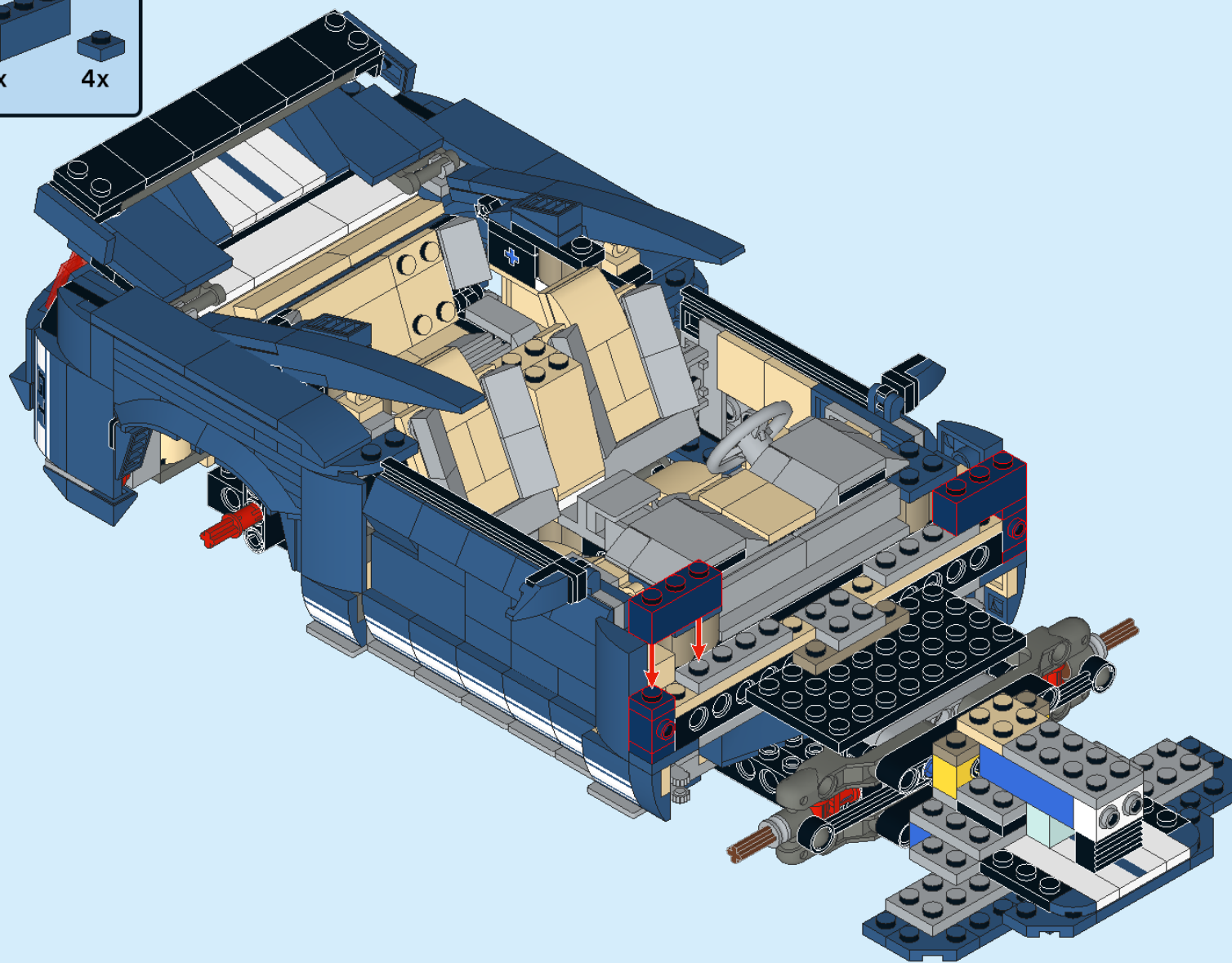
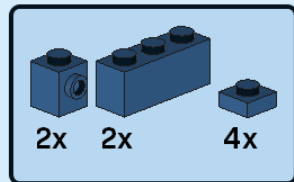

96

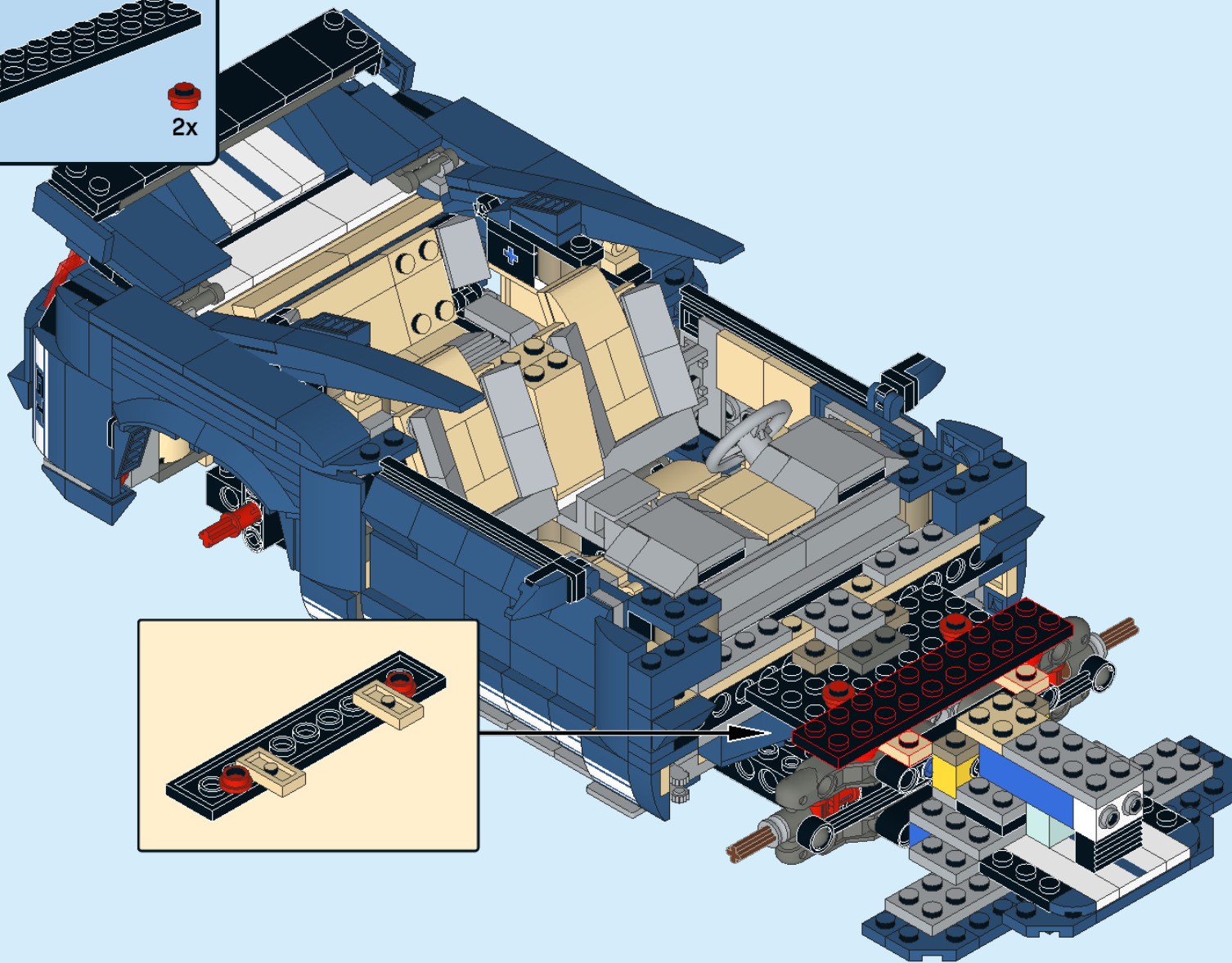
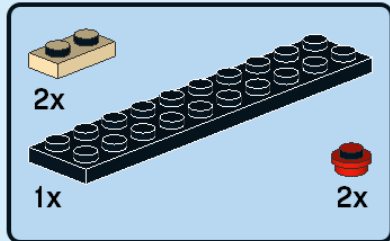

97

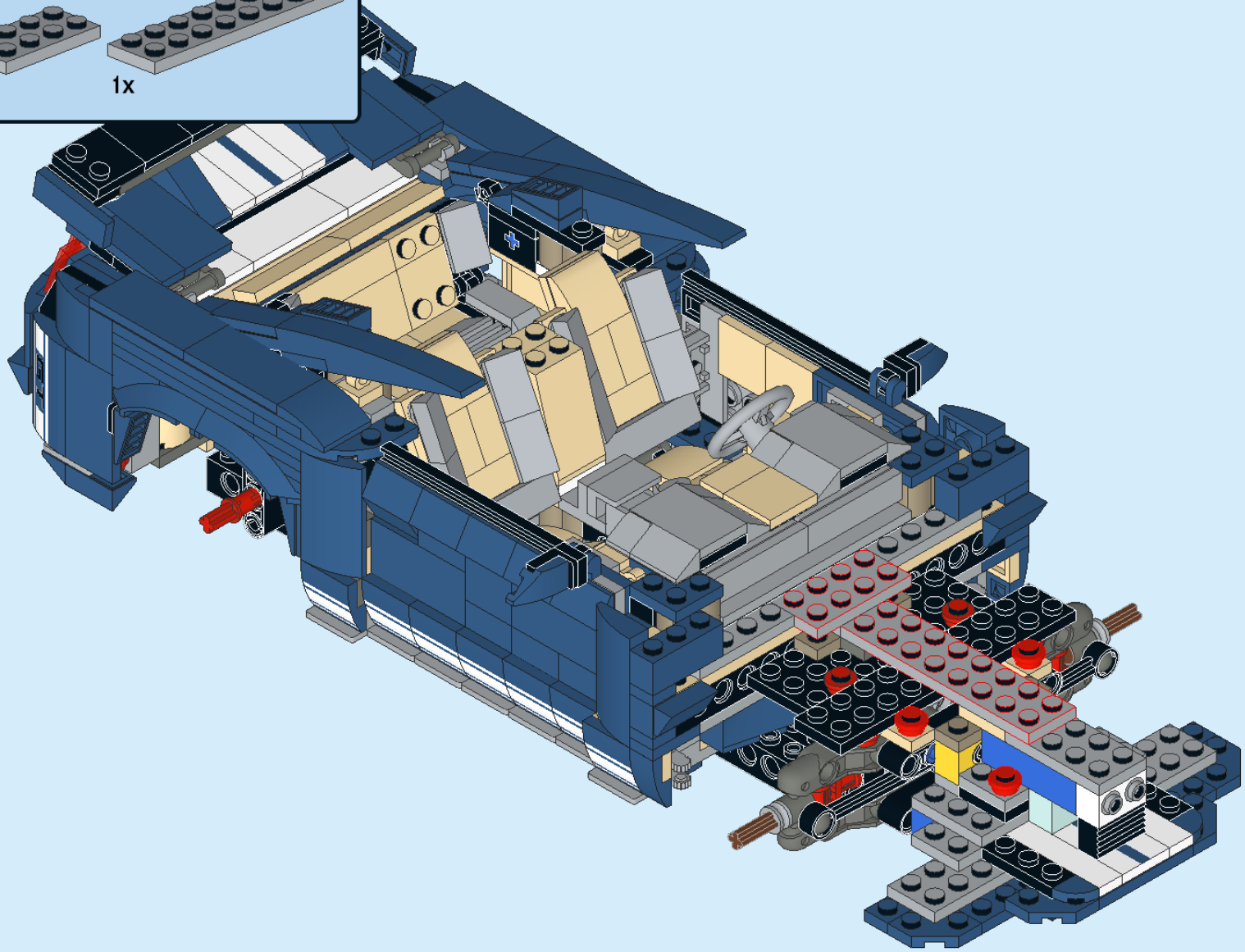
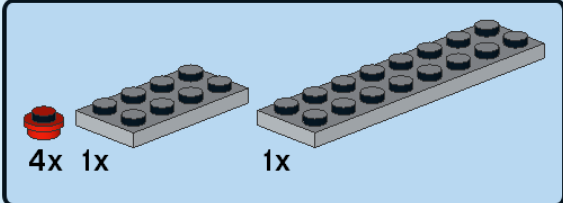

98

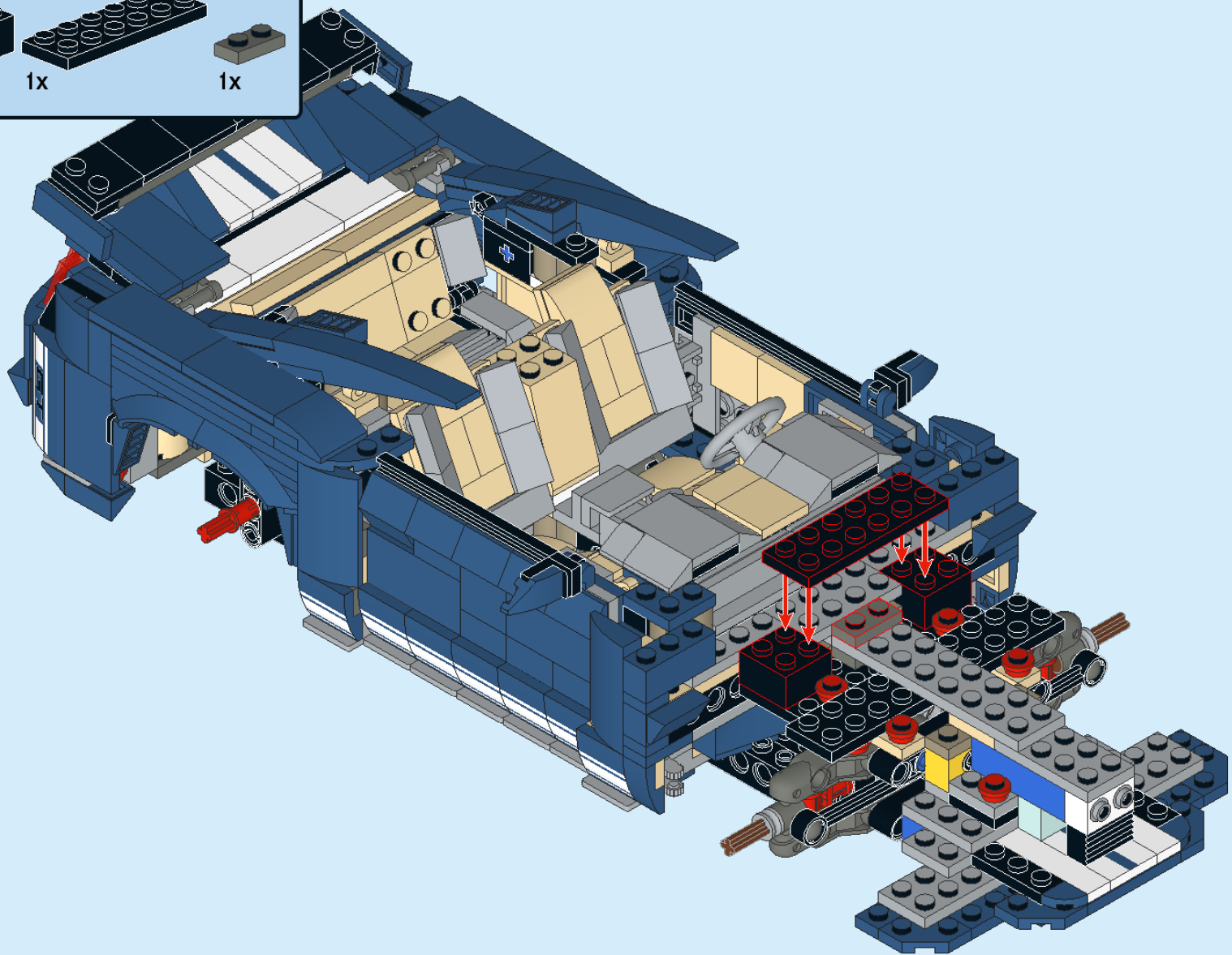
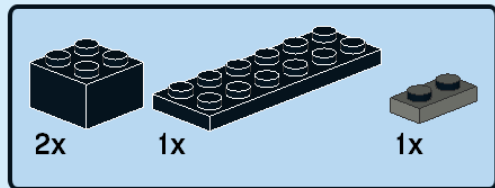

99

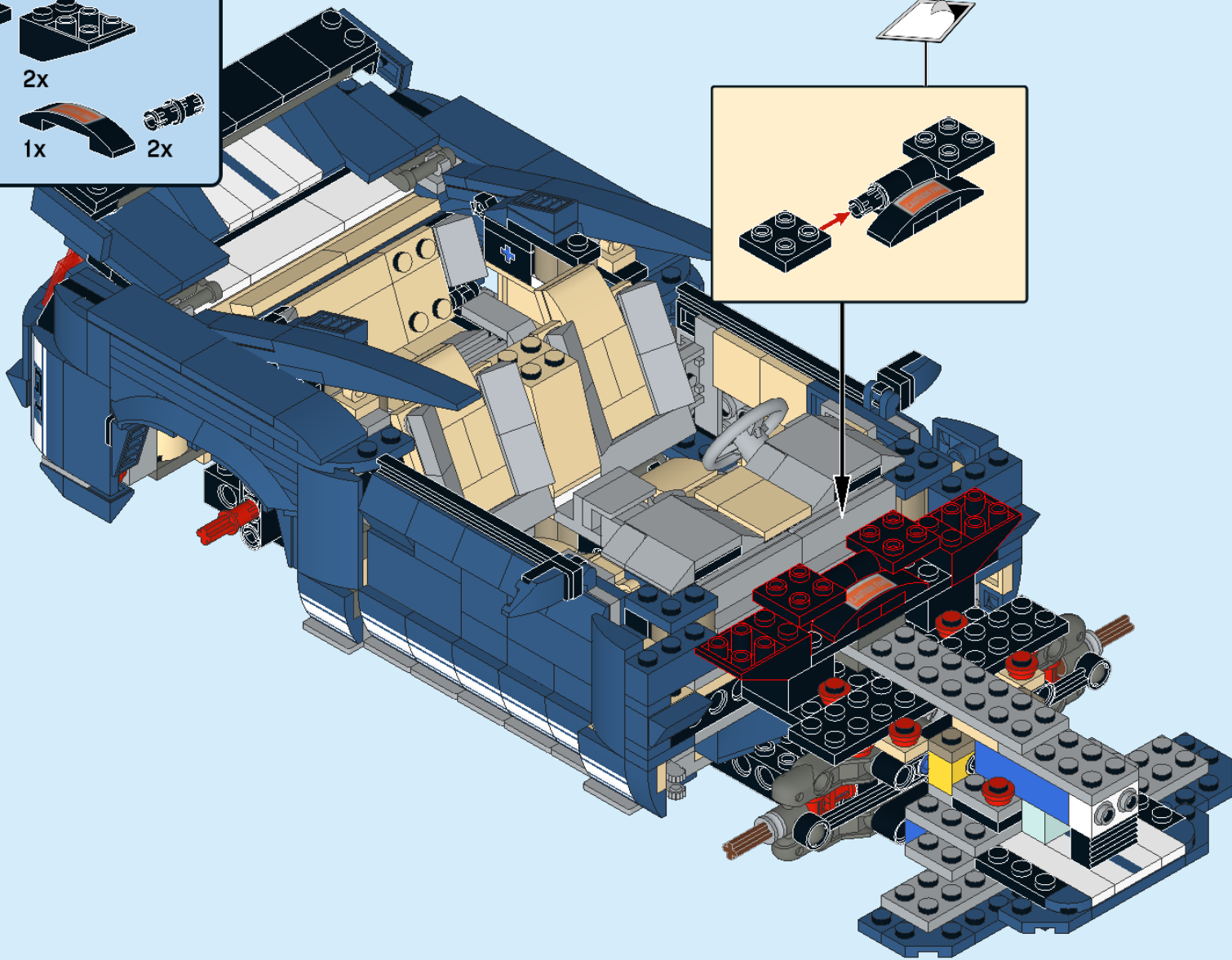
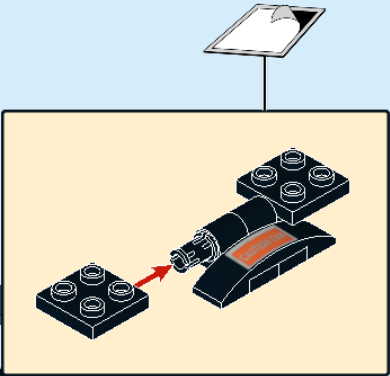
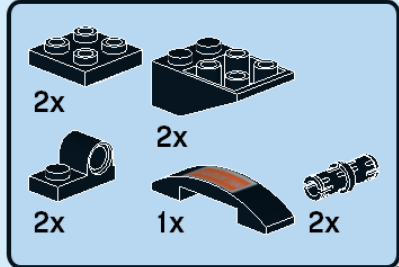

100

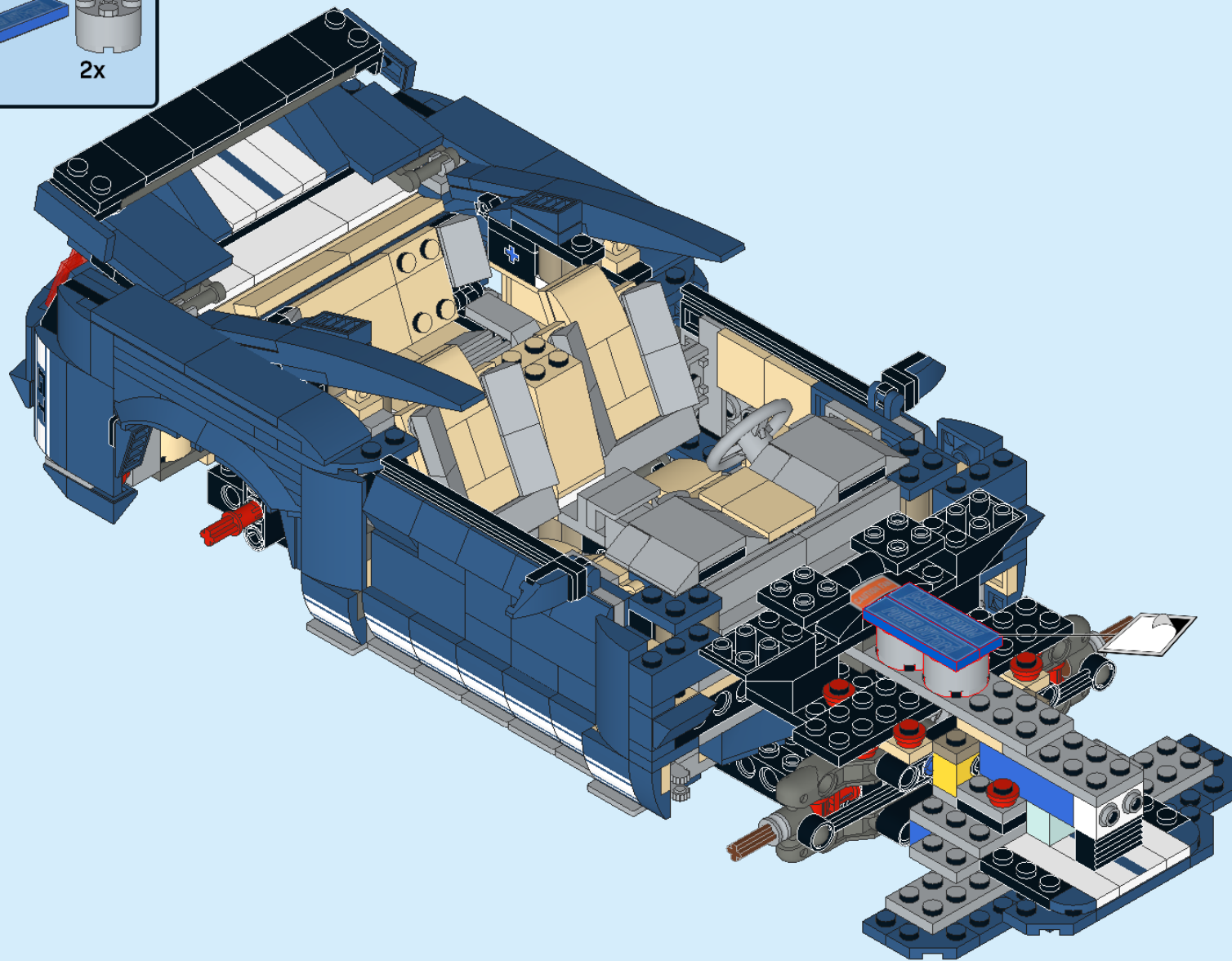
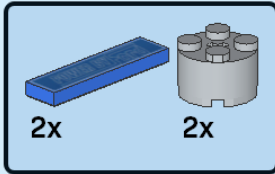

101

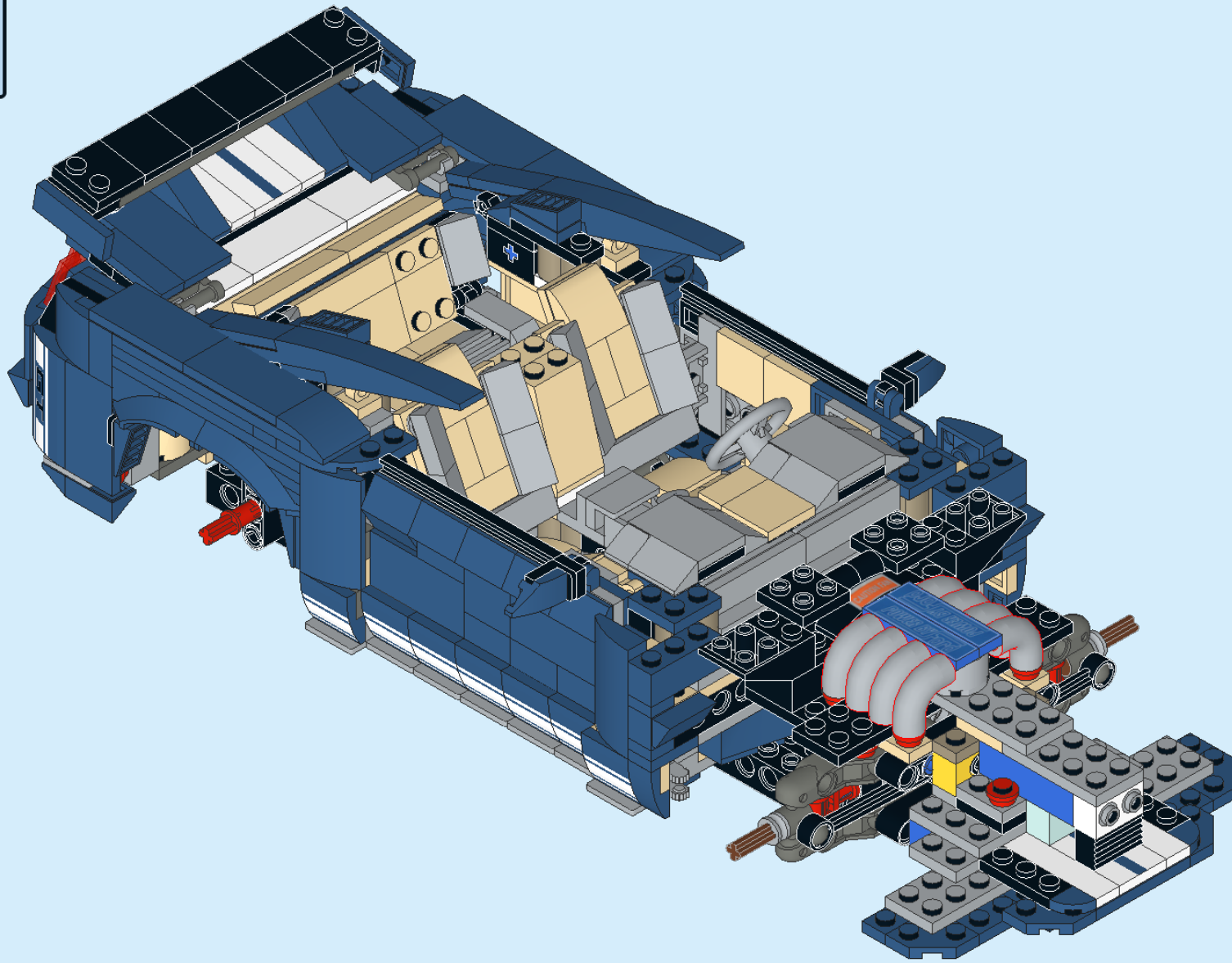
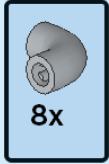

102

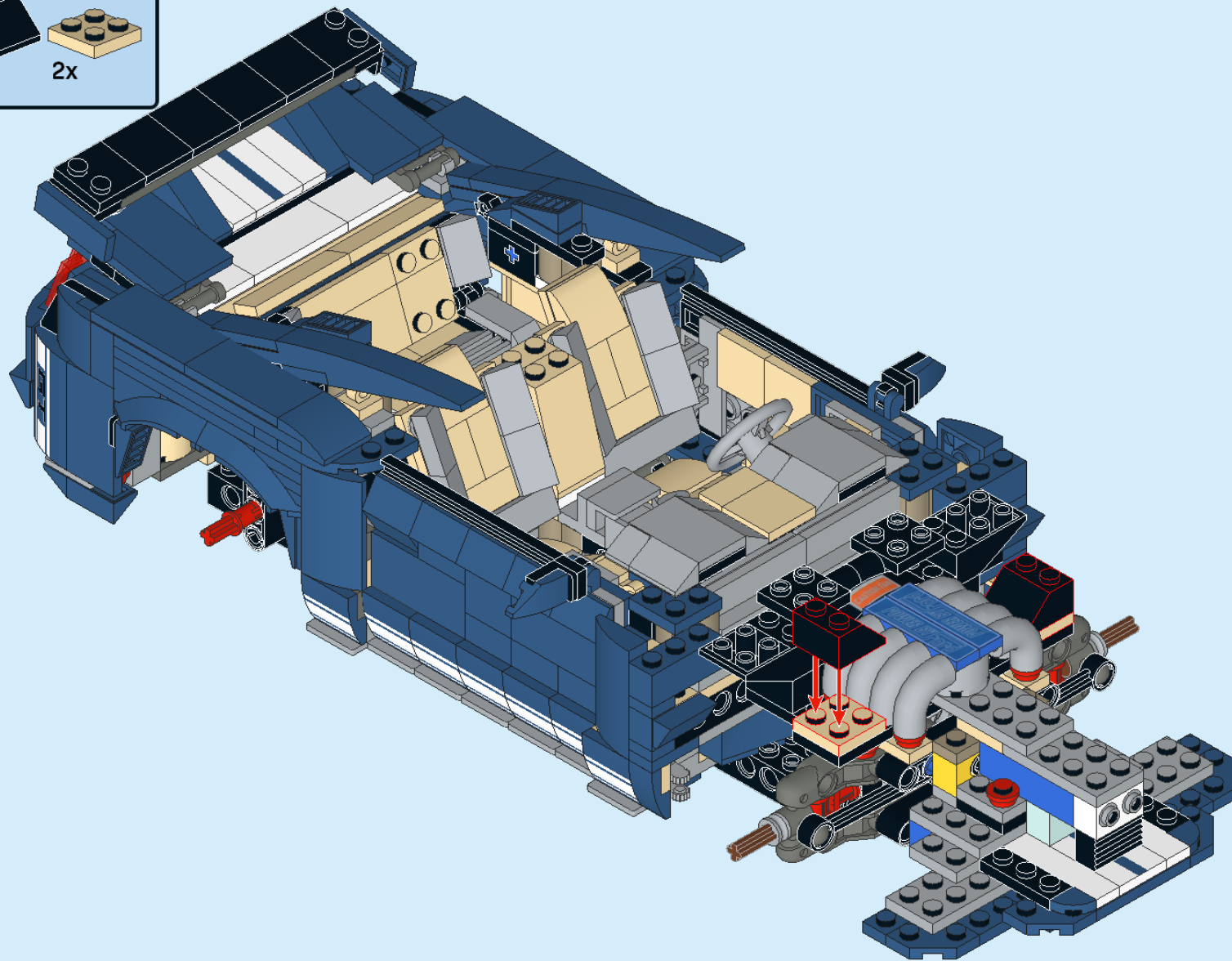
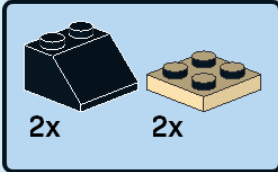

103

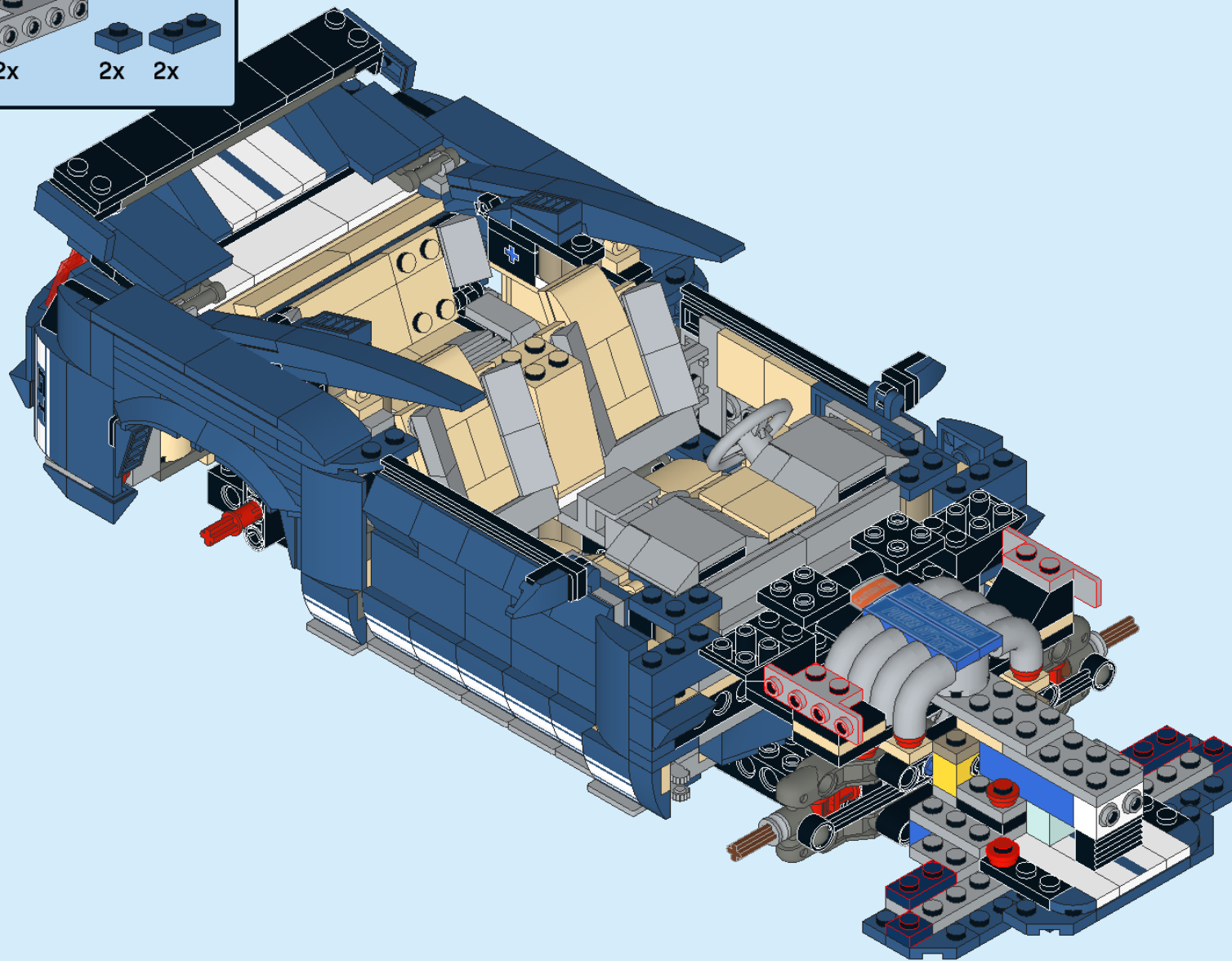
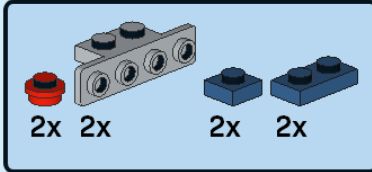

104

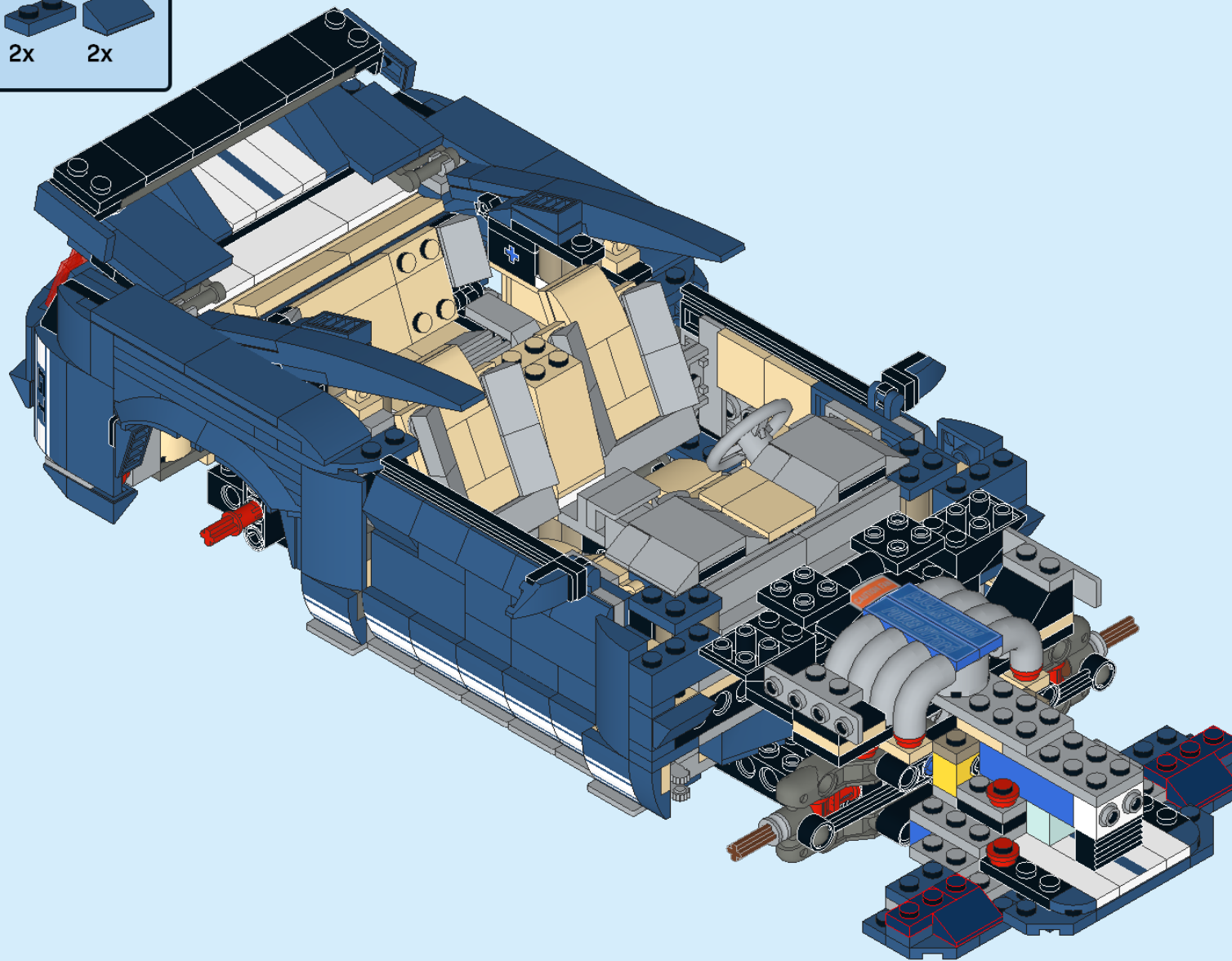
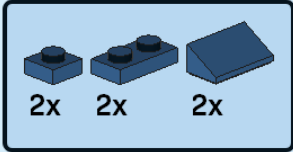

105

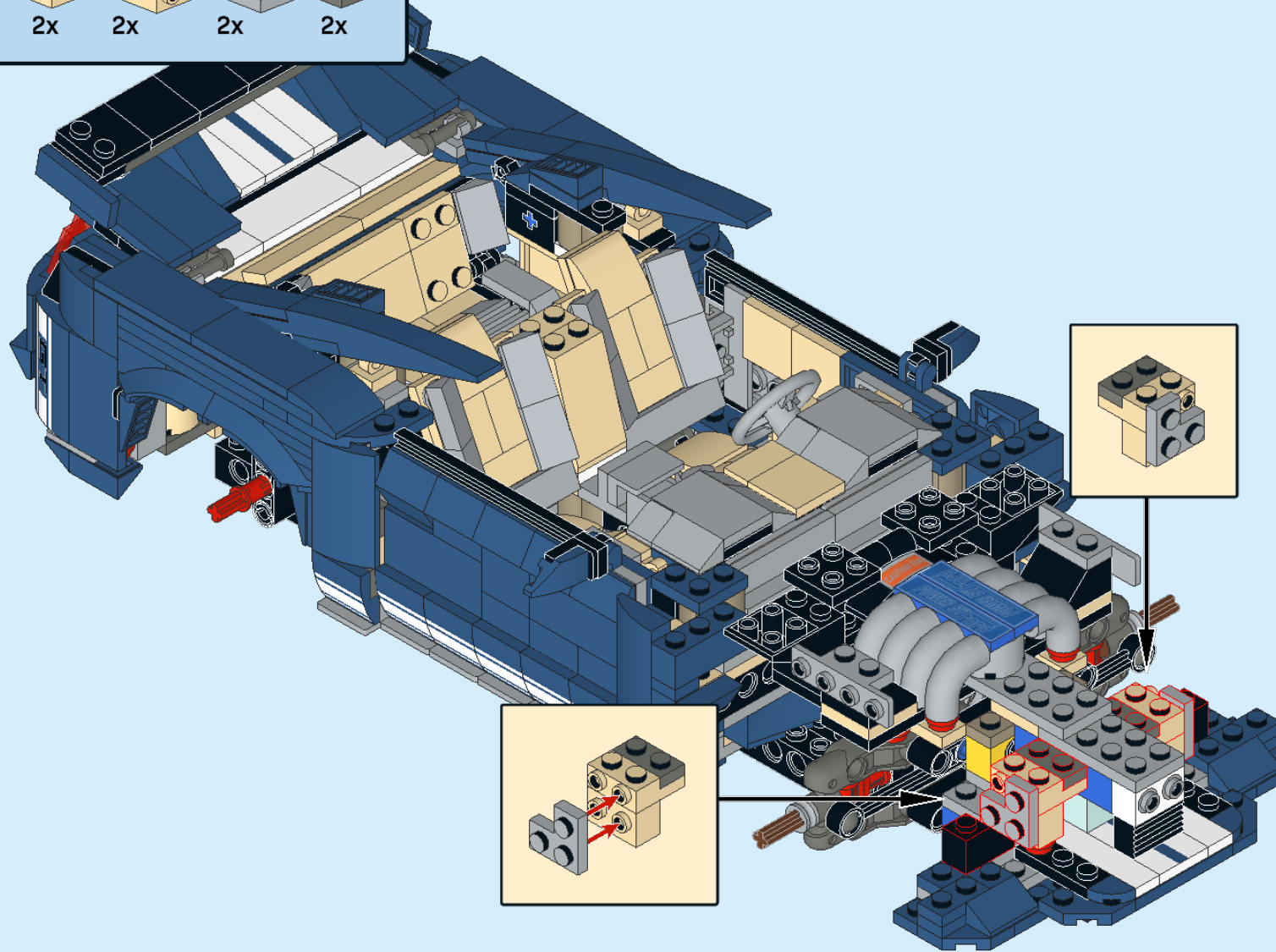
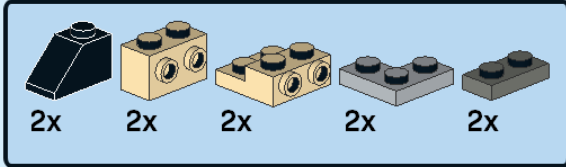

106

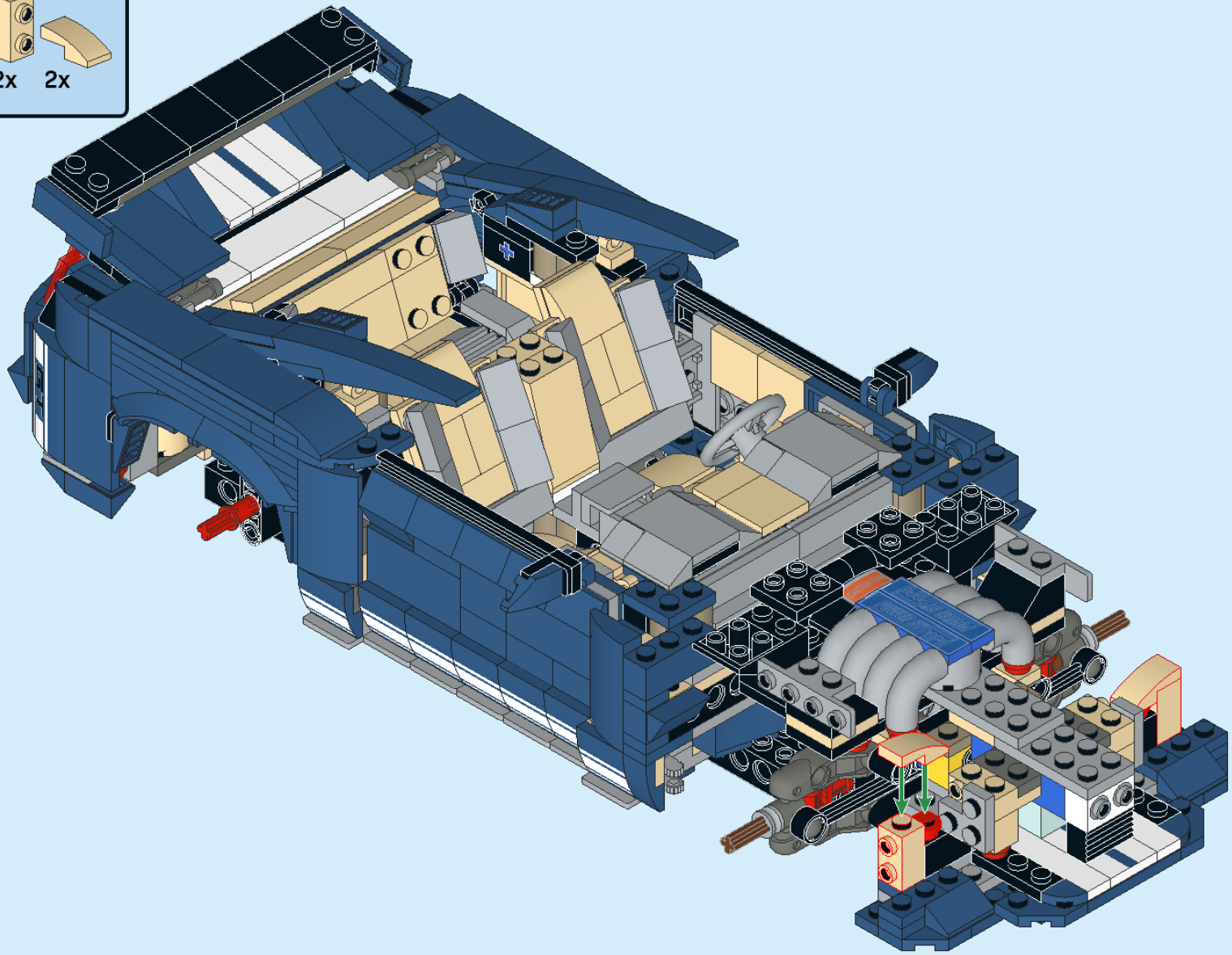
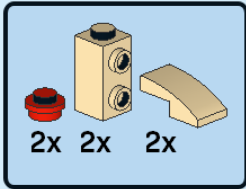

107

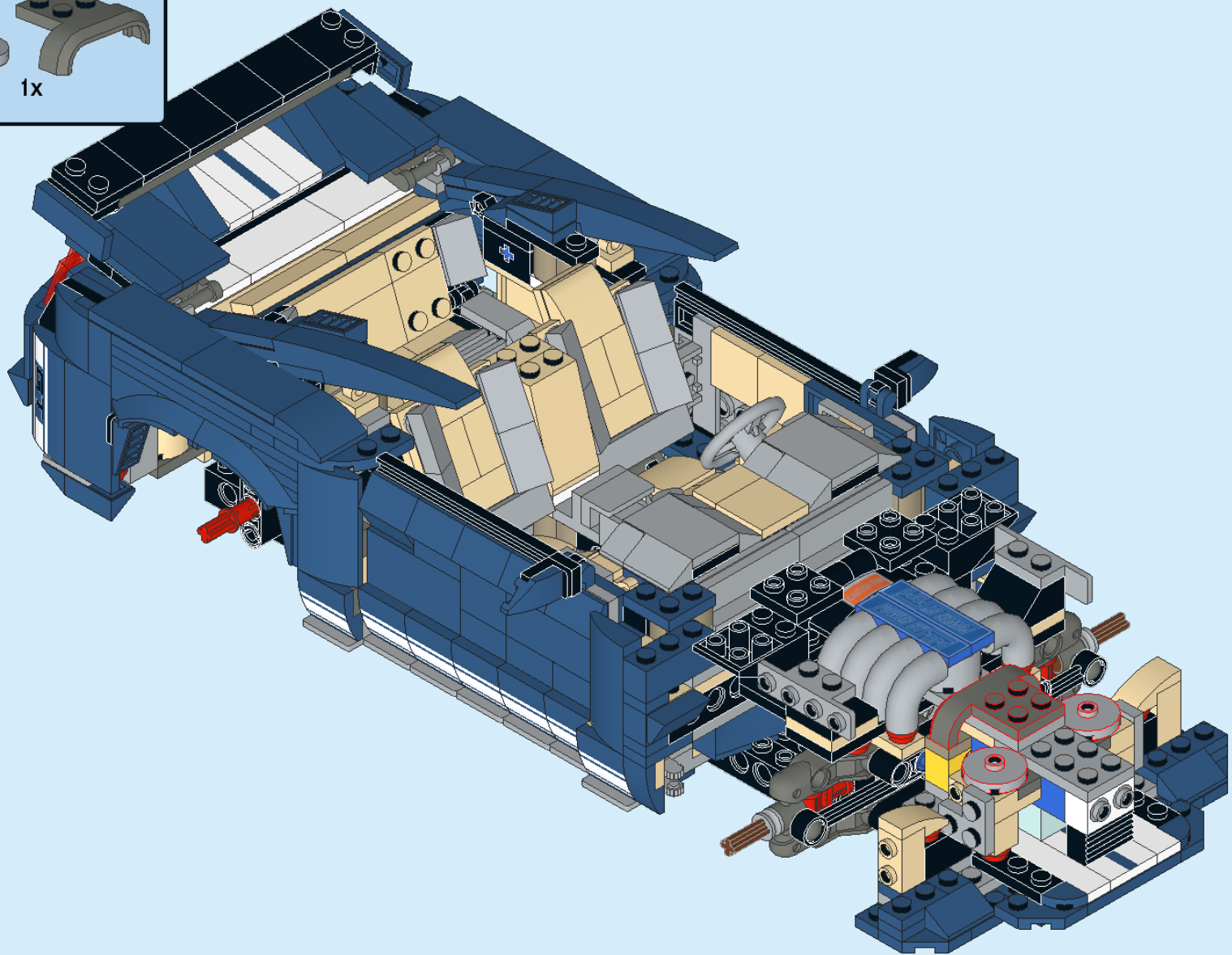
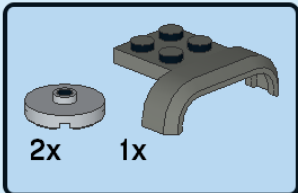

108

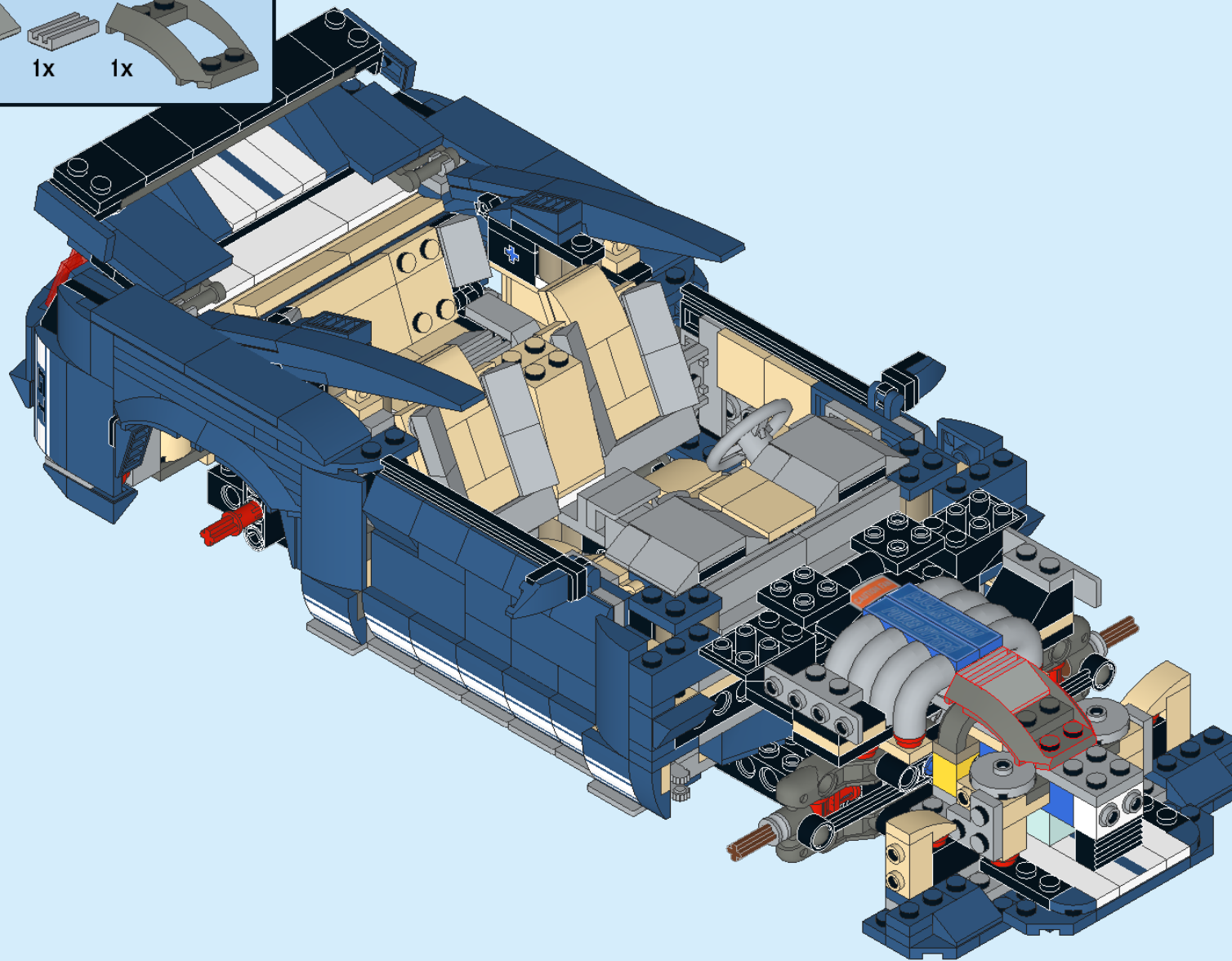
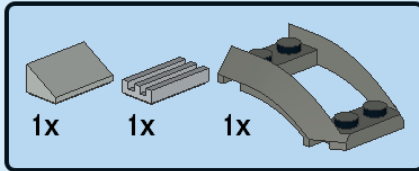

109

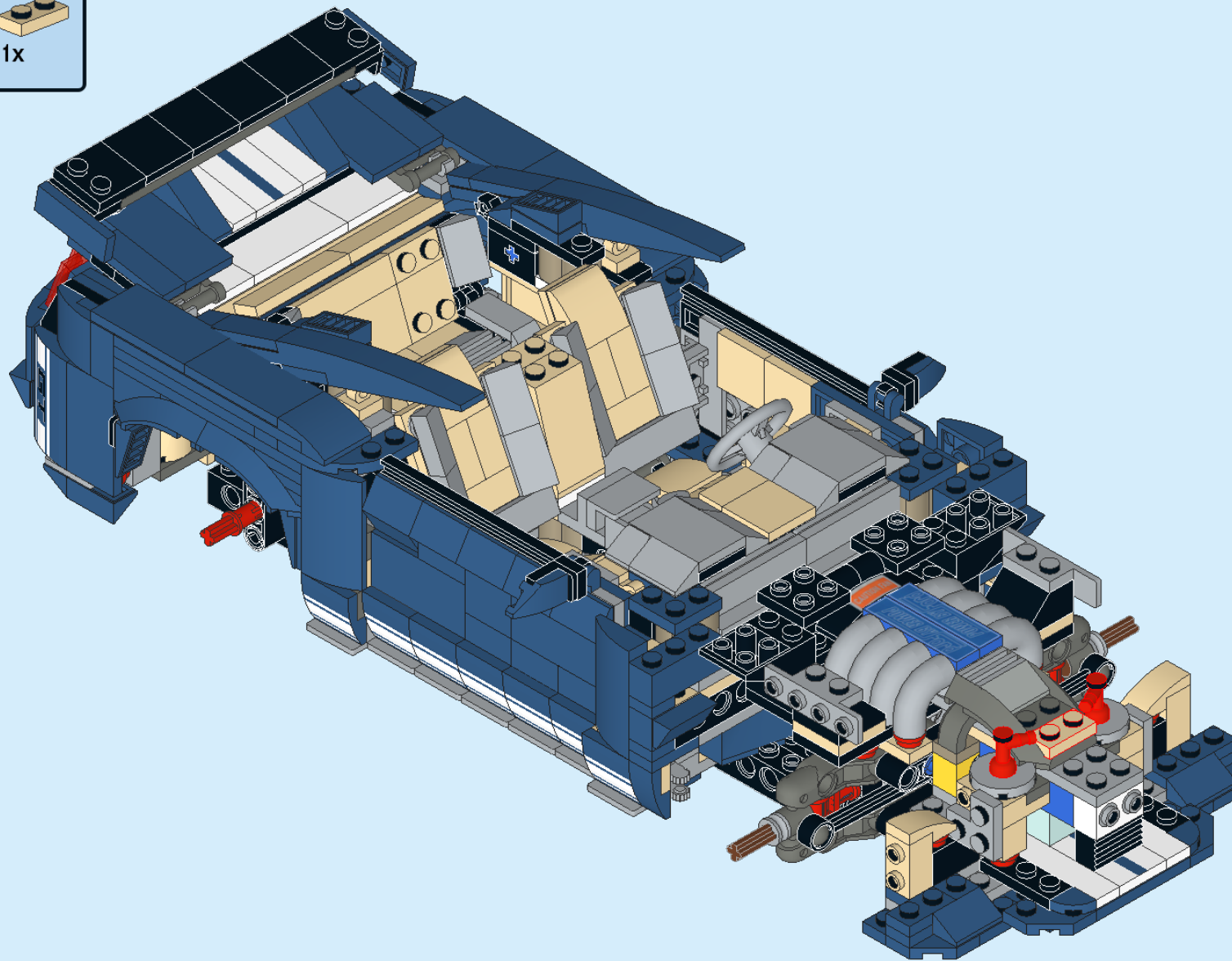
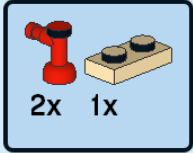

110

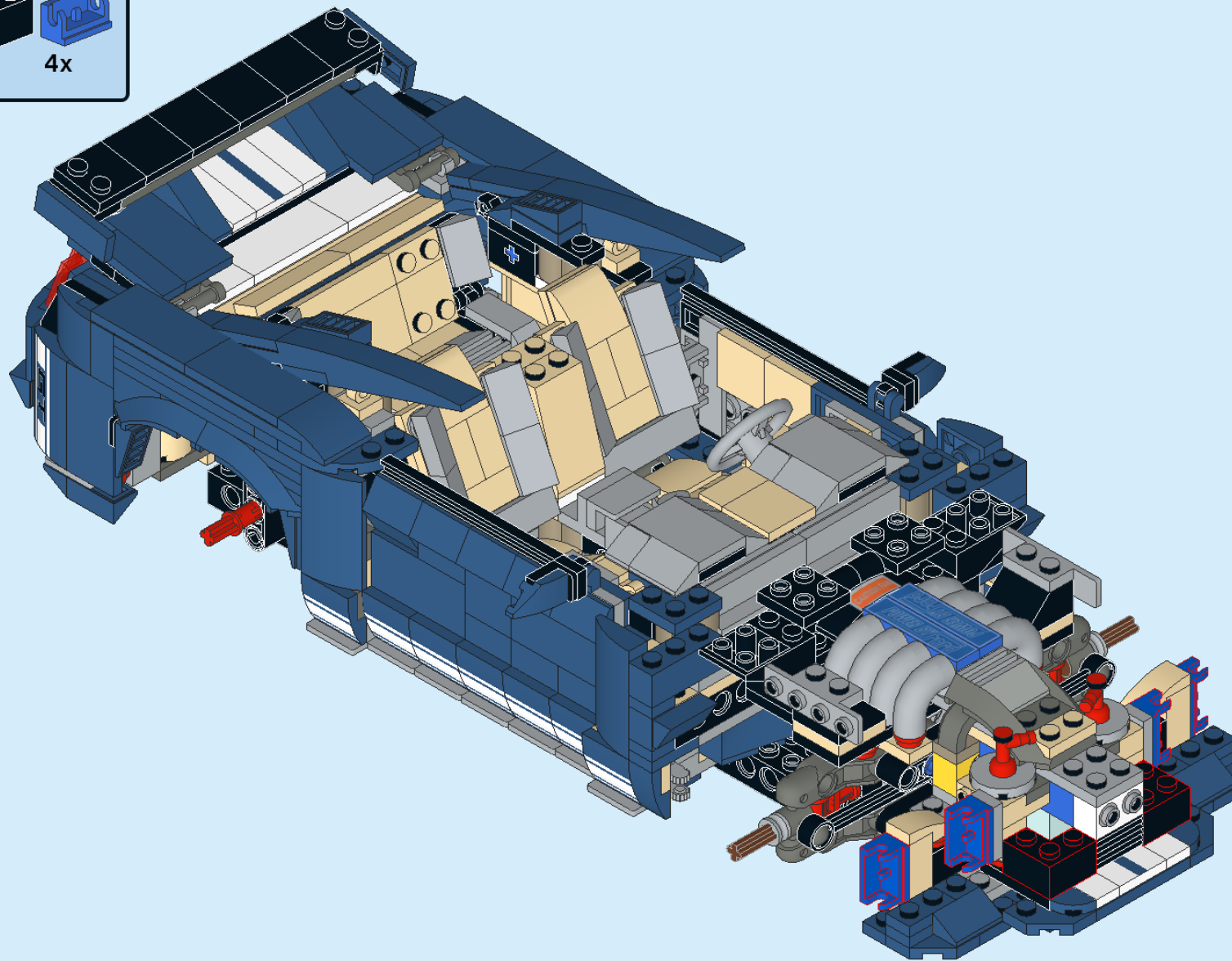
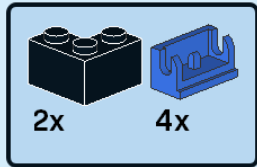

111

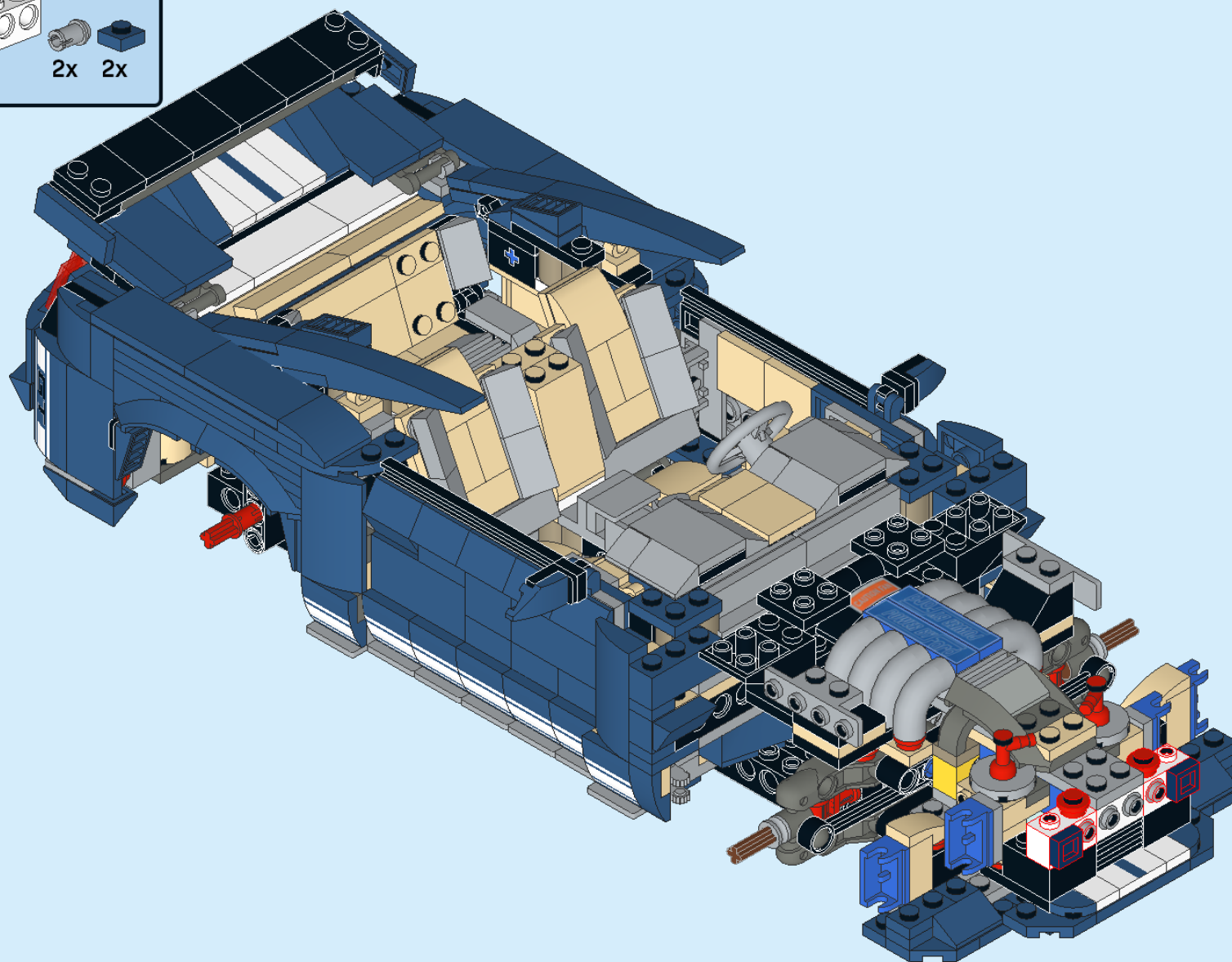
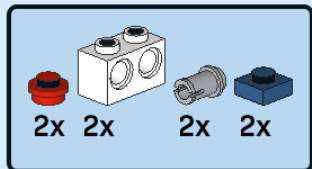

112

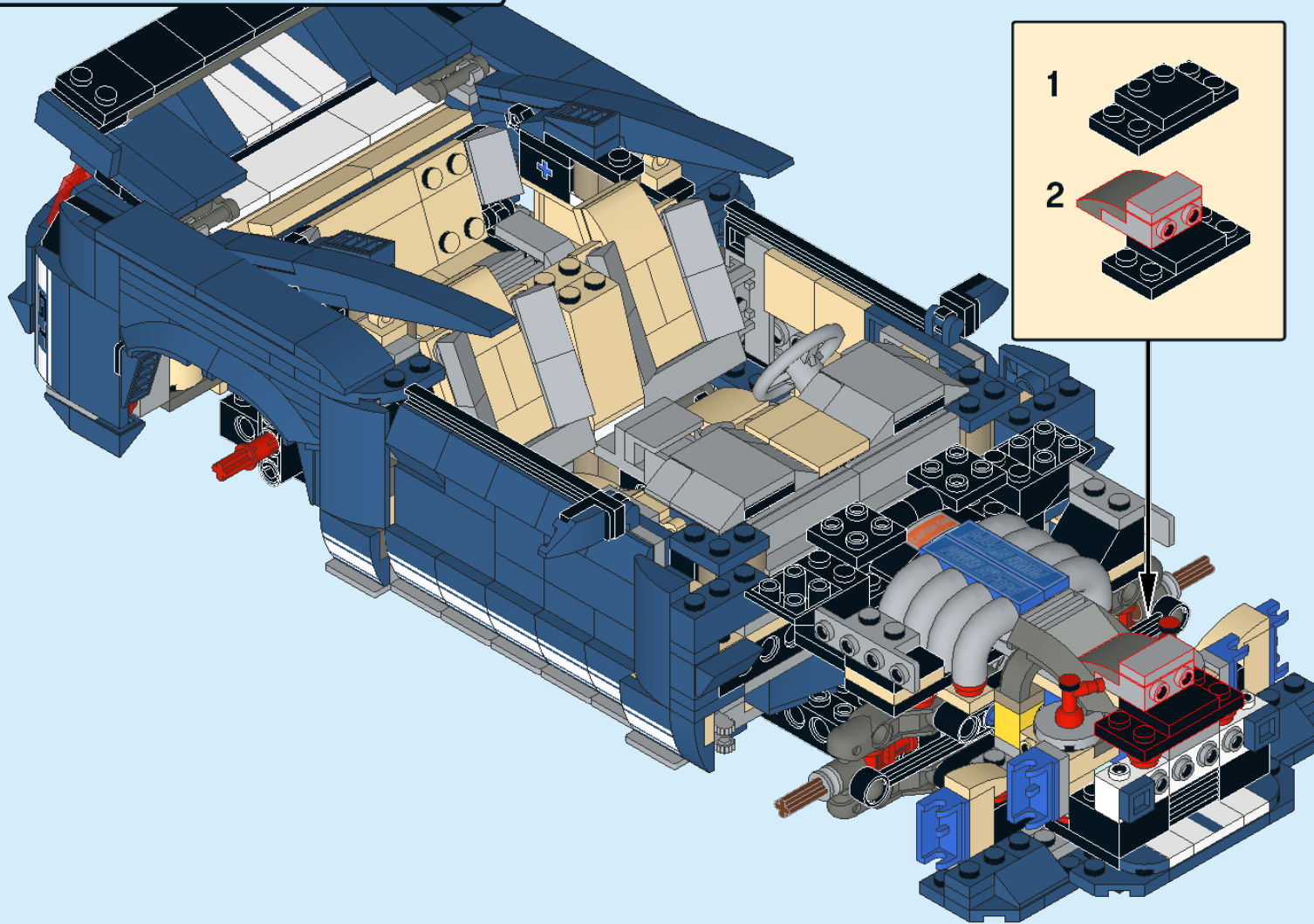
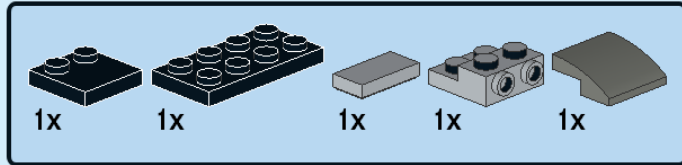

113

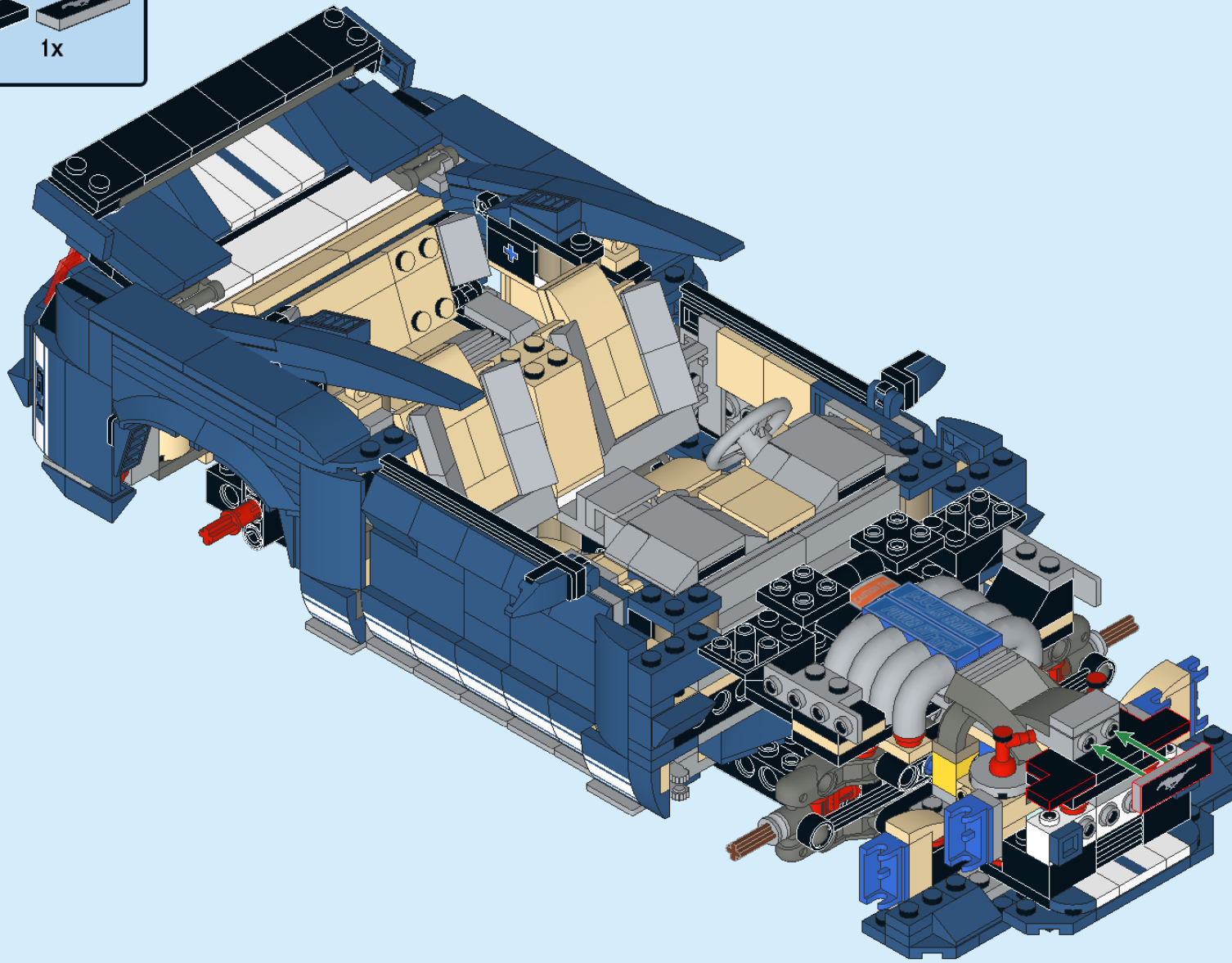
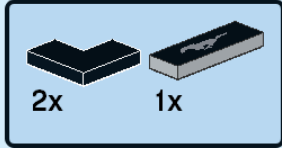

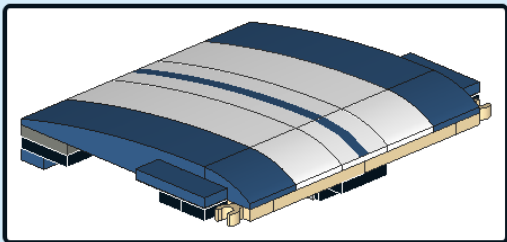

1

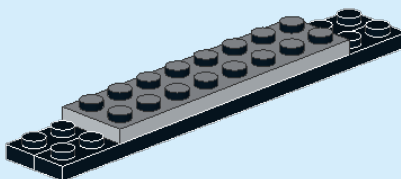
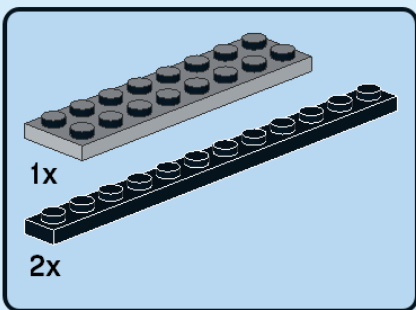

2

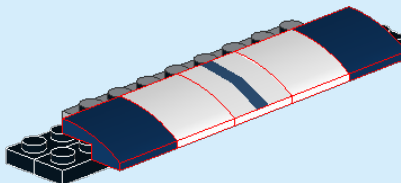
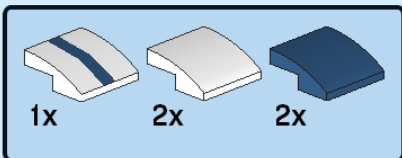

3

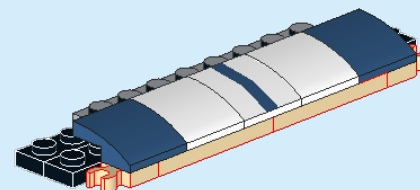
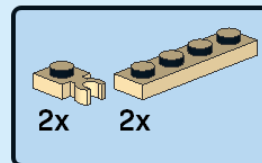

4

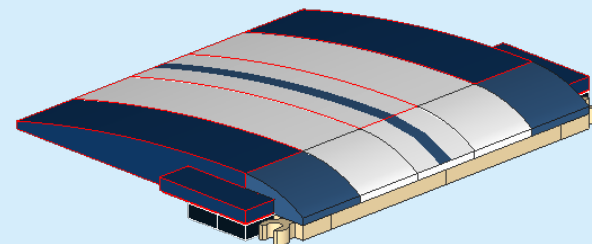
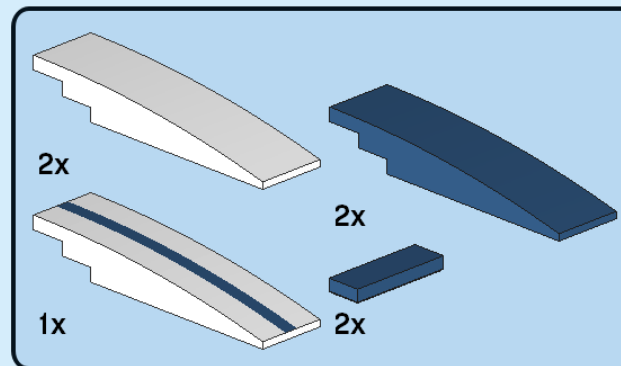

5

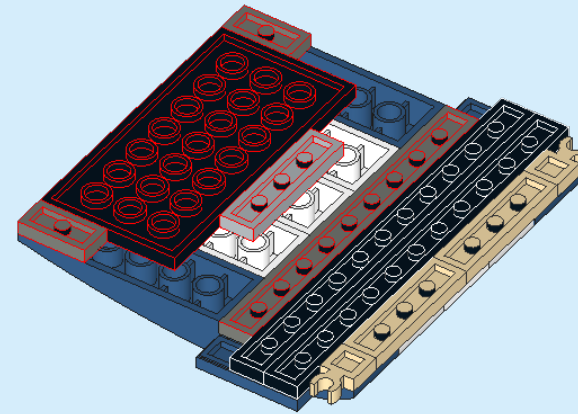
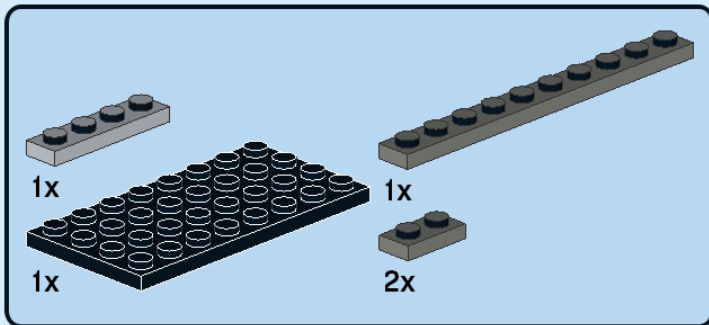

6

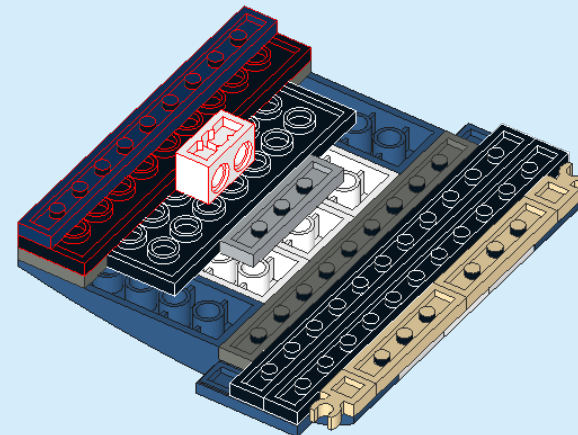
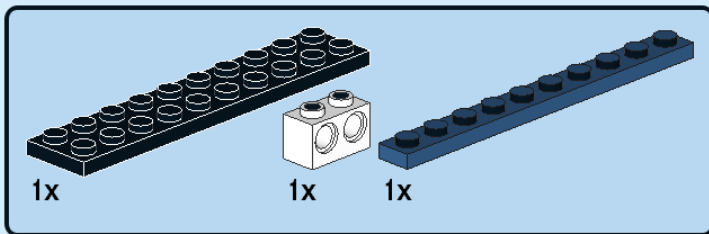

7

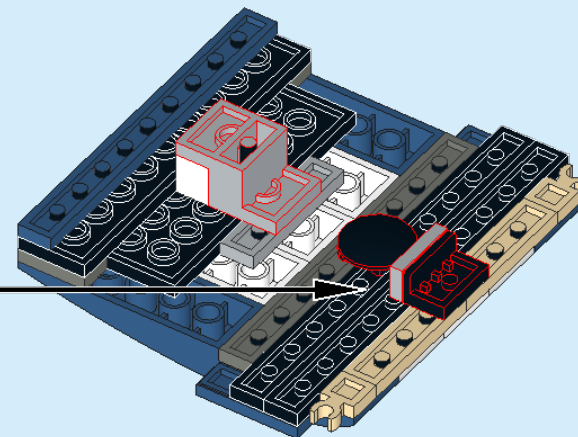
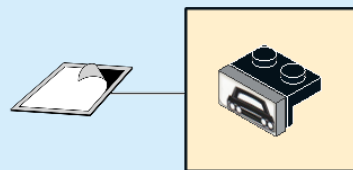
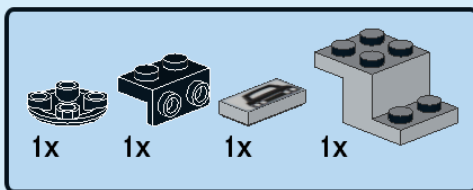

114

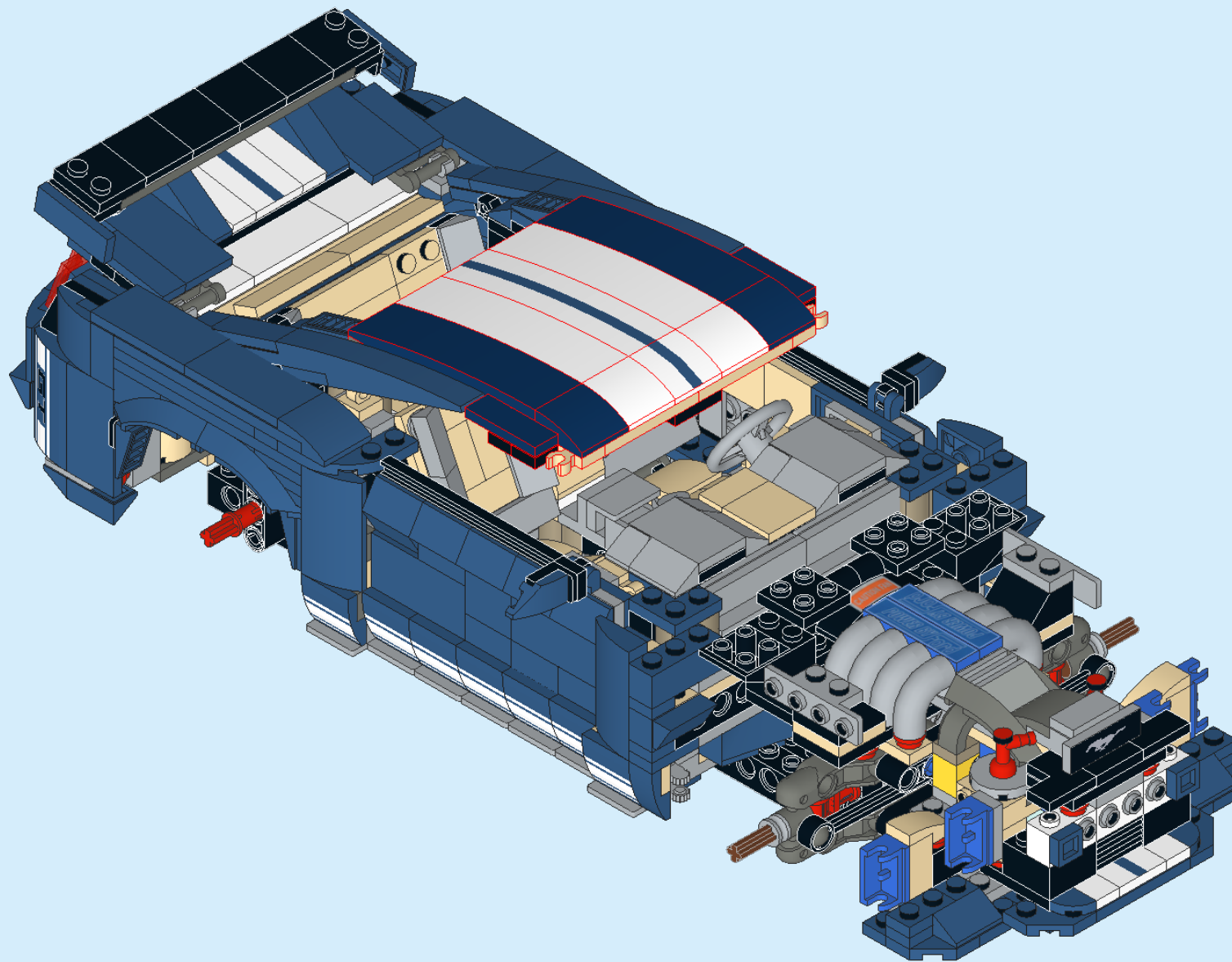

115

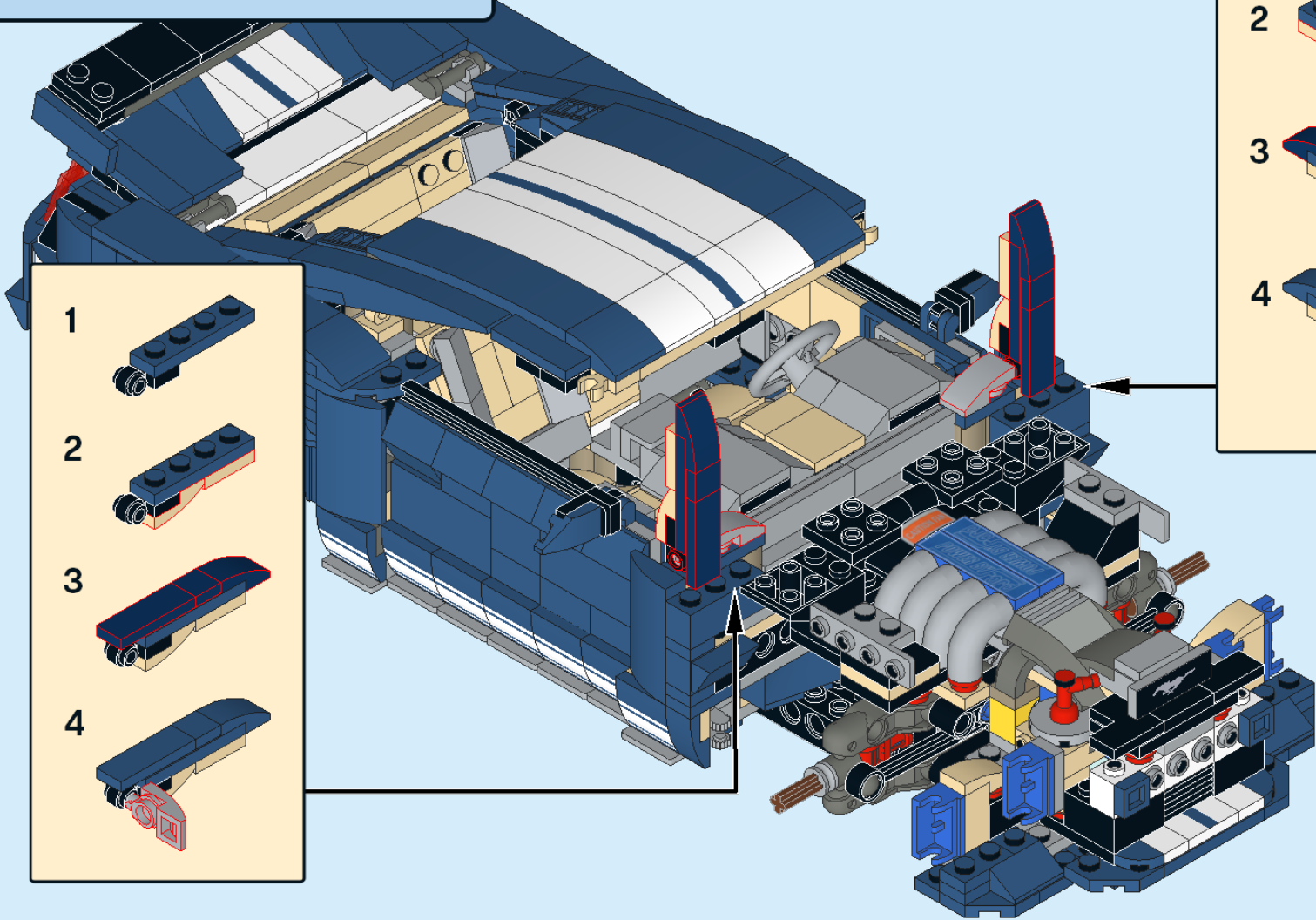
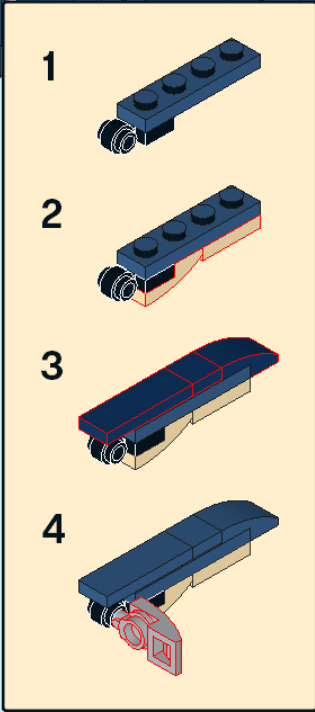
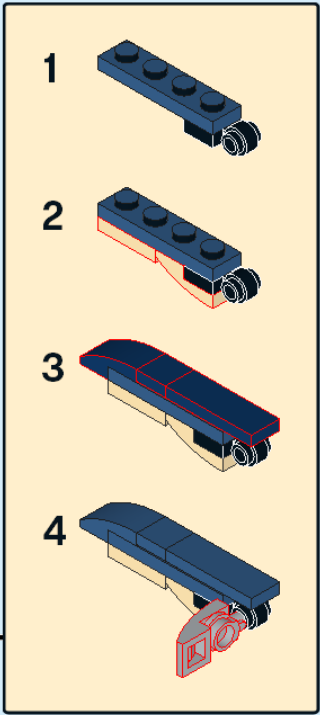
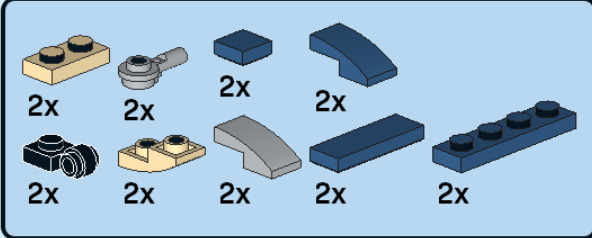

116

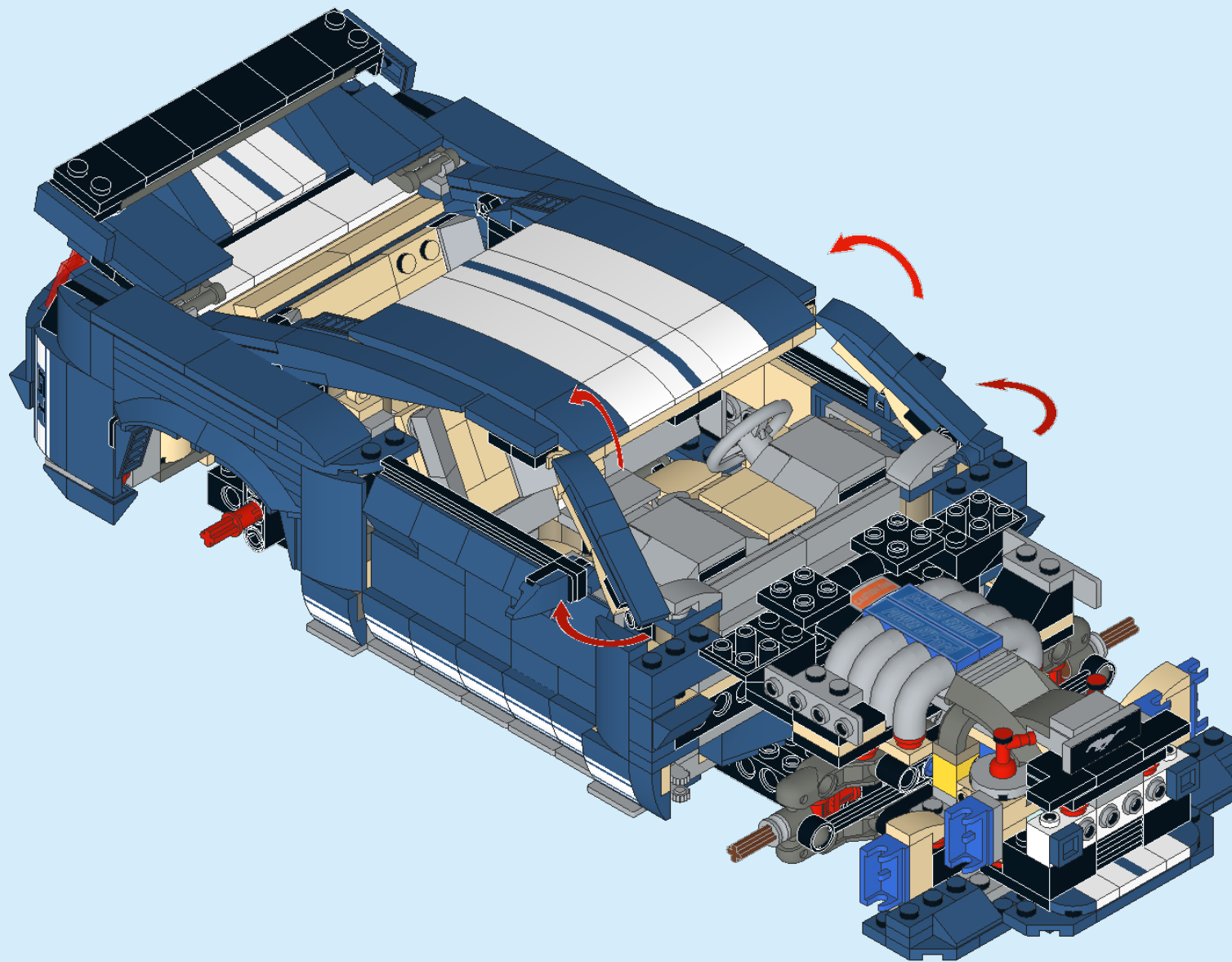

117

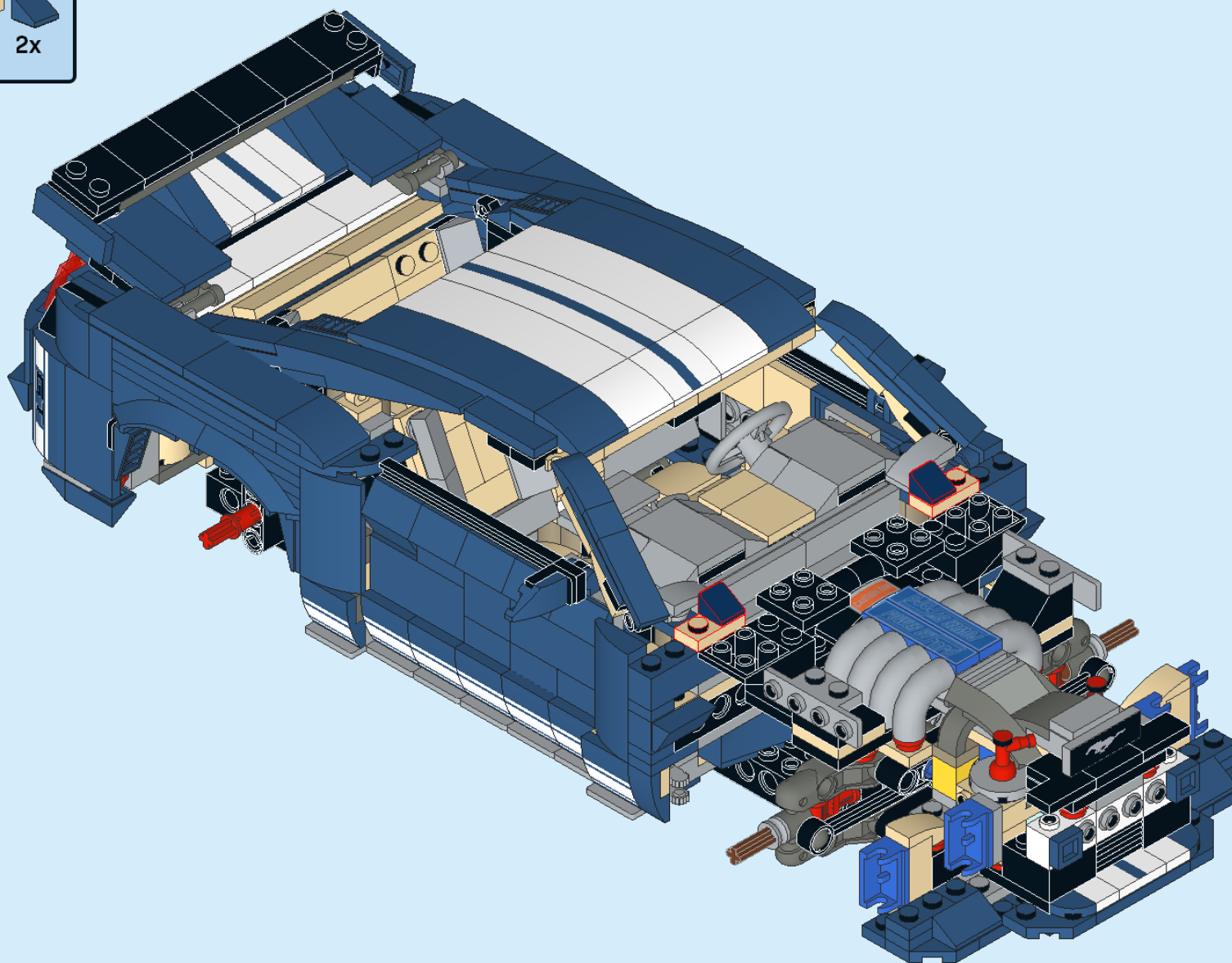
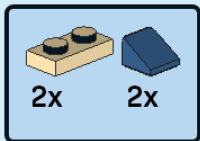

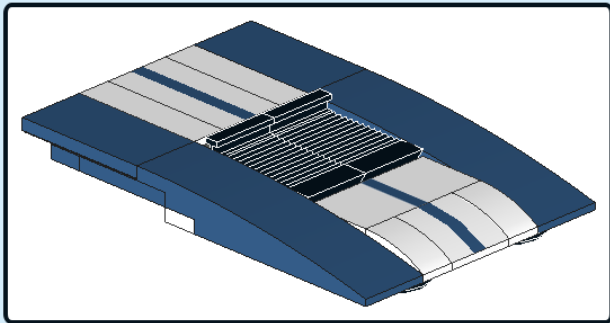

1

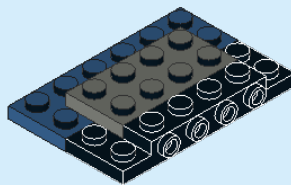
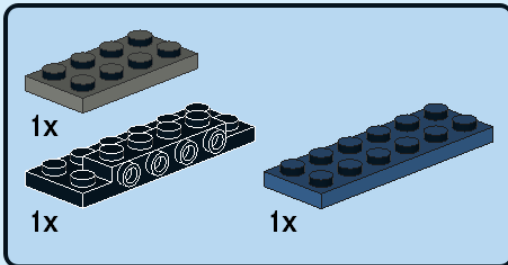

2

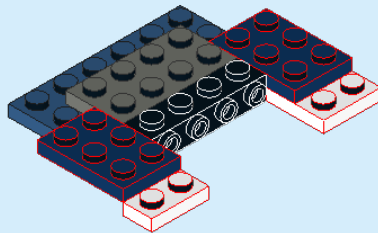
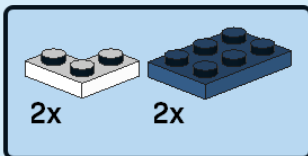

3

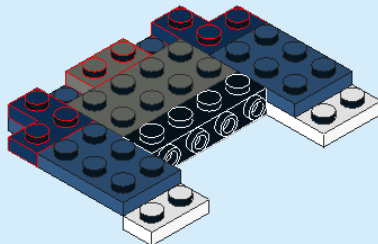
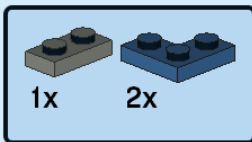

4

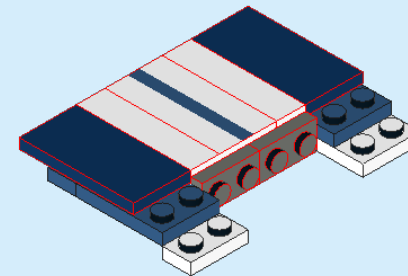
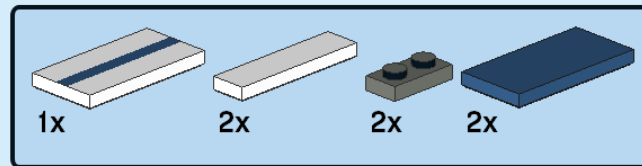

5

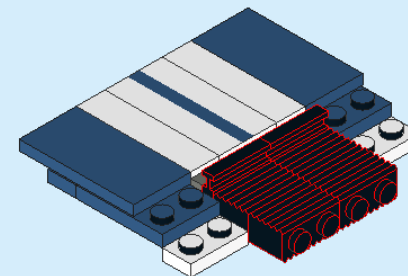
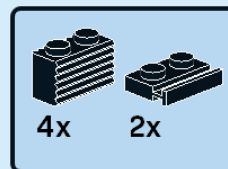

6

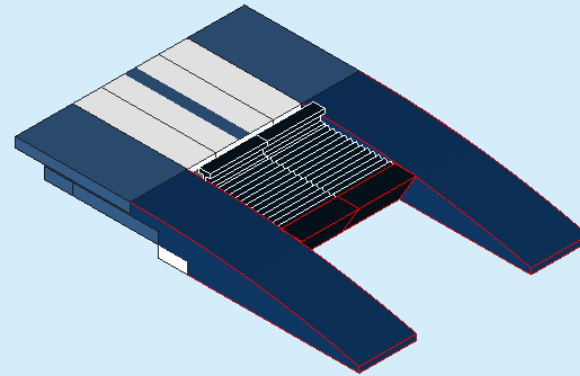
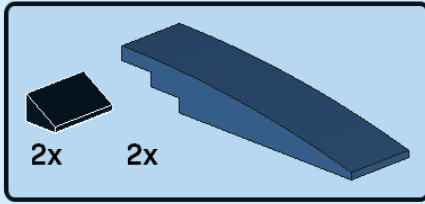

7

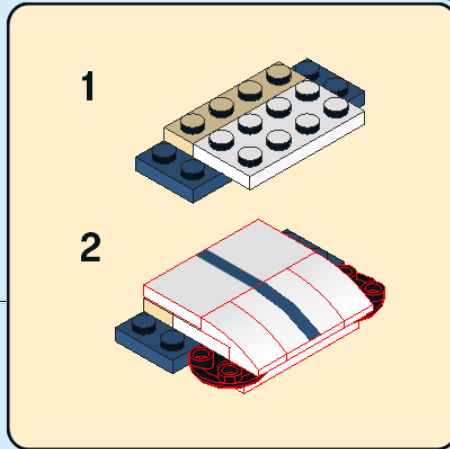
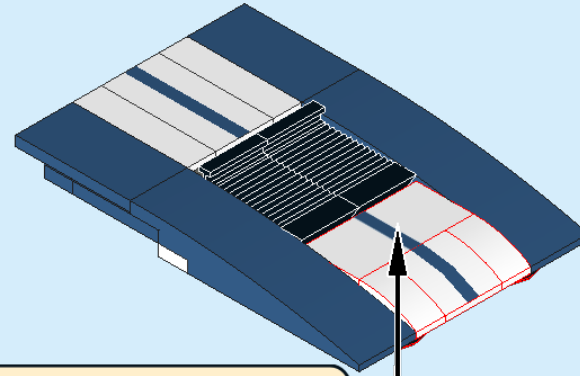
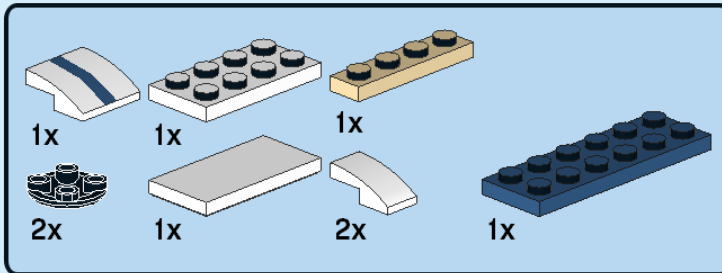

(*) Cut the blue stripe from the set license plate sticker as shown on page 169

118

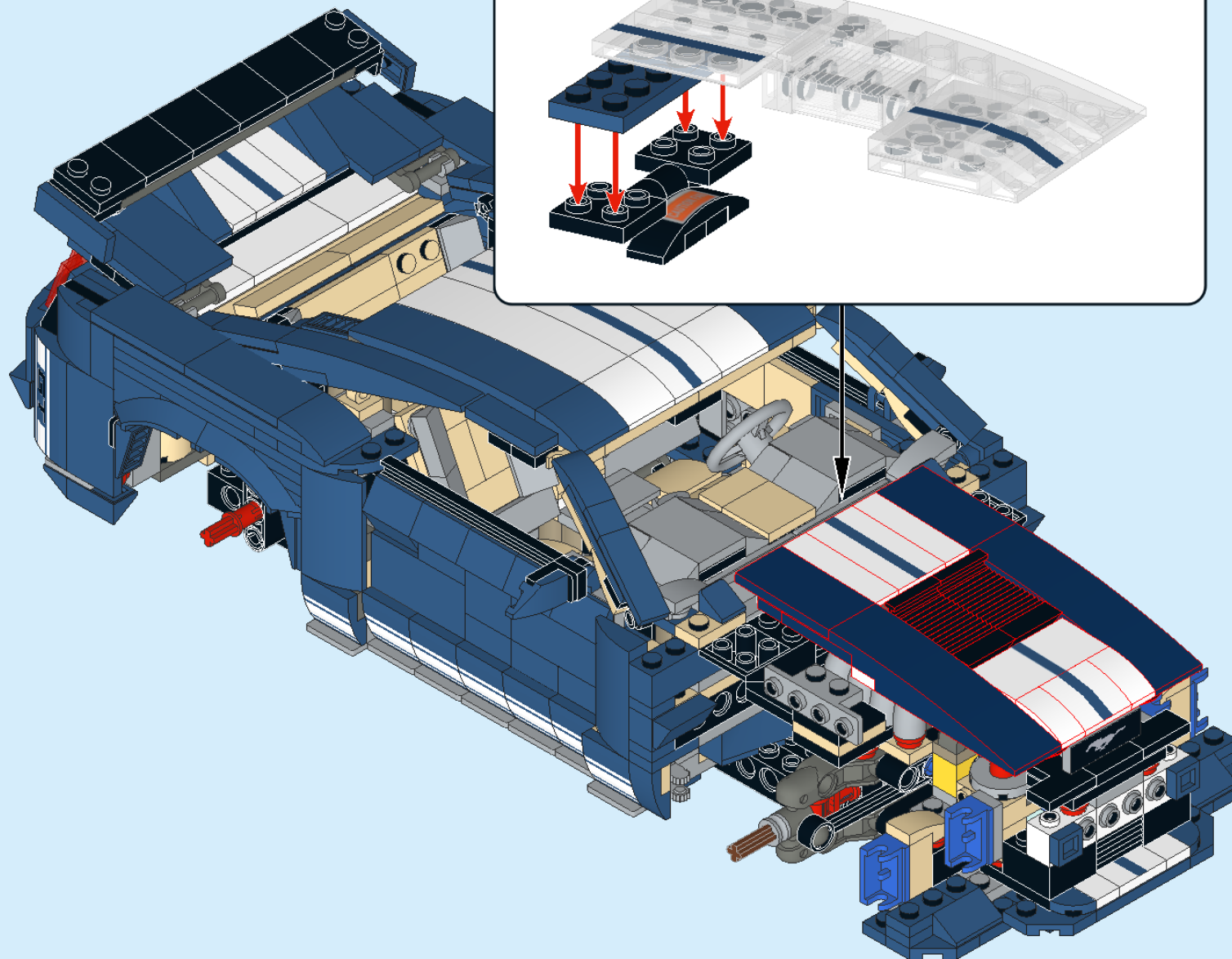

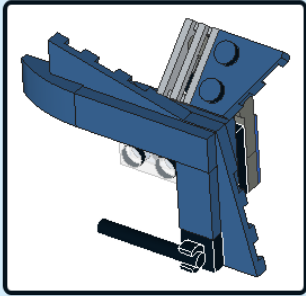

1

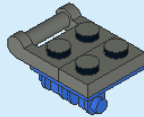
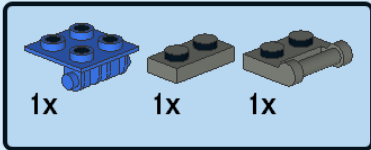

2

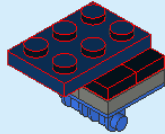
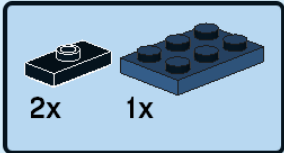

3

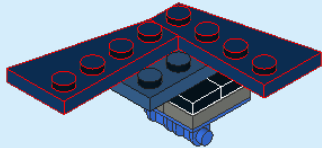
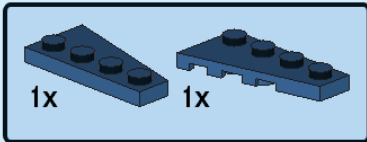

4

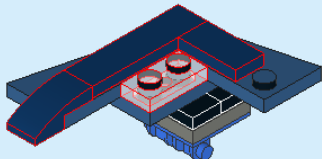
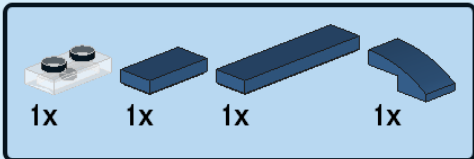

5

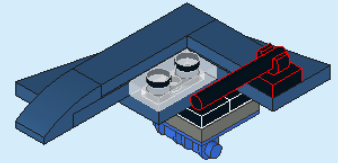
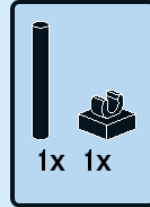

6

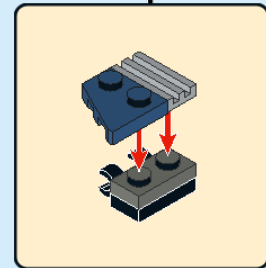
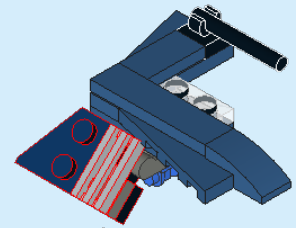
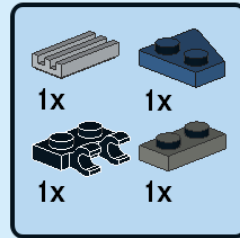

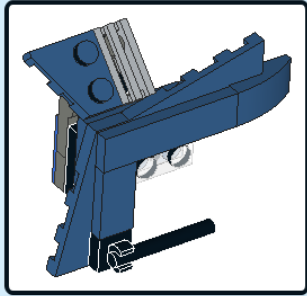

1

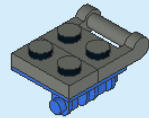
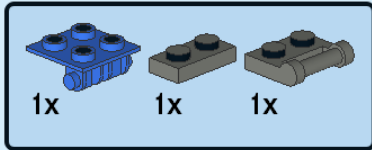

2

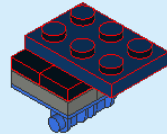
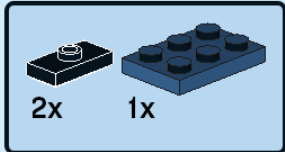

3

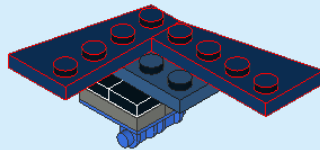
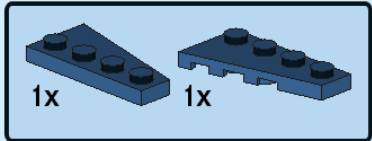

4

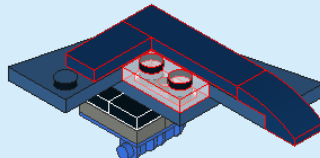
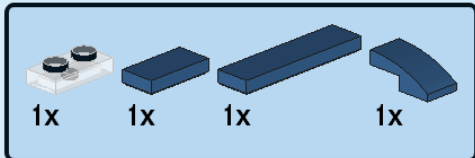

5

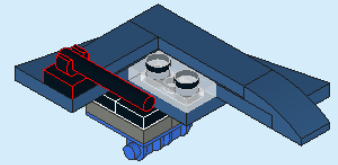
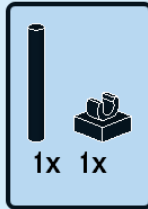

6

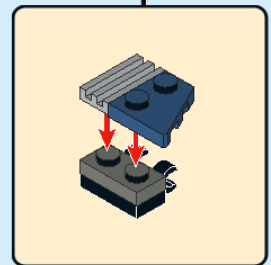
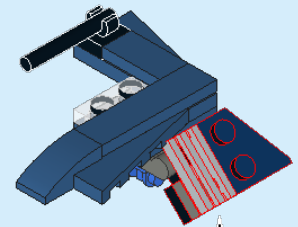
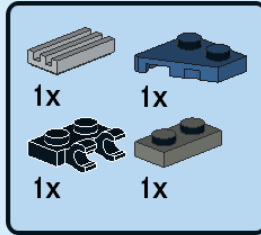

119

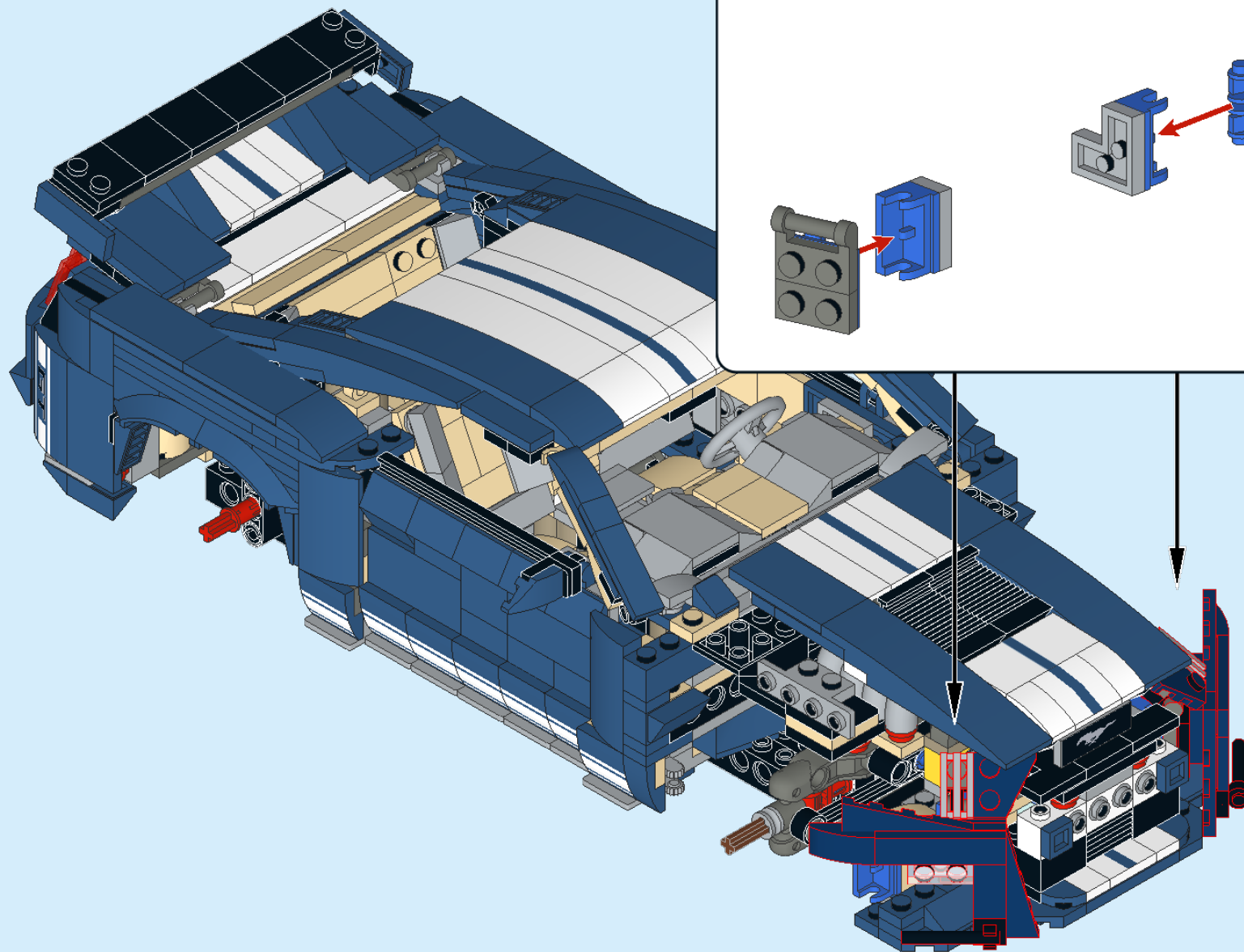

120

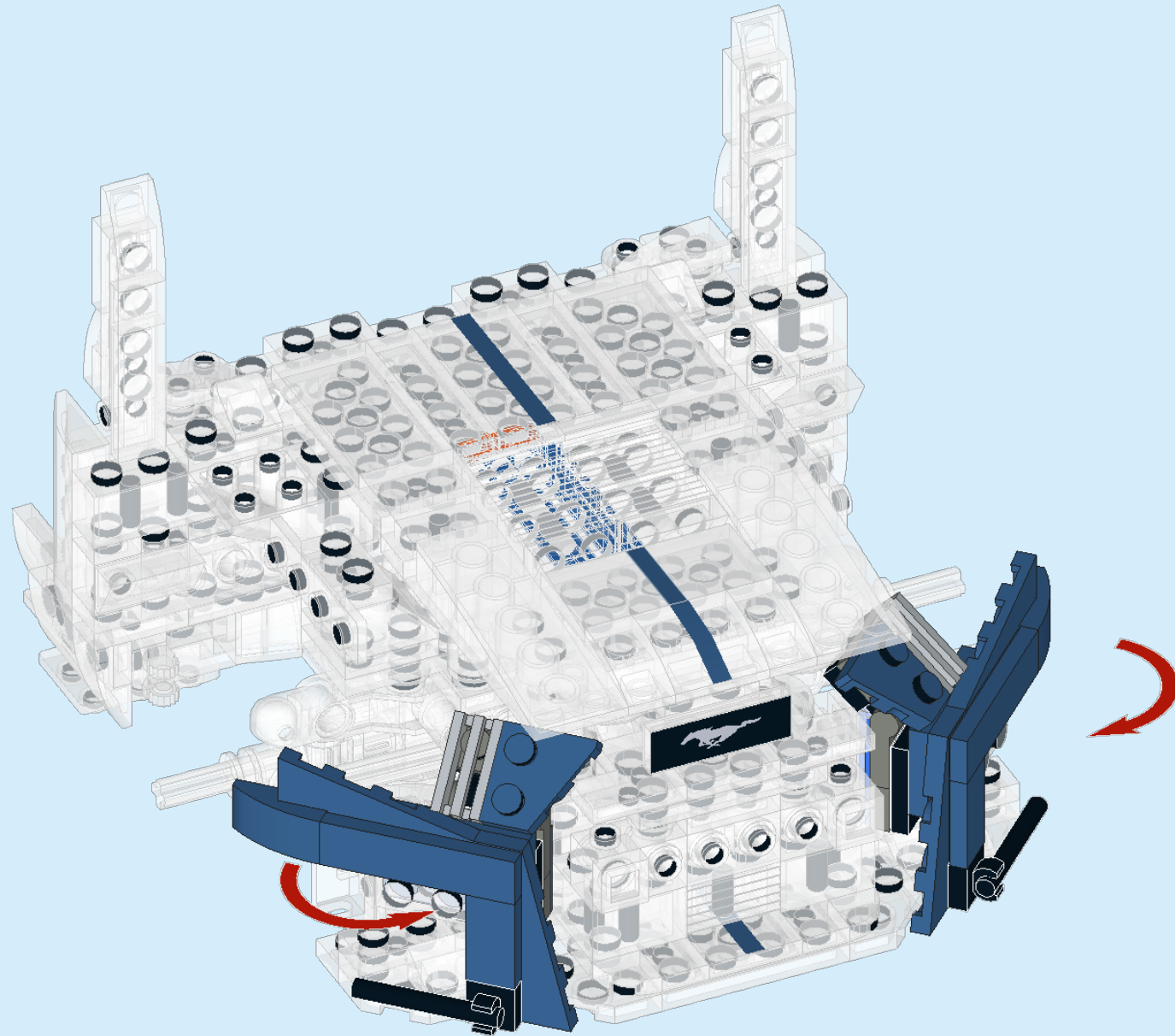

121

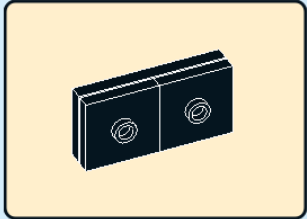
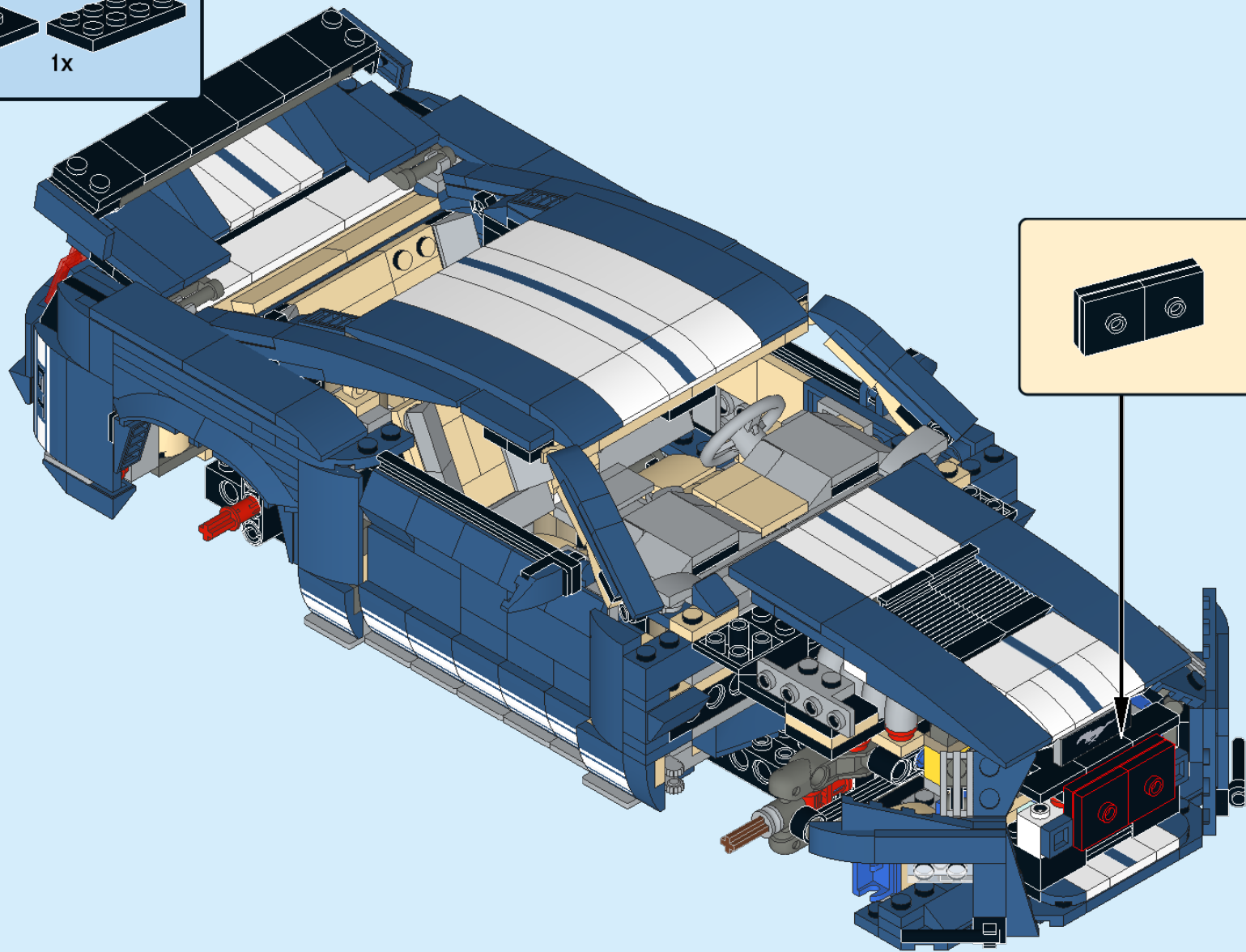
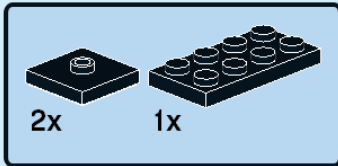

122

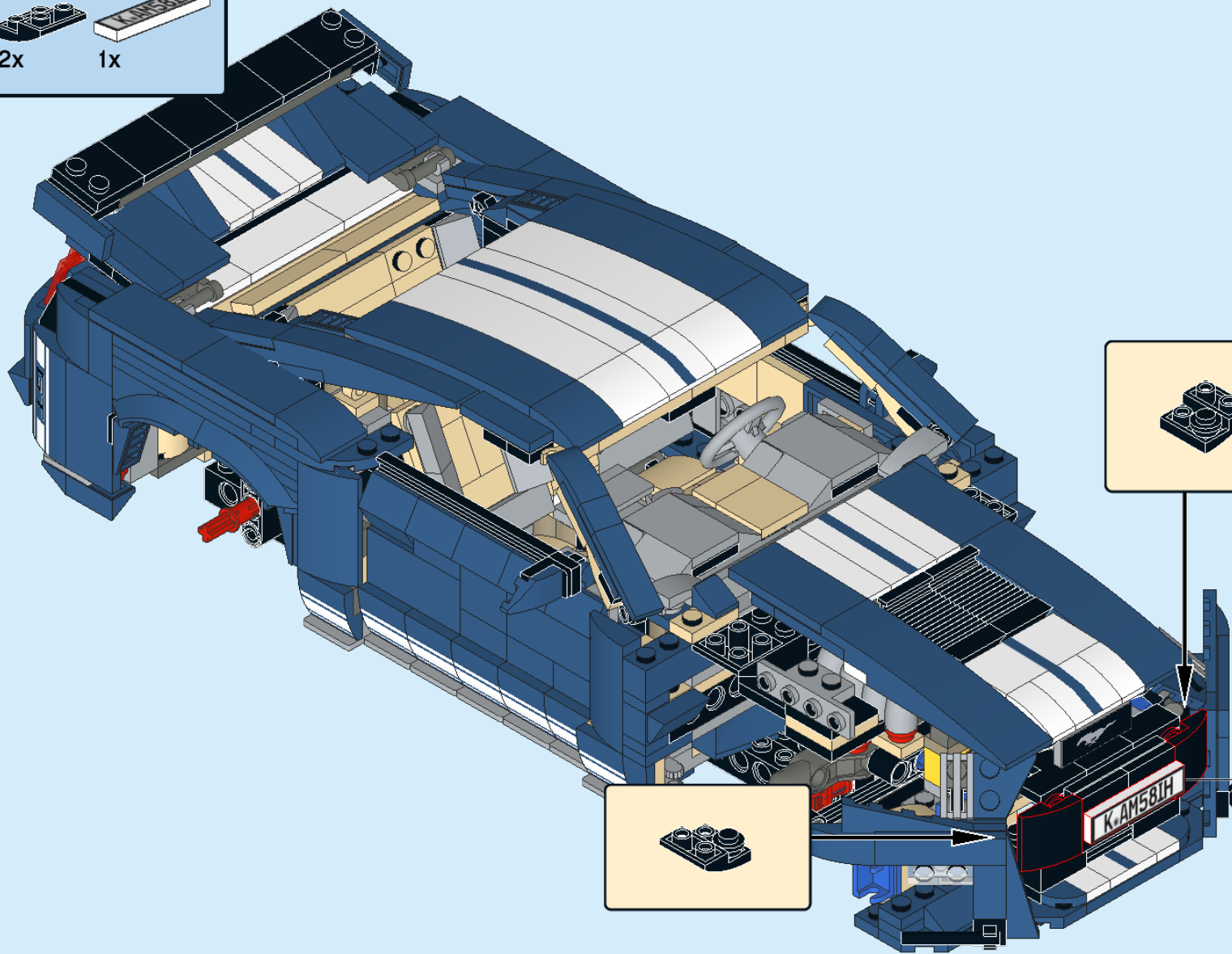
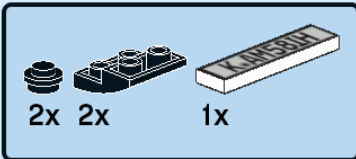

123

- 2x
- 2x
- 2x
- 2x
- 1x
- 1x
- 2x

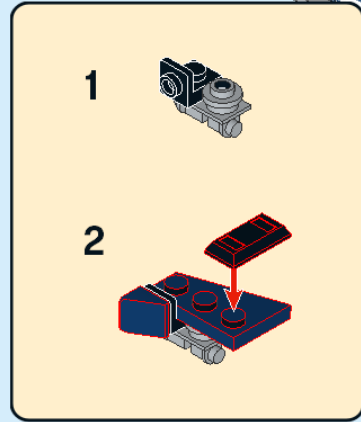
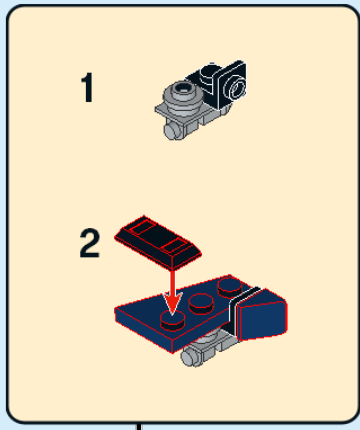
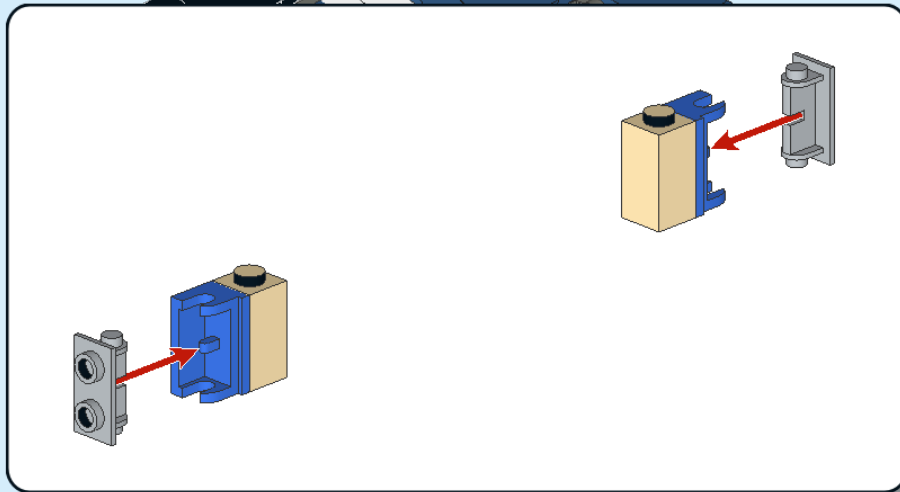

- 1
- 2

124

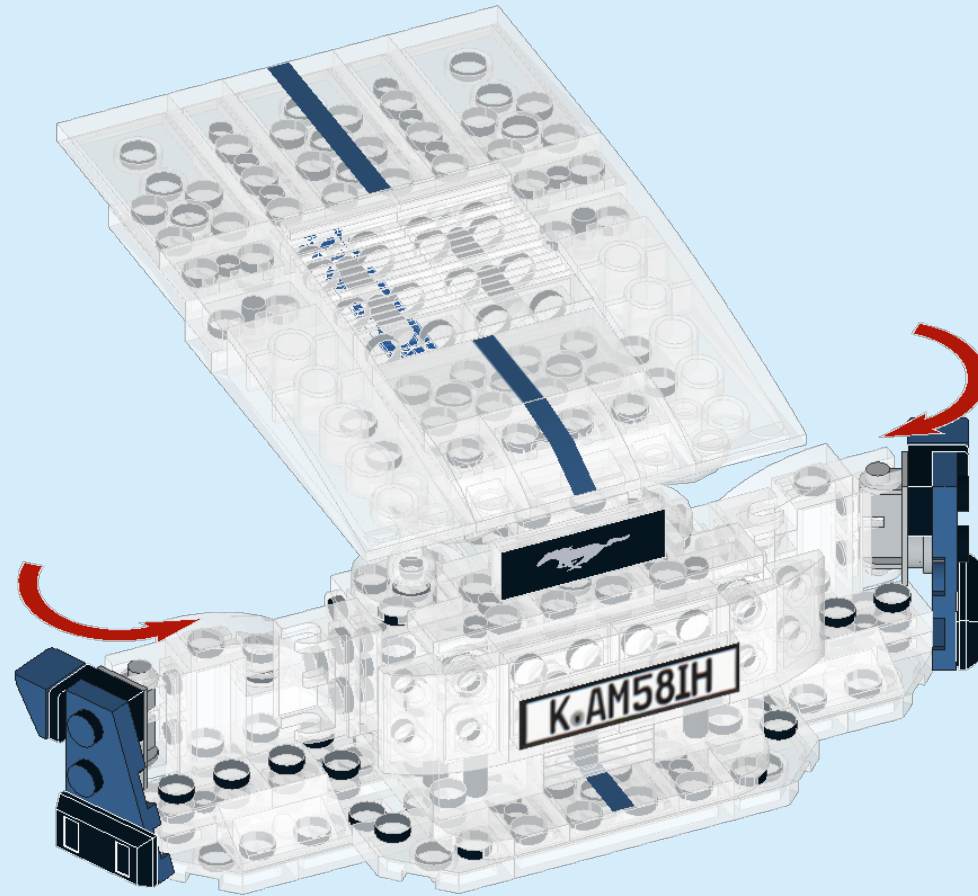

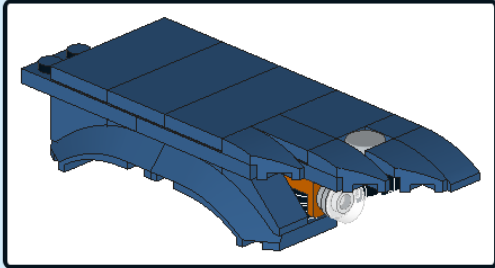

1

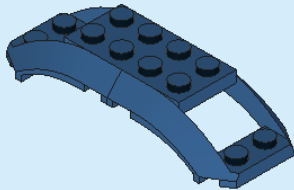
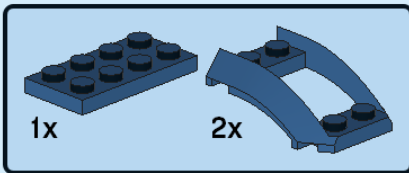

2

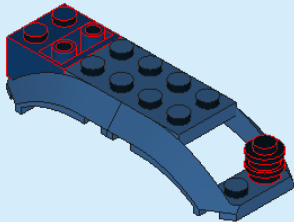

3

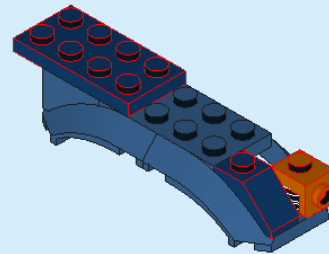
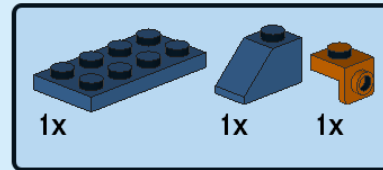

4

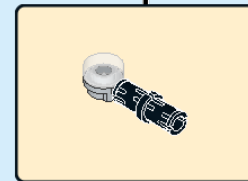
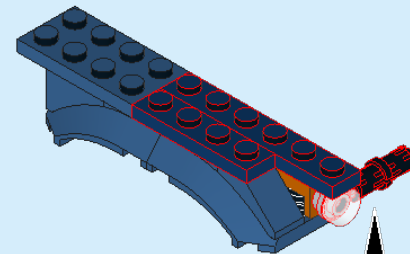
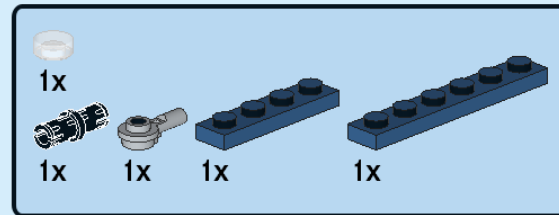

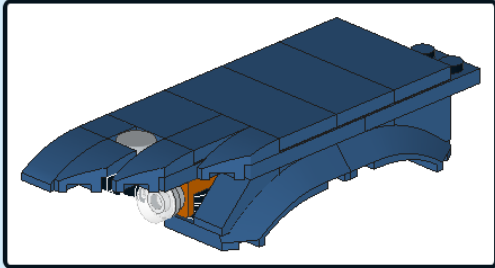

1

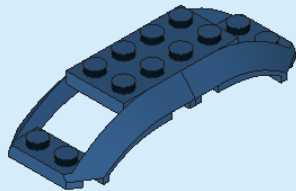
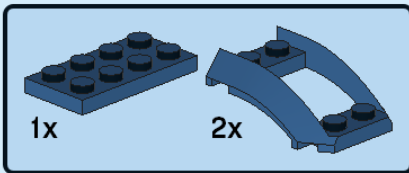

2

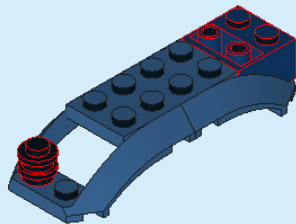

3

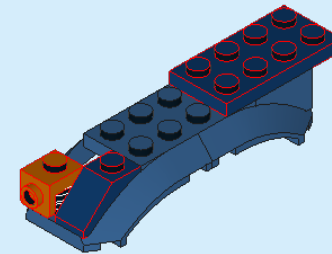
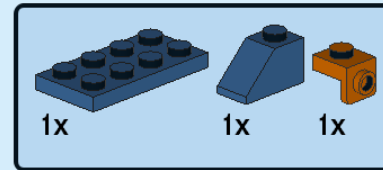

4

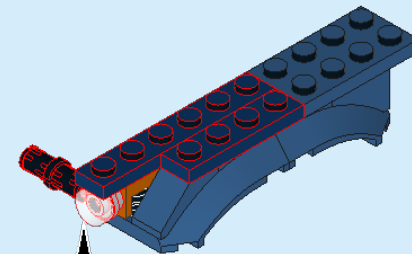
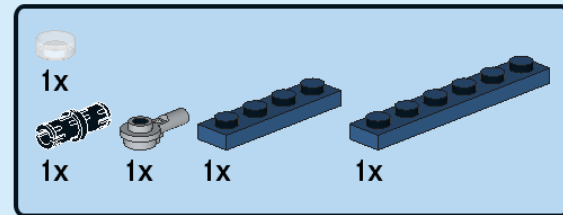

5

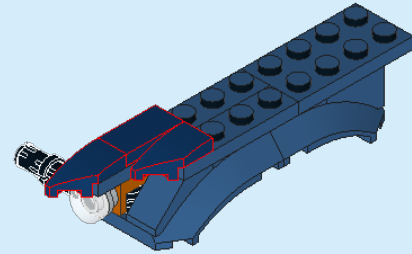
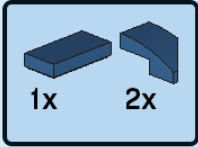

6

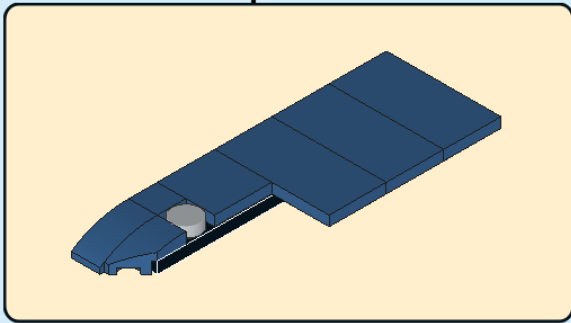
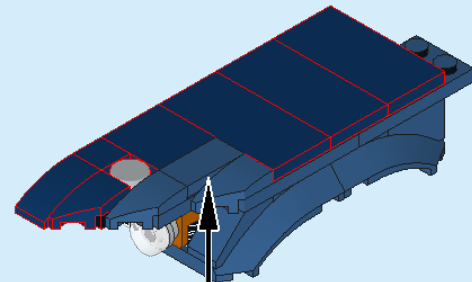
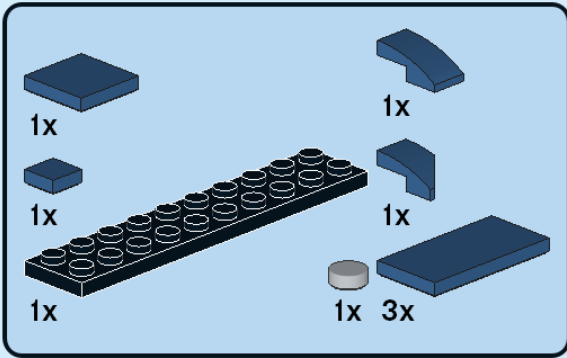

125

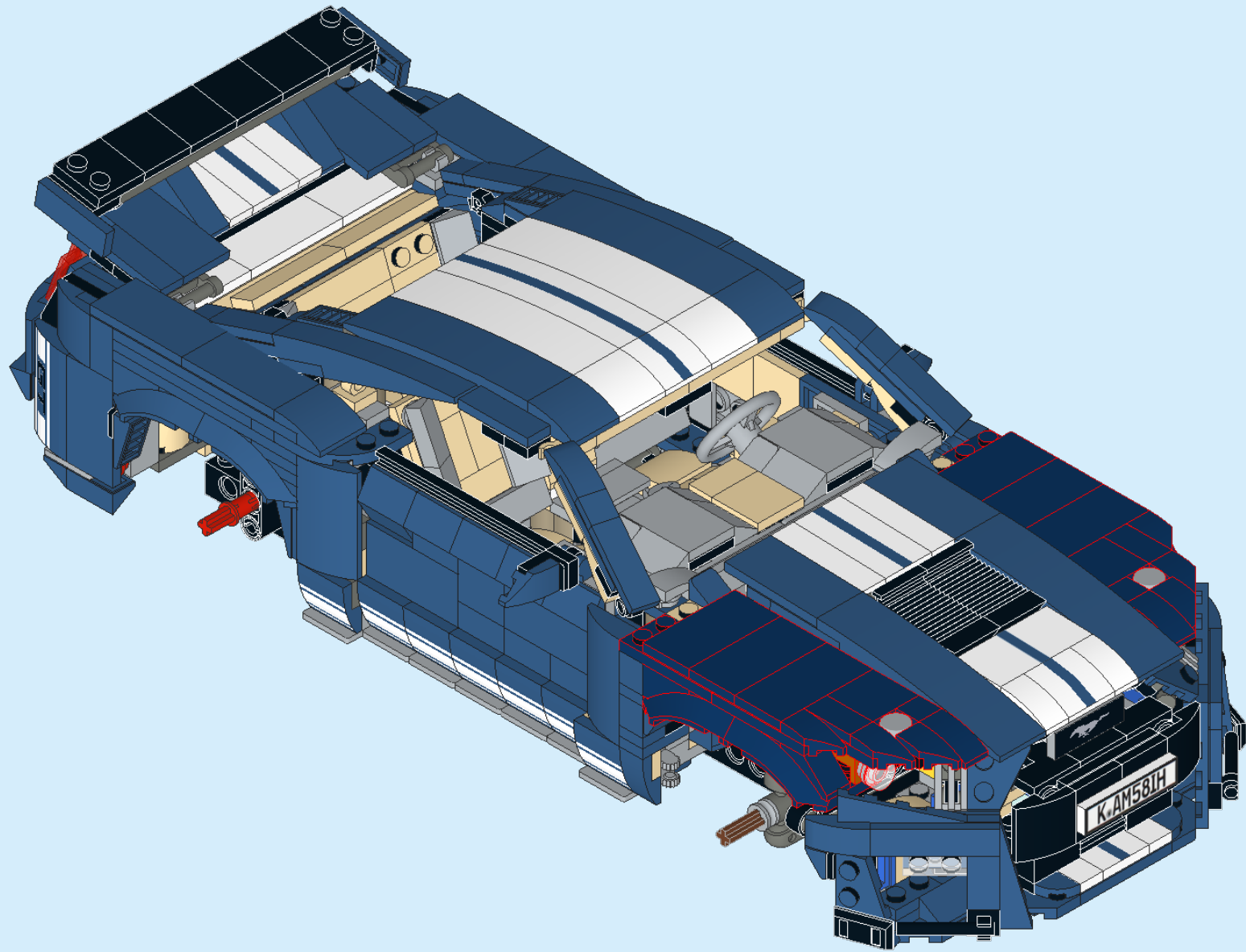

126

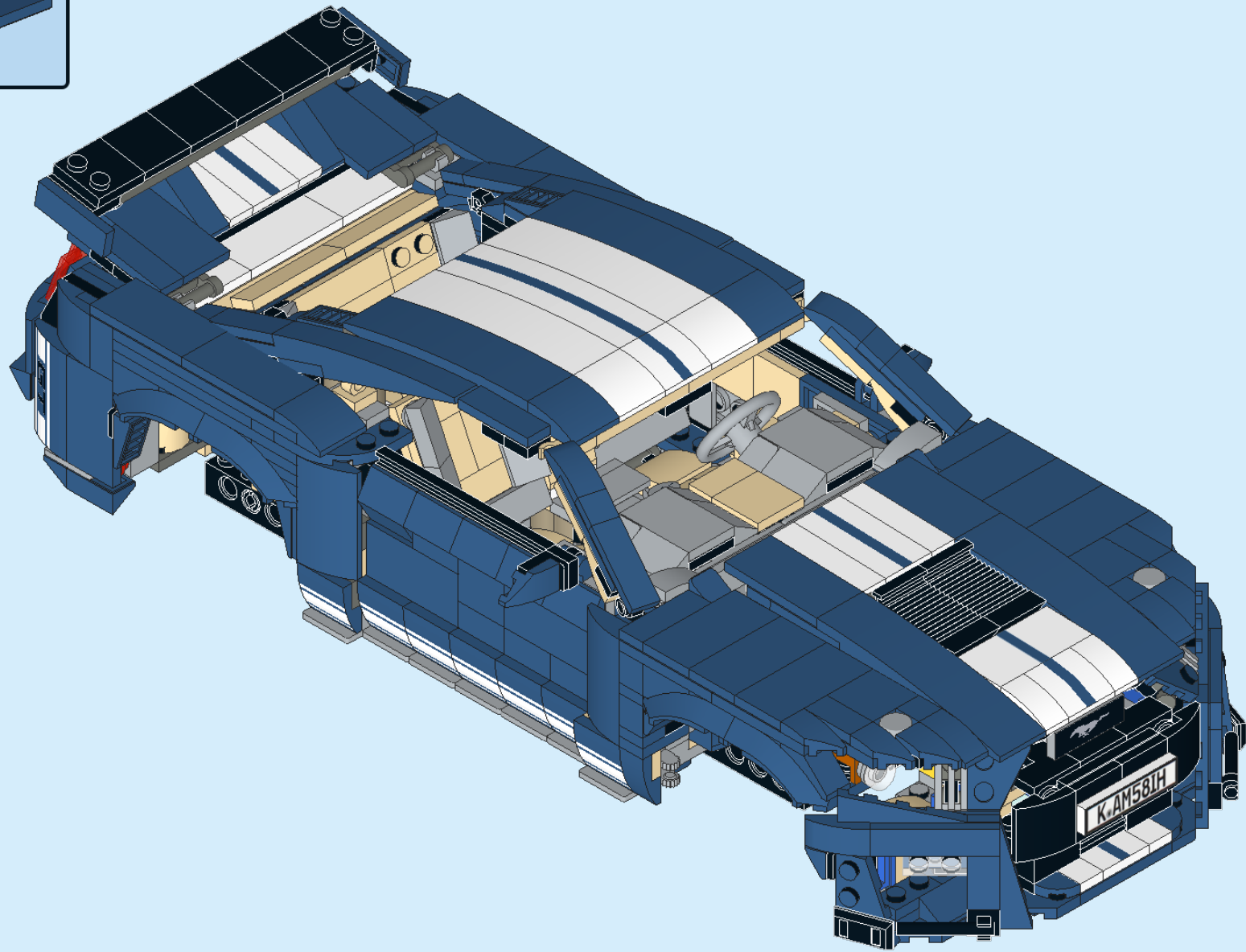
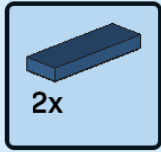

127

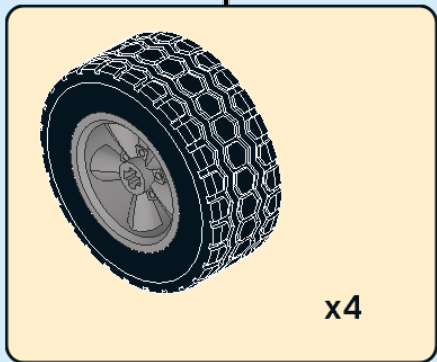
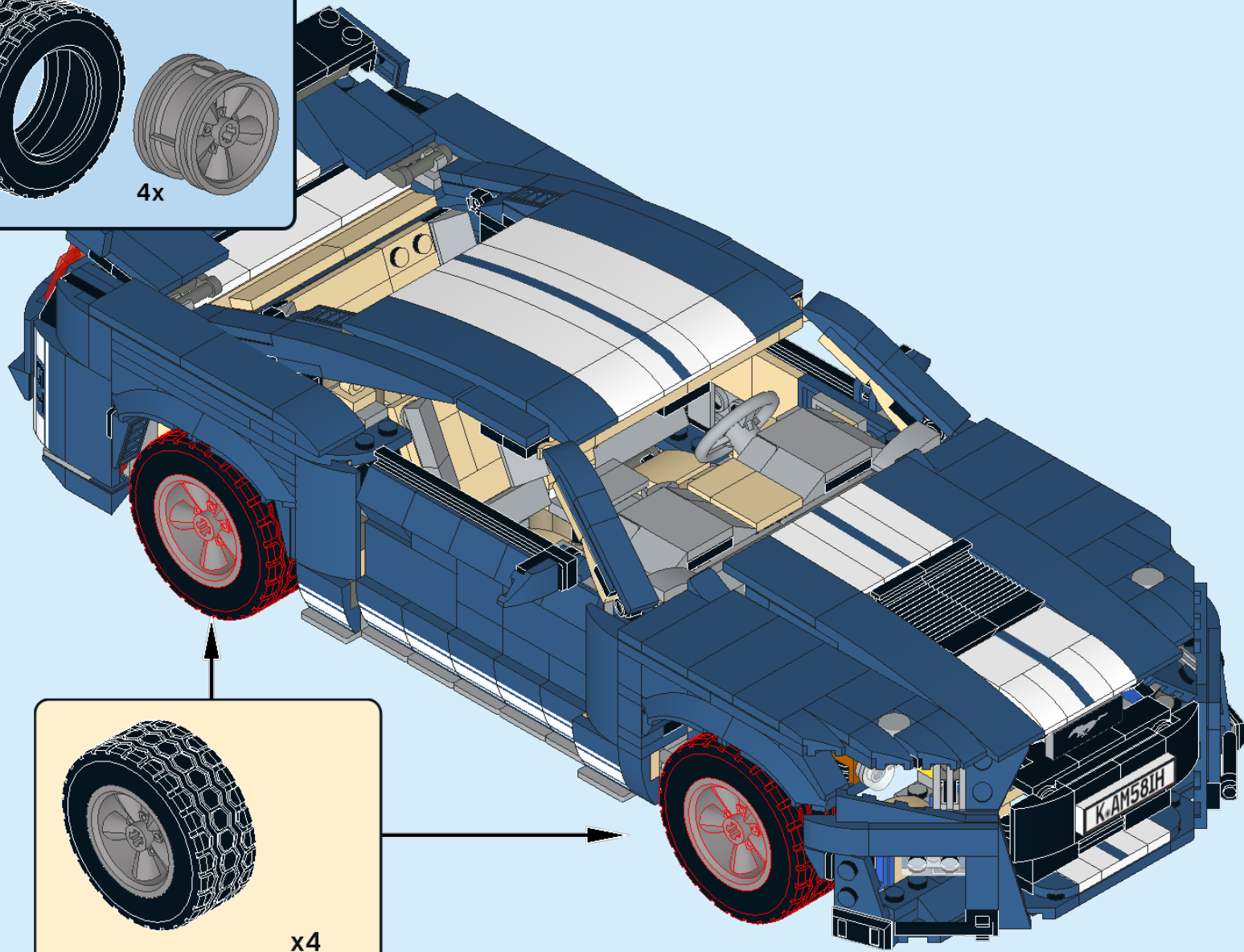
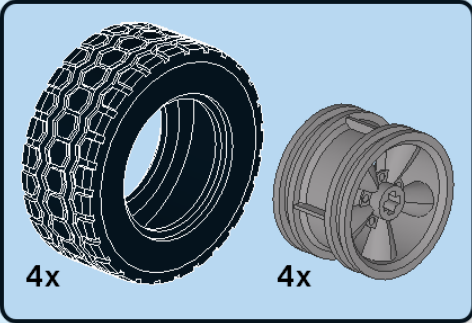

128

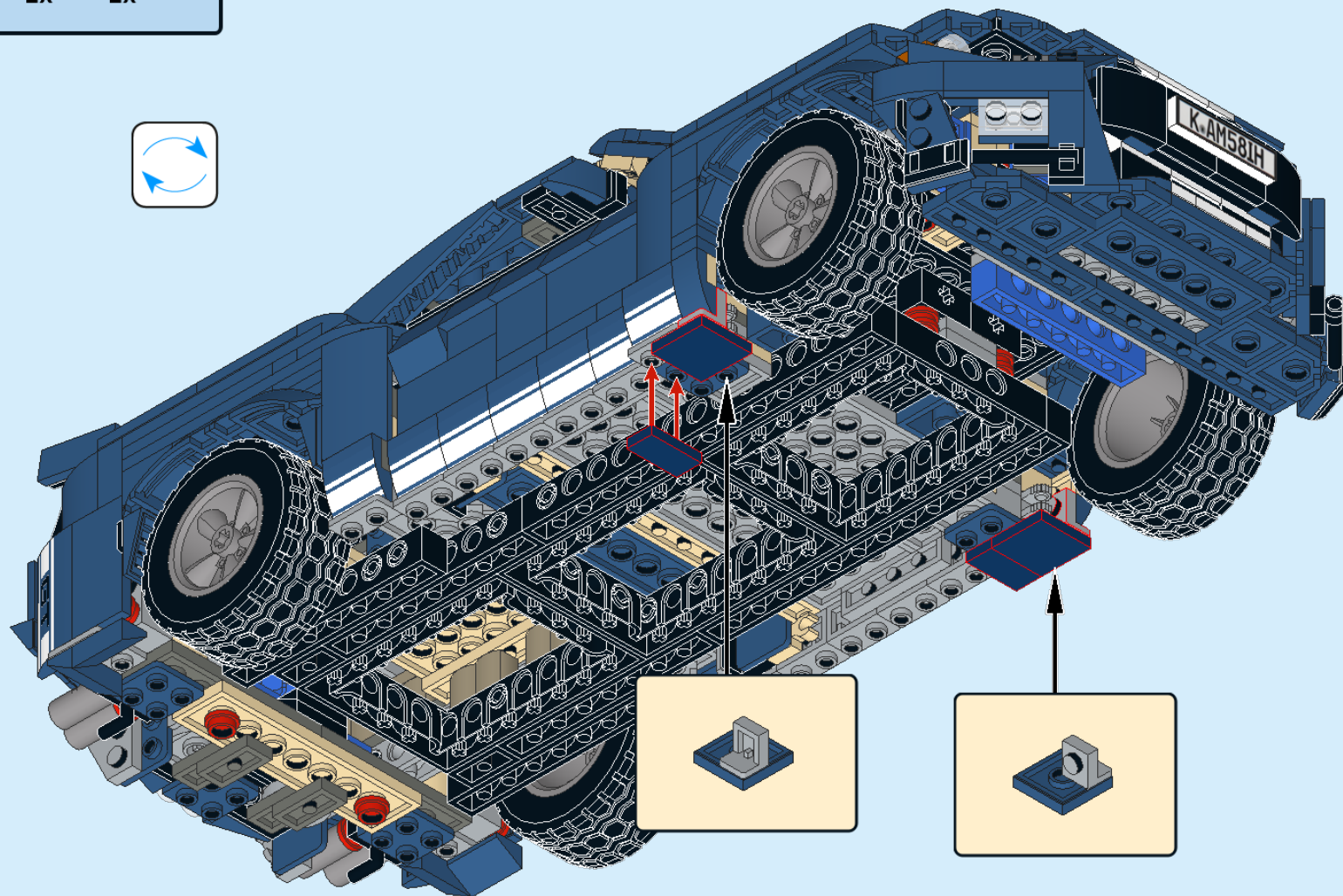
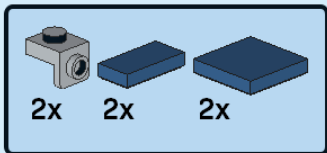

129

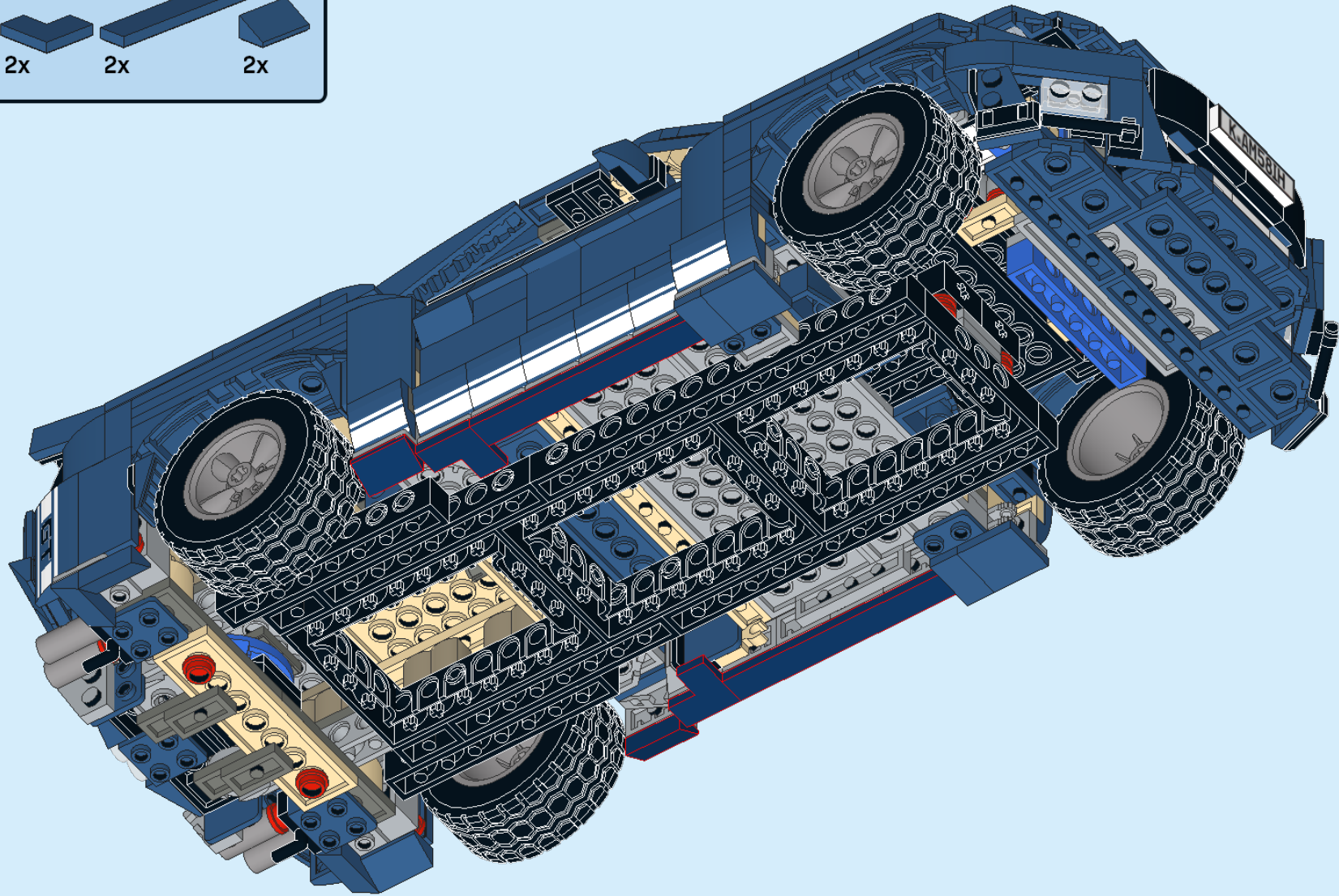
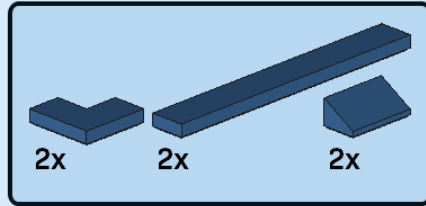

130

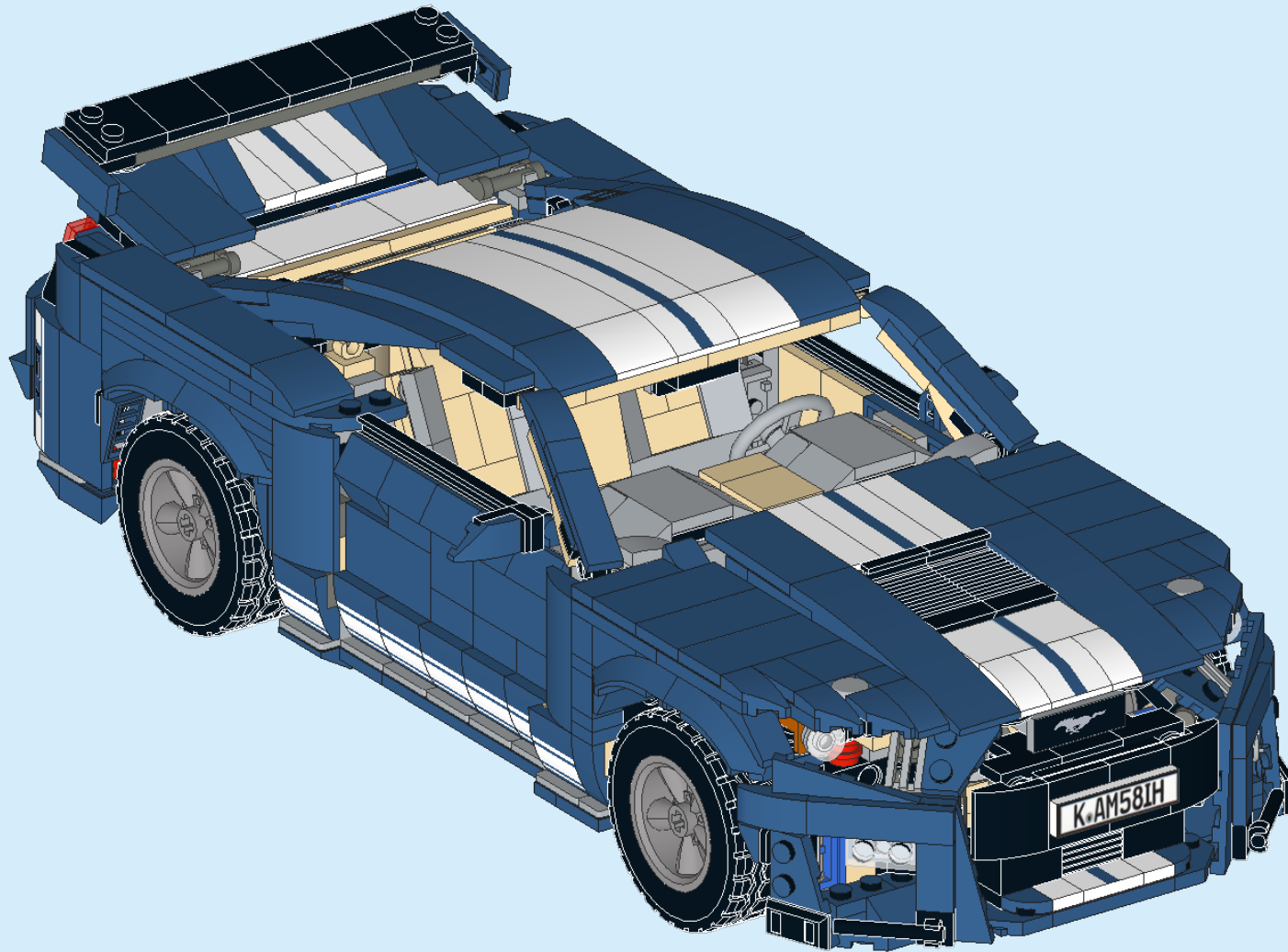



131

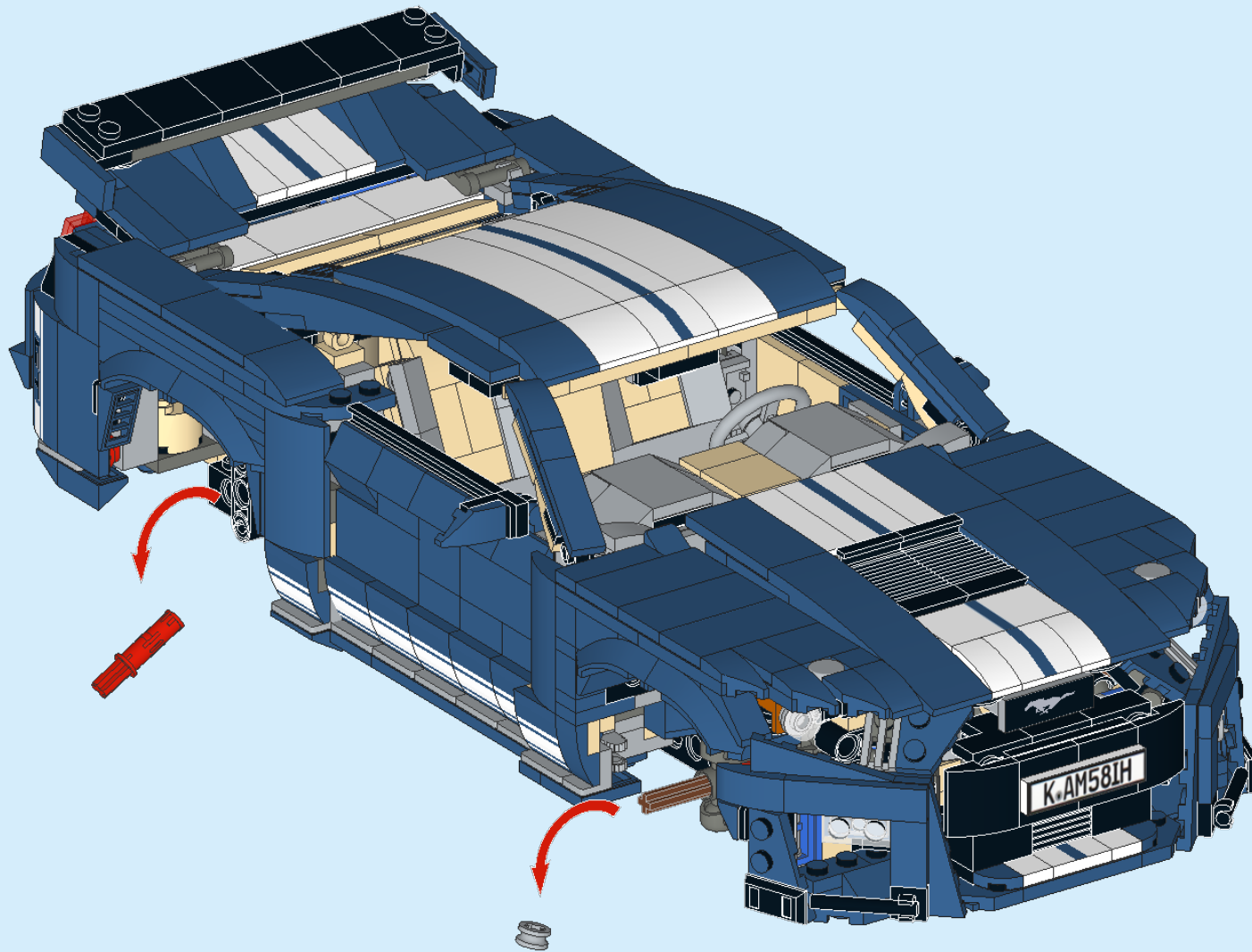

132

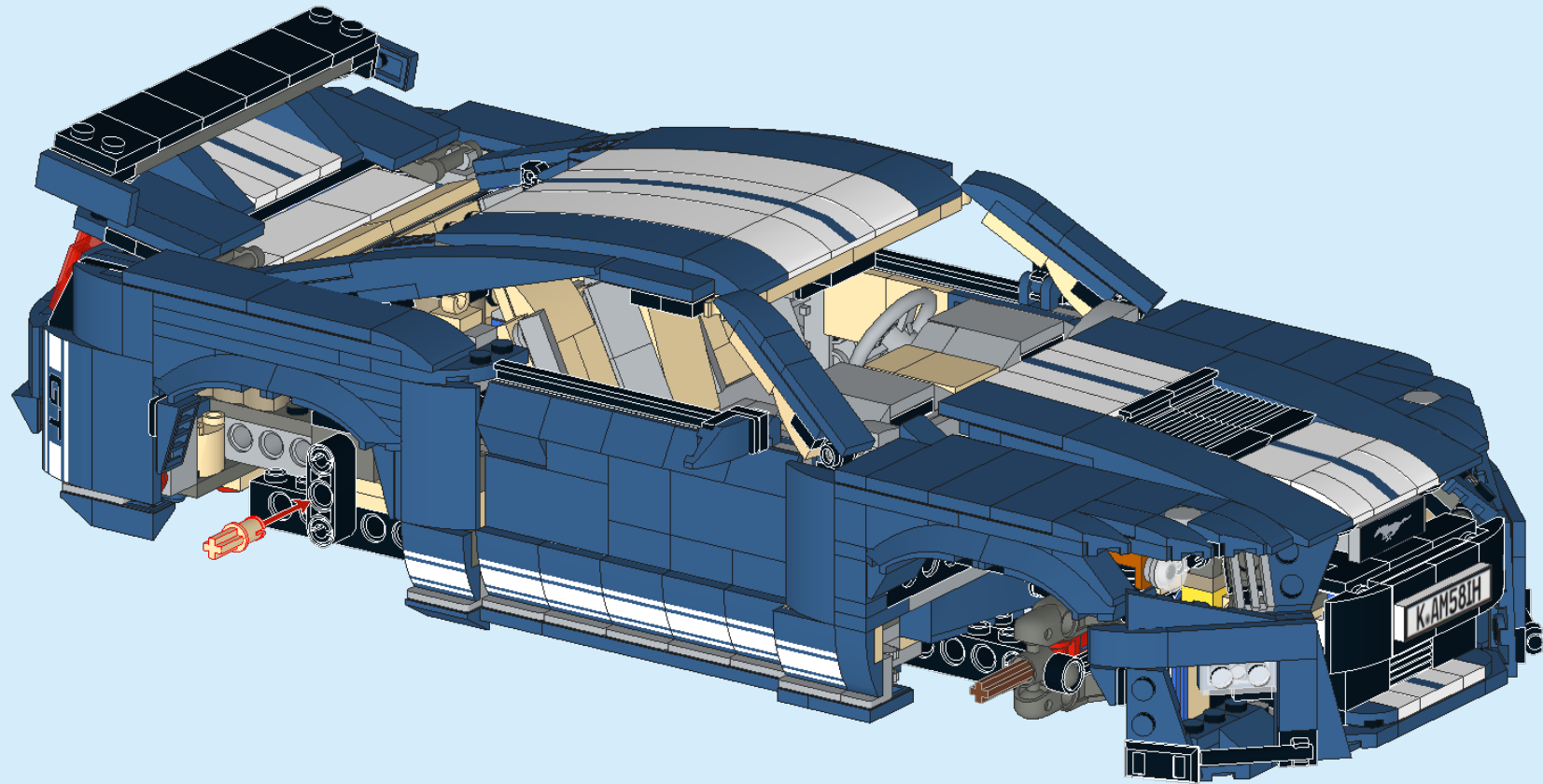
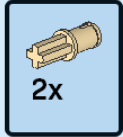

133

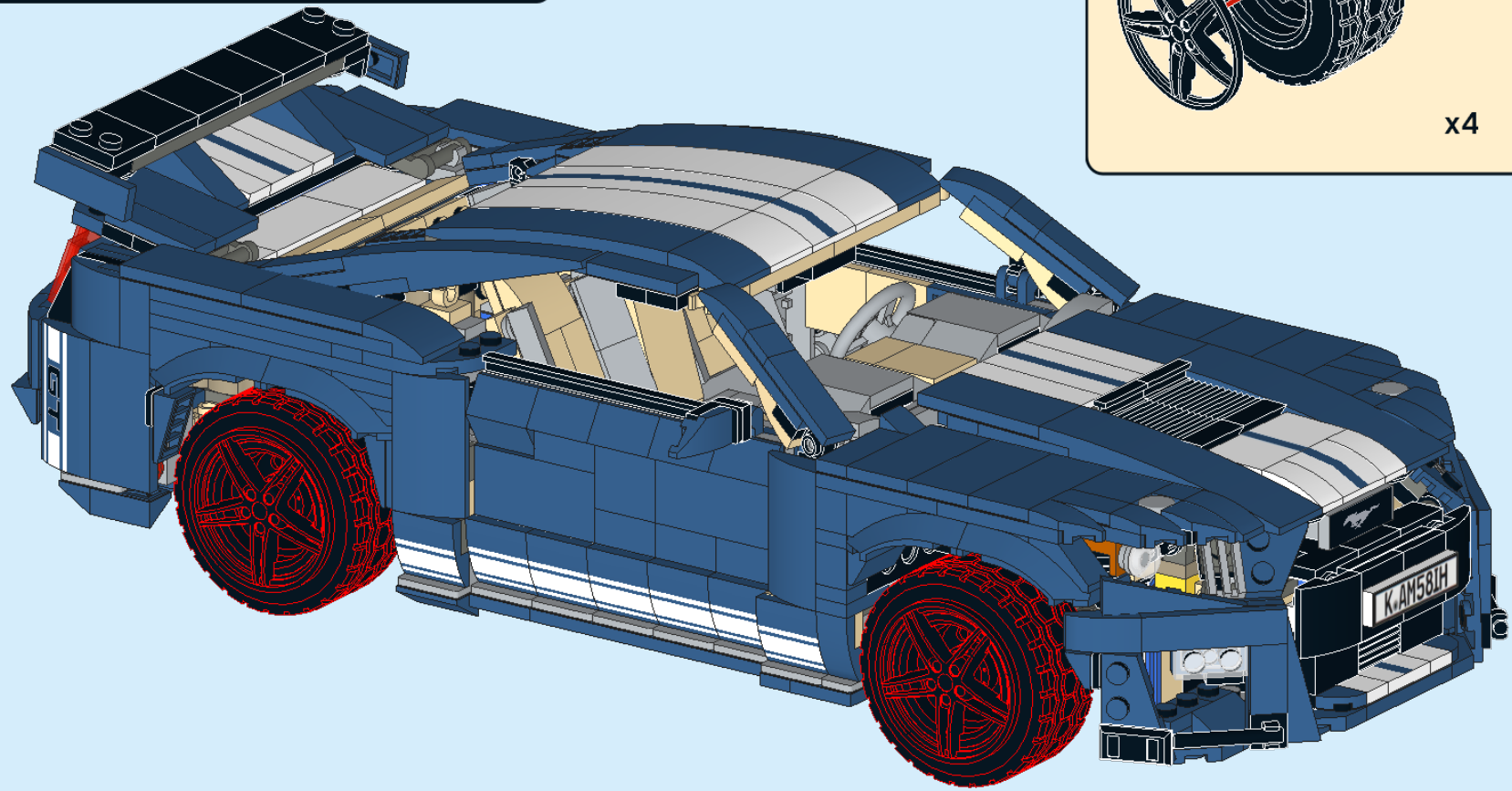
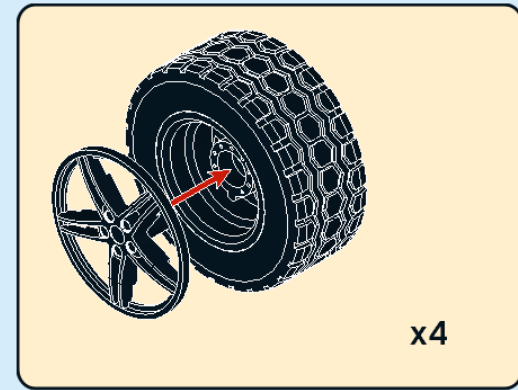
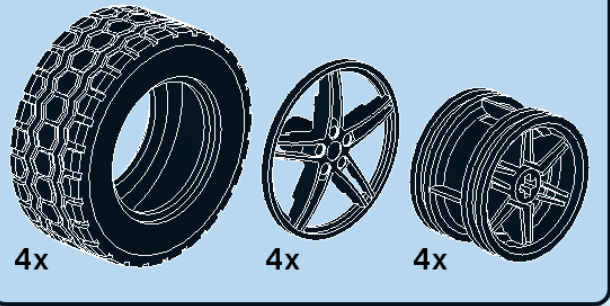

133

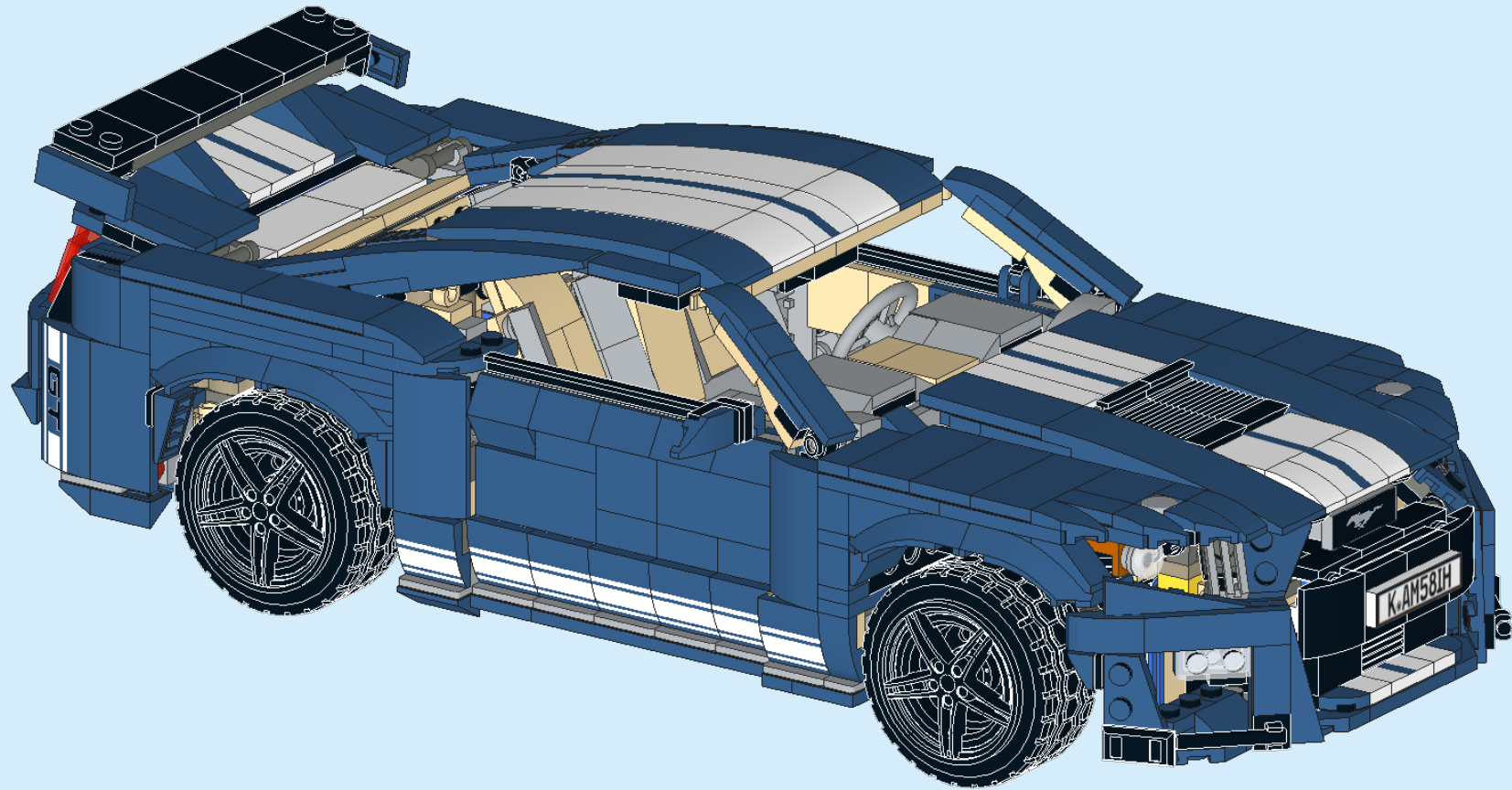

134

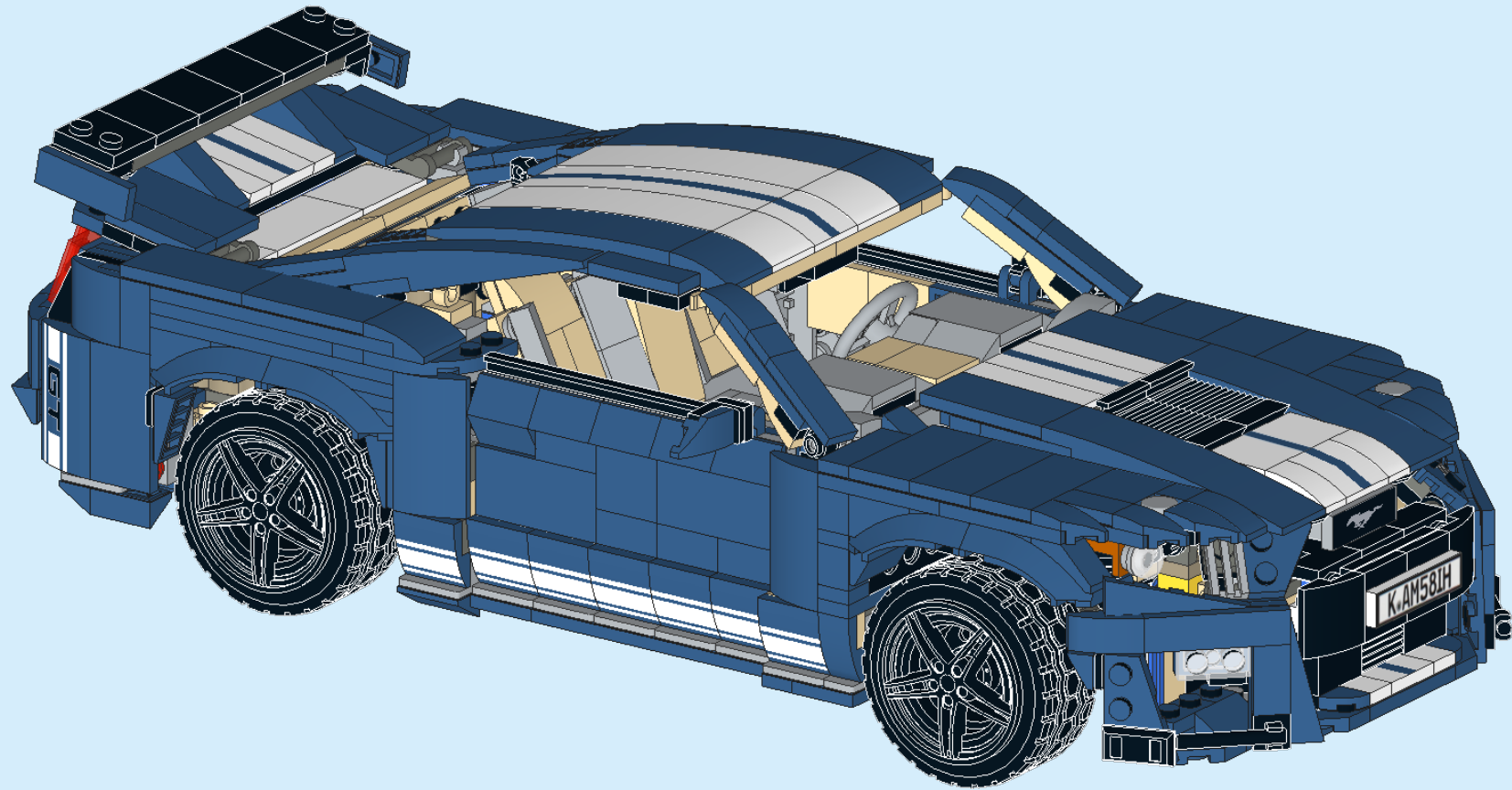

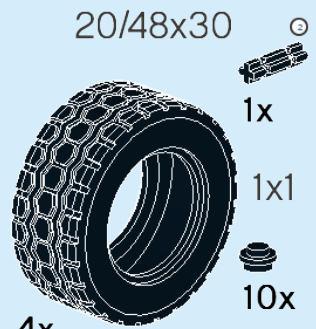

20/48x30

4x 2x3

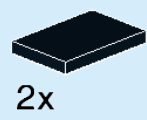

2x

2x2

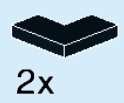

2x

1x2



2x

1x1



4x

3L



2x



1x

1x1



10x



2x



1x

1x

2x2

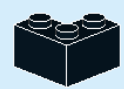

4x

1x2

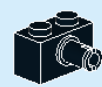

2x

1x2



5x



2x

1x2



2x

1x12

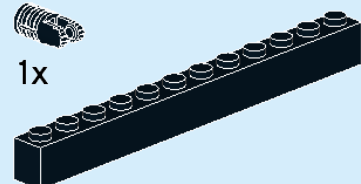

1x



4x

1x2



2x

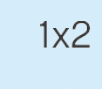

10x

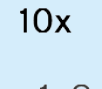

1x2

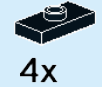

4x



2x



2x

3x



2x



4x

1x2



2x

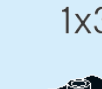

10x

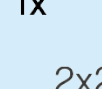

1x2



4x



2x

2x6

2x

3x6

1x



2x4



4x

1x3



6x



1x



2x2



2x



1x2



2x



2x

3x3x2



2x



4x1



1x

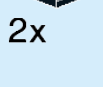

2x



2x



1x



4x



2x



2x

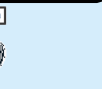

2x

333x2



2x



4x1

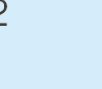

1x

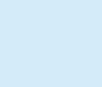

2x

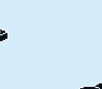

2x



1x



4x



2x

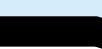

2x

1x3



2x



3x

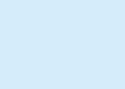

1x



1x

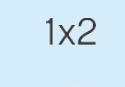

1x2

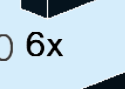

6x

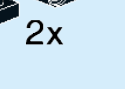

2x



5x

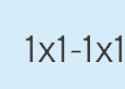

6x

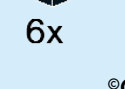

6x

6x8

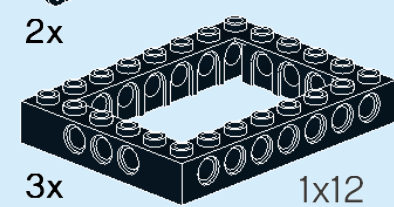

3x

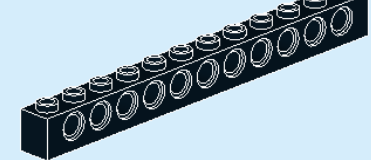

1x

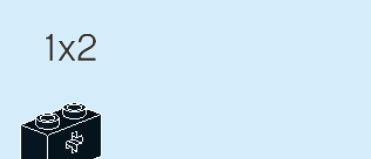

1x2

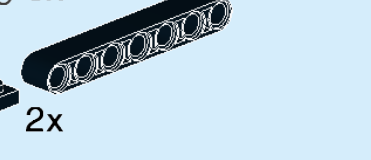

4x10

6x

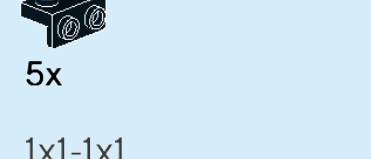

2x



1x2-1x2

5x

1x1-1x1

6x

6L

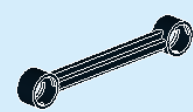

2x

1x2
6x 1x4

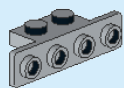
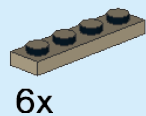

9x

2x2



1x

1x1



4x

1x1



3x



1x



2x

2x2



1x

1x2



2x

1x1



4x

1x1



10x

1x1



2x

4x

2x2

3x

2x2

2x2

3x

5x

2x3

2x

2x2

2x2

1x

2x2

1x

1x

2x2

7x

2x2

2x

1x1

4x

1x4x1

10x

3x3

2x

2x2

10x

1x2

2x2

1x2

3x

2x2

1x

3x



2x

2x2x0.667



4x



4x

1x4



10x

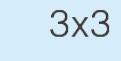

2x



2x2

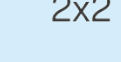

1x2

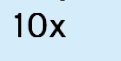

3x

1x2-1x2



14x

1x1-1x1

4x

31x1x0.667

4x12

4x

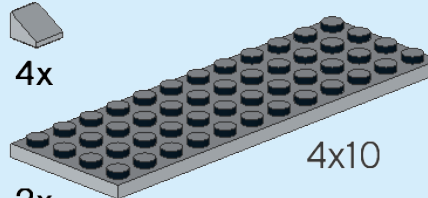

2x

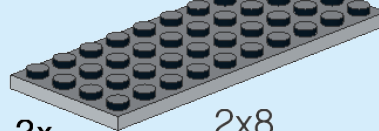

2x

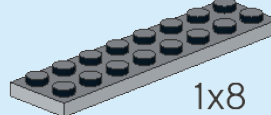

5x

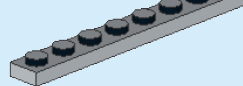

5x

4x10

4x

4x10

1x10

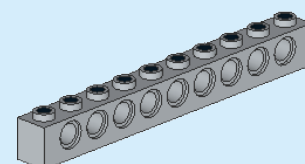

2x

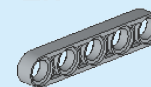

4x

1x2-2x2

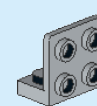

10x

2x2
2x



5x



311x2x0.667
19x



1x2
30x



2x4
1x

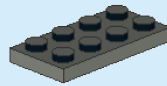

1x2
2x



1x2
10x



1x2



2x1
2x

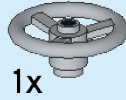

1x

1x2-2x4
2x

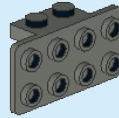

4x

1x2-2x2
17x

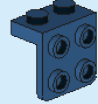

1x4
8x

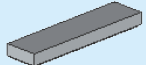

1x1
4x



2x12

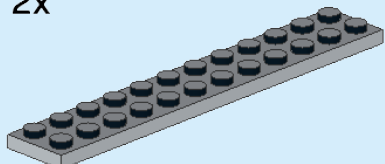

2x



2x2
3x

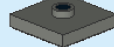

20x30

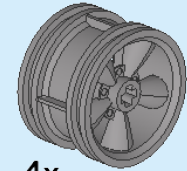

2x1
8x



1x2
6x



2x



3x3
2x

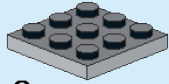

2x2
8x



1x2
10x



4x3
1x

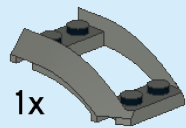

4x

1x8

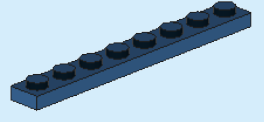

1x2
7x



1x2
4x



1x3
2x

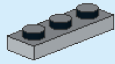

3x2x1.333
1x

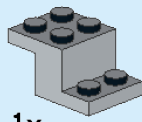

2x2
2x

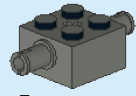

1x

1x10

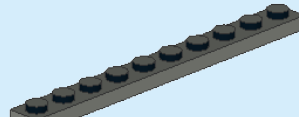

1x1
2x



2x6

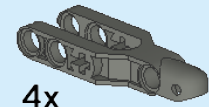

1x4
4x



1x1
2x



1x4

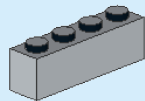

2x2
6x



2x2-1x2
1x

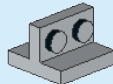

4x3x1
1x



6x
2x

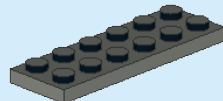

2x



1x4
4x



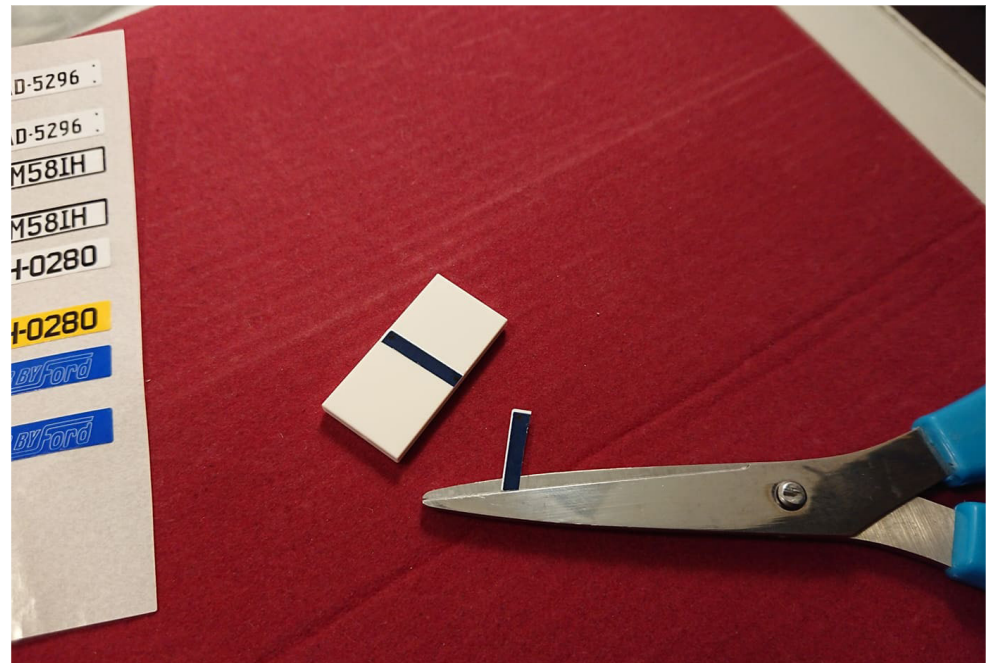
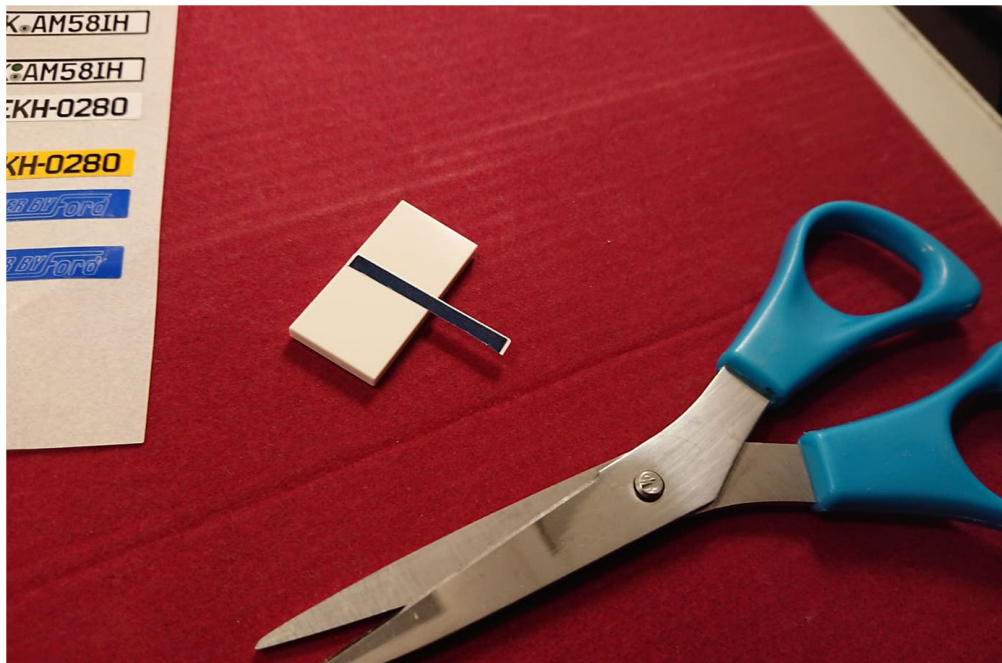
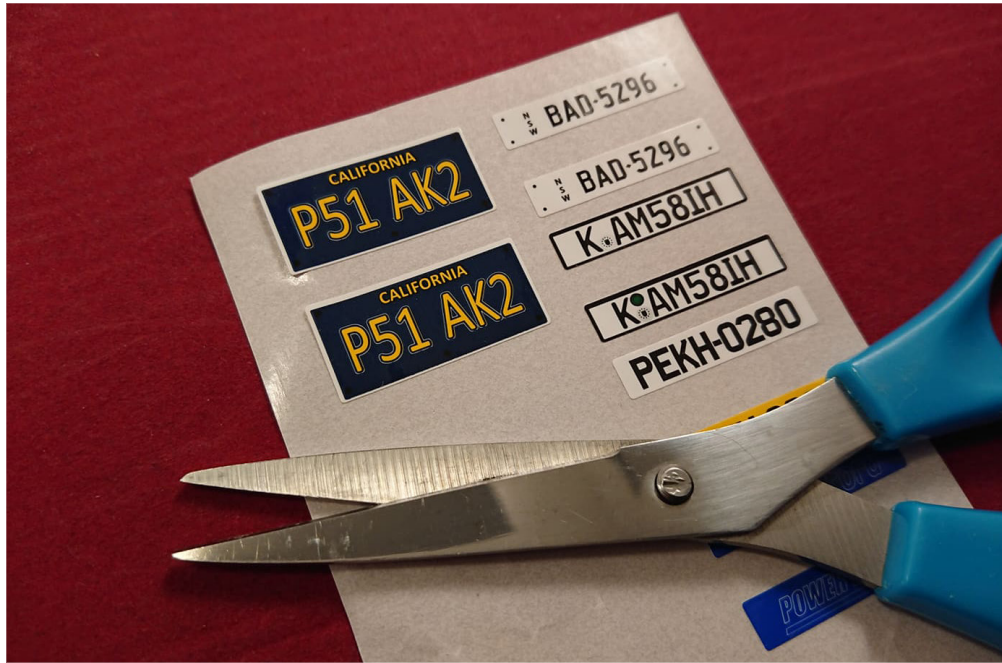

GALLERY



















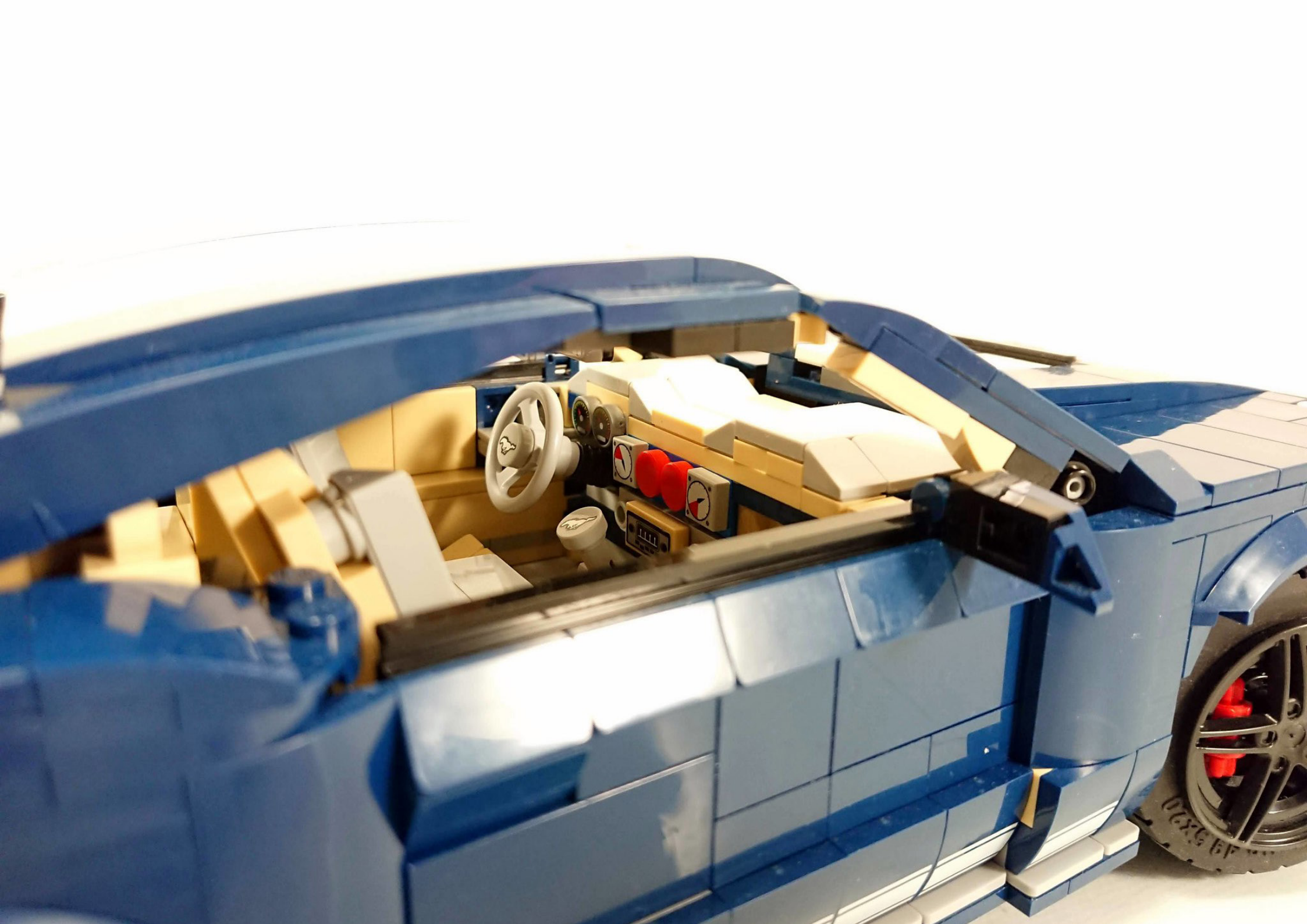





CONTACTS

Firas Abu-Jaber - MOC author



BRICKS GARAGE

by Firas Abu-Jaber

Store: www.bricksgarage.com

Flickr: [flickr.com/photos/31460192@N02/](https://www.flickr.com/photos/31460192@N02/)

Facebook: [facebook.com/LEGO-cars-by-Firas-Abu-Jaber-1387763391553093/](https://www.facebook.com/LEGO-cars-by-Firas-Abu-Jaber-1387763391553093/)

Instagram: [instagr.am/firas_legocars/](https://www.instagram.com/firas_legocars/)

Email: firaslegocars@gmail.com

Simone Bissi - Instuction booklet author **BISSI**

Facebook: [facebook.com/simonebissi](https://www.facebook.com/simonebissi)

Instagram: [instagr.am/simone.bissi](https://www.instagram.com/simone.bissi)

Twitter: twitter.com/simonebissi

Flickr: [flickr.com/photos/63192945@N07](https://www.flickr.com/photos/63192945@N07/)