









**L'acier, l'aluminium.** Travailler et exploiter toutes leurs possibilités pour concevoir du mobilier au design innovant, en répondant toujours à une vraie fonctionnalité, tel est notre leitmotiv. Avec , l'acier prend forme, se transforme, devient matière à idées... pour vous étonner, vous amuser, vous séduire. Innover pour rendre la vie plus belle, plus simple. Jouer des formes et des couleurs. Avoir matière à se faire plaisir... Nos créations s'intègrent dedans, dehors, et vous permettent de composer selon vos besoins, avec les différentes combinaisons possibles de formats, de coloris et de finitions.  libère vos envies en inventant un mobilier qui vous ressemble, d'une qualité irréprochable, résistant aux intempéries et facile à monter.

**L'usine.**  mise avant tout sur la qualité des produits et la maîtrise des process de fabrication. Elle dispose de sa propre unité de production près de Lyon. Le design est confié depuis la création de la marque à des designers de renom ou en devenir.

**Notre crédo.** Apporter joie de vivre, couleurs, gaîté dans vos aménagements et combiner notre créativité à notre savoir-faire pour vous proposer des produits originaux, exclusifs, durables, nouveaux!



**Steel, aluminium.** To explore and utilise all means possible in the design of innovative furniture, where form follows function, that is our motto. With , steel takes shape, transforms, and becomes the physical expression of our ideas... to surprise you, delight you, and seduce you. Innovation makes the world more beautiful and yet more simple. The interplay of shape and colour.  creations are not just furniture, but works of art. Our designs are crafted for both interior and outdoor environments, with a range of specialist materials available according to your needs and requests, in a variety of size, colour and finish combinations.  frees your desires by inventing furniture that reflects your personality, is of the highest quality, is weather resistant and is easy to assemble.

**The Workshop.** 's highest priority is product quality, through strict control of the manufacturing process. Our production facility is located just outside of Lyon, France. All of our designs have been created exclusively for  by a variety of renowned artists and emerging talents.



**Our Philosophy.** We bring the joys of life, colour, and style into your world, combining our creativity and expertise to offer you original, exclusive, durable, inventive, and innovative products to inspire you for years to come.

made  
in France

Nos produits sont fabriqués en :

-  **Acier** Usage intérieur uniquement.
-  **Aluminium** Usage intérieur et extérieur. Obligatoire pour le bord de mer.
-  **Acier galvanisé** Usage intérieur et extérieur. Ne convient pas pour le bord de mer.

Our products are manufactured in:

-  **Steel** Only for indoor use.
-  **Aluminium** For indoor & outdoor use. Strictly recommended for outdoor use, especially for the seaside.
-  **Galvanized steel** For indoor & outdoor use. Not suitable for the seaside.



Toutes les dimensions données dans le catalogue sont en cm.  
All dimensions given in the catalog are in cm.

L. Longueur Length  
P. Profondeur Depth  
H. Hauteur Height





**Couleurs | Colors**  
Notre mobilier est disponible dans tous les coloris ci-dessus à l'exception des finitions Brut vernis brillant n°20 et Brut vernis mat n°28. Veuillez vous référer au cahier technique.

*Our furniture is available in all the listed colors except Gloss varnish steel 20 and Matt varnish galva 28. Please refer to our technical guide.*

- |                                    |                                                 |                                           |
|------------------------------------|-------------------------------------------------|-------------------------------------------|
| 01. Blanc   White                  | 12. Rouge   Red                                 | 23. Craie   Grey white                    |
| 02. Gris   Grey                    | 13. Orange   Orange                             | 24. Rose clair   Light pink               |
| 03. Noir pailleté<br>Glitter black | 14. Jaune   Yellow                              | 25. Vieux rose   Old pink                 |
| 04. Anthracite   Anthracite        | 15. Vert anis<br>Anise green                    | 26. Rouge pourpre<br>Purple-red           |
| 05. Bleu canard<br>Ocean blue      | 16. Kaki   Khaki                                | 27. Jaune soufre<br>Yellow sulphur        |
| 06. Céladon   Celadon              | 17. Taupe   Beige                               | 28. Brut vernis mat<br>Matt varnish galva |
| 07. Bleu   Blue                    | 18. Sable   Sand                                | 29. Cuivre   Copper                       |
| 08. Aubergine   Eggplant           | 19. Marron   Chestnut                           | 30. Or   Gold                             |
| 09. Vert mousse<br>Moss green      | 20. Brut vernis brillant<br>Gloss varnish steel |                                           |
| 10. Violine   Purple               | 21. Bleu pigeon<br>Pigeon blue                  |                                           |
| 11. Rose vif   Pink                | 22. Gris bleu   Blue-gray                       |                                           |

**Légendes des pictogrammes  
Pictograms**

- 🏠 Usage exclusif à l'intérieur.  
*Only for indoor use.*
- ⚙️ Produit à monter. Visserie et clés de montage fournies.  
*Product to assemble. Screws and allen key provided.*
- 🔧 Usage possible à l'extérieur.  
*Possibility to use outdoor.*
- 📦 Possibilité d'intégrer un tiroir dans le plateau.  
*Possibility to integrate a drawer.*
- 📦 Pied droit.  
*Straight legs.*
- 📦 Pied effilé.  
*Tapered legs.*
- 📦 Modèle empilable.  
*Stacking model.*
- 📦 Modèle pliable.  
*Folding model.*
- 🔹 Finition brut vernis brillant disponible.  
*Gloss varnish steel available.*
- 🔹 Finition brut vernis mat disponible.  
*Matt varnish galva available.*



# Designers



**Luc Jozancy**  
avantpremiere.fr

Accompagne la marque depuis ses débuts et est à l'origine de la création des gammes Zef, Hegoa, et des tables basses Galets dont le succès ne se dément pas depuis dix ans!  
**Formation:** ESAG Penninghen, Beaux-Arts de Bourges, Ensad Paris (1985) — designer industriel.  
**Expérience:** Agence Solus où il travaille pour Danone, YSL, Nathan, Plastic Omnium. Création du studio Avant Première en 1988, au sein duquel il est directeur du département design produit.  
**Références:** Groupe Seb, Dynastar, Alstom, Boiron... ainsi que ☺ depuis 2005!  
**Récompenses récentes:** En 2013, Good Design Award, Japon pour Tefal. En 2009, Étoile de l'observateur du design pour Effia, vélos en libre-service et Refurbishment of the Year pour la rénovation intérieure du TGV Thalys.

*Luc Jozancy assists ☺ since its creation and designed the Zef, Hegoa collection, also the Galets low tables whose success continues for 10 years!*  
**Education:** ESAG Penninghen, Beaux Arts de Bourges and Ensad Paris (1985) — Industrial designer Diploma.  
**Career:** Agency Solus working with companies from vastly different fields, among them Danone, Yves Saint Laurent, Nathan and Plastic Omnium. Creation of the Avant-Première design studio in Lyon in 1988, working as the head of the product Design department.  
**References:** Groupe Seb, Dynastar, Alstom, Boiron... and ☺ since 2005!  
**Awards:** In 2013, Good Design Award, Japan for Tefal. In 2009, Étoile de l'observateur du design pour Effia, Bikes and Refurbishment of the year for TGV thalys interior renovation.



**Constance Guisset**  
constanceguisset.com

**Formation:** ESSEC, IEP Paris, un an au parlement de Tokyo, ENSCI — Les Ateliers.  
**Expérience:** création du Studio Constance Guisset en 2007. Son travail s'articule autour d'une réflexion sur l'illusion visuelle et la surprise. Elle crée des objets légers, animés, dont l'élégante fluidité peut susciter l'étonnement et provoquer un instant d'évasion par le rêve.  
**Références:** Petite friture, Le Via, Molteni, Moustache, Louis Vuitton Malletier, Pallucco, Nodus, Fontana Arte, Groupe Accor...  
**Récompenses:** Grand prix de design de la ville de Paris en 2008. Prix du public à la Design Parade de la Villa Noailles en 2009. Créateur de l'année Now! design à vivre et Audi talent Awards en 2010. Janus du mobilier en 2014 pour la table Ankara fabriquée par ☺.

**Education:** Business and economics at ESSEC and IEP Paris, a year at the parliament of Tokyo, Diploma ENSCI — Les Ateliers. Constance Guisset set up her own studio in 2007. Her work revolves around a philosophy of visual illusion and surprise. She creates light, lively objects whose elegant fluidity may arouse a feeling of surprise and be a springboard for a moment's daydreaming.  
**References:** Petite Friture, Le Via, Molteni, Moustache, Louis Vuitton Malletier, Pallucco, Nodus, Fontana Arte, Groupe Accor...  
**Awards:** Grand Prix de Design de la Ville de Paris in 2008. The Public Prize at the Design Parade, Villa Noailles in 2009. The title of Designer of the Year at the Now! Design à Vivre and Audi Talents Awards in 2010. Janus de l'industrie 2014 for the Ankara collection manufactured by ☺.



**Rémi Casado**  
remicasado.com

**Formation:** BTS design produit Lycée Honoré d'Urfé de Saint-Étienne.  
**Expérience:** tout jeune designer, Rémi reste très ouvert à tous types de projets et passe avec brio du graphisme au design produit et à l'évènementiel. Ses dernières expériences récentes en sont la meilleure démonstration: collaboration avec un chef panaméen issu de l'Institut Paul Bocuse pour son identité graphique, commissaire d'exposition pour divers événements à Paris, réalisation de collections de foulards... ou travail sur des pièces industrielles!  
**Références:** ACF France, La Crema y Nata / Panama, A piece of chic, 2point1, Zola Eleven... Auto édition IACI et Yvette.

**Education:** BTEC product design Honoré D'Urfé high school — Saint-Étienne  
**Career:** Young designer, Rémi explores all kinds of design opportunities from graphic design to product design and events. His latest experiences: collaboration with a panamean chef of Paul Bocuse Institut, organiser of several exhibitions in Paris, realisation of a scarf collection... or working on industrial pieces.  
**References:** ACF France, La Crema y Nata / Panama, A Piece of chic, 2point1, Zola Eleven... Auto edition IACI et Yvette.



**Quaglio Simonelli**  
quagliosimonelli.com

**Formation:** Università del Progetto de Reggio Emilia, Italie.  
**Expérience:** après des débuts en Italie Manuela Quaglio et Andrea Simonelli sont appelés à rejoindre le Tim Thom (centre de création de Thomson Multimédia). Manuela dirigera le design stratégique mondial de TCL pendant dix ans. Création du studio de design Quaglio Simonelli en 2011.  
**Références:** Barilla, Mandarina Duck, Ligne Roset, L'Oréal, Sintesi et Debi, Alessi, My Fox...  
**Récompenses:** Red Dot Product Design Award. IF Product Design Award. HKDA Award. Kapok Prize. Étoile de l'Observateur. Janus de l'industrie. Plusieurs de leurs produits font partie de la collection du Fond national d'art contemporain au Centre Georges Pompidou, Paris.

**Education:** Università del Progetto, in Reggio Emilia, Italy.  
**Career:** after their start in Italy, Manuela quaglio and Andrea Simonelli are called to join as product designers the Tim Thom, (creative center of Thomson Multimedia). Manuela lead the World Strategic Design of TCL, will last over ten years. In 2011, they decided to create their design studio, signed Quaglio Simonelli.  
**References:** Barilla, Mandarina Duck, Ligne Roset, L'Oréal, Sintesi et Debi, Alessi, My Fox...  
**Awards:** The International Red Dot Product Design Award. IF Product Design Award. the chinese HKDA Award. Kapok Prize. The French Étoile de l'Observateur. The Janus de l'Industrie. Several products they designed are now part of the collection of the National Foundation for Contemporary Art at the Centre Georges Pompidou, Paris.



**Beaverhausen**  
beaverhausen.be | hausmerk.com

**Formation:** Autodidactes passionnés de design. Master en arts graphiques et publicité pour Mimy A. Diar. Bachelor en marketing et communication pour Ad Luijten.  
**Expérience:** Aménagement du magasin de chaussures Waffles à Bruxelles, fauteuil Royale pour Indera présenté au Salon du meuble de Milan en 2011. Création d'objets et accessoires à leur marque Hausmerk, tous made in Belgium.

**Education:** Mimy A. Diar: Master degree in graphic arts and publicity. Ad Luijten: Bachelor's degree in marketing communications.  
**Career:** The interior of Waffles sneaker delicacies in Brussel, the voluptuous armchair called Royale for Belgian manufacturer Indera who was presented at Salone Internazionale del Mobile in 2011. Designing and selling small home accessories directly through their own brand Hausmerk, exclusively made in Belgium.





Ankara Chevet | Bedside table  
→ Page 31



Ankara Table basse | Low table  
→ Page 30



**Ankara** Mange debout  
Bar table  
→ Page 31

**1. Bagoiu** Table range revue  
Magazine rack table  
→ Page 56

**3. Flor** Set de trois tables basses  
Set of three low tables  
→ Page 47

**2. Bise** Set de trois guéridons  
Set of three side tables  
→ Page 54

**4. 3 galets** Set de trois tables basses | Set of three low tables  
→ Page 48



Hegoa Étagère | Shelf  
→ Page 39



Zef H.75 Table | Table  
→ Page 24-25

Zef Banc | Bench  
→ Page 27



Burga Console | Console table  
→ Page 41

Take Chaise | Chair  
→ Page 27

Loo Table triangle  
Triangle table  
→ Page 32





Zephir Chaise | Chair  
→ Page 42

Ankara Tabouret | Stool  
→ Page 31

Ankara Table bistrot  
Bistrot table  
→ Page 31



3 galets Set de trois tables basses | Set of three low tables  
→ Page 48

Zonda H.105  
Table mange debout | Bar table  
→ Page 24

Up 75  
Chaise bar | Bar chair  
→ Page 27





**Hegoa** Table | *Table*  
→ Page 36

**Hegoa** Tabouret | *Stool*  
→ Page 37

**Ponant** Table basse  
*Low table*  
→ Page 45

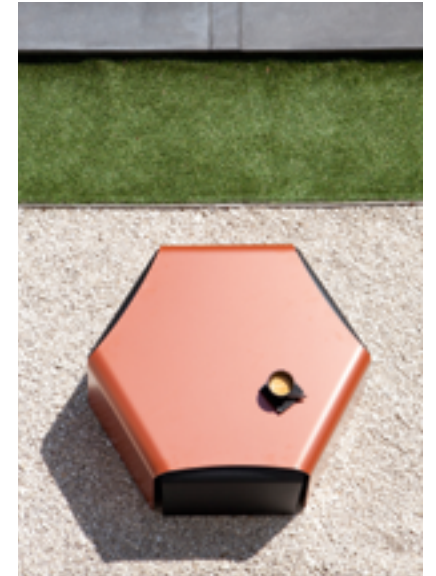

1. **Hegoa** Canapé et extension sans coussin | *Sofa and extension without cushion*  
→ Page 38

2. **Hegoa** Canapé farniente *Farniente sofa*  
→ Page 38

3. **Leste** Bout de canapé *Sofa side unit*  
→ Page 56

3. **Hegoa** Fauteuil | *Armchair*  
→ Page 38

4. **Mistral** Paravent trois volets *Screen three panels*  
→ Page 51

4. **Solano** Table basse porte revue | *Low magazine rack table*  
→ Page 56

4. **Mistral** Paravent sur socle *Screen on base*  
→ Page 51



Cape Chevet rangement haut  
High bedside table storage  
→ Page 46



22	Zef	54	Fleurs   <i>Flowers</i>
28	Ankara	55	Centres de table <i>Table centerpieces</i>
32	Helm + Loo	56	Petit mobilier <i>Small furniture</i>
34	Hegoa		
40	Coulissants <i>Extendable</i>		
42	Zephir		
43	Kuban		
44	Ponant		
46	Cape		
47	Flor		
48	Galets		
50	Mistral		
52	Étagères   <i>Shelves</i>		
53	Xlokk		

Collections

# Collections

# Zef

Design  
**Luc Jozancy**

· 22 ·

· 23 ·

Tables  
Consoles  
Bureau  
Corbeille  
Bancs  
Chaises

*Tables  
Console tables  
Desk  
Document tray  
Benches  
Chairs*



# Zef

La collection Zef se décline dans une large gamme de plateaux combinables avec la hauteur de pieds de votre choix. Voir cahier technique | *The Zef collection is available in a wide range of top sizes to be mixed with the leg height of your choice. See technical guide.*

Choix de pieds effilés ou droits, sauf les hauteurs 30 cm, droits seulement | *Streight or tapered legs available, except height 30 cm, straight legs only.*

Ci-dessous, exemple avec un plateau 70 x 70 cm. Below, example with a 70 x 70 cm top.

1. **Zonda H.105** Table mange debout | *Bar table* (AC) (AL)

2. **Zonda H.90** Table mange debout | *Bar table* (AC) (AL)

3. **Zef H.75** Table | *Table* (AC) (AL)

4. **Zef H.45** Table basse | *Low table* (AC) (AL)

5. **Zef H.30** Table extra-basse | *Extra-low table* (AC) (AL)



1.



2.



3.



4.



5.

→ Page 58

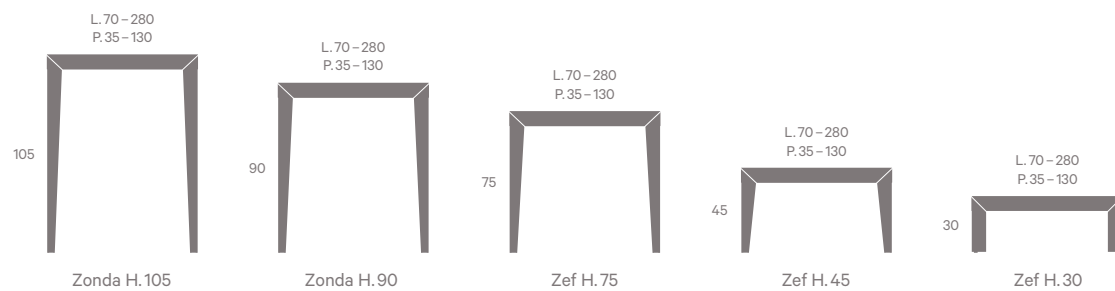

Exemples d'associations pieds et plateaux en hauteur 75 cm (non exhaustif, toutes les tailles en page 58) | *Examples of top sizes with leg height 75 cm (non exhaustive, all sizes on page 58).*



Plateau | *Table top*  
80 x 80 cm



Plateau | *Table top*  
100 x 100 cm



Plateau | *Table top*  
130 x 130 cm



Plateau | *Table top*  
130 x 60 cm



Plateau | *Table top*  
120 x 80 cm



Plateau | *Table top*  
180 x 100 cm



Plateau | *Table top*  
220 x 100 cm



Plateau | *Table top*  
180 x 65 cm



Plateau | *Table top*  
80 x 35 cm



Plateau | *Table top*  
130 x 35 cm



Plateau | *Table top*  
195 x 35 cm

# Zef

6. Console à tiroir  
*Console table with drawer* (AL)  
 Existe aussi sans tiroir  
*Also available without drawer*  
 (AL) (AL)  
 Choix de pieds effilés  
 ou droits | *Streight or tapered*  
*legs available*



6.

7. **Sirocco**  
 Corbeille de rangement  
*Document tray* (AL)



7.

8. Bureau | Desk  
 Disponible avec tiroir ou caisson  
 de rangement | *Available with*  
*drawer or storage box* (AL)  
 Choix de pieds effilés  
 ou droits | *Streight or tapered*  
*legs available*



8.

→ Page 58 – 60

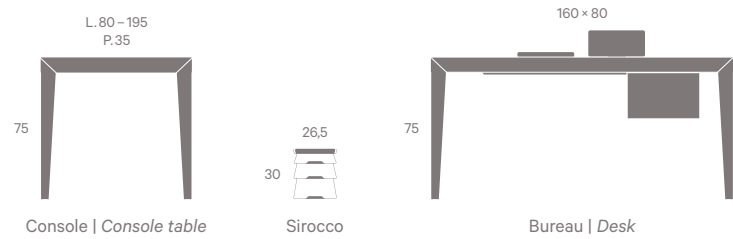

9. Banc | Bench (AL) (AL)  
 Choix de pieds effilés  
 ou droits | *Streight or tapered*  
*legs available*

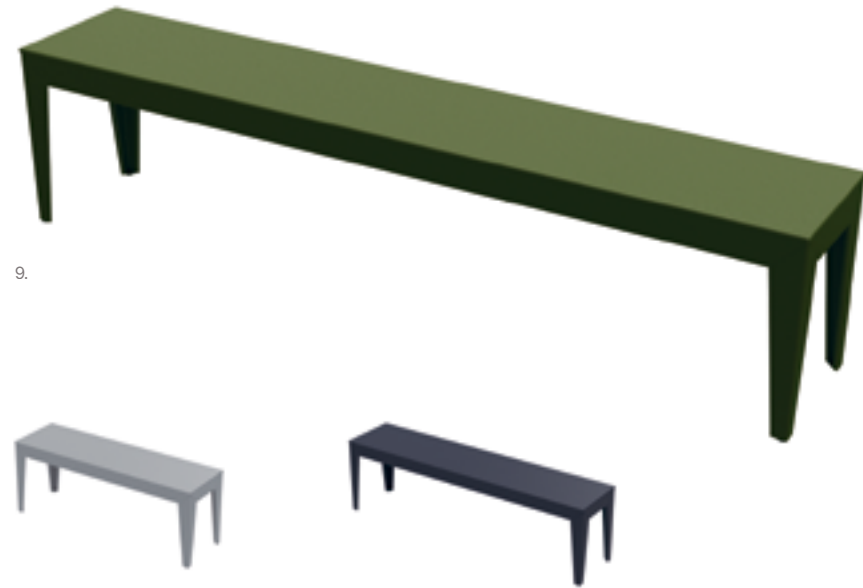

9.

10. **Take** Chaise  
*Chair* (AL) (AL)

11. **Up 65** Chaise bar  
*Bar chair* (AL) (AL)

12. **Up 75** Chaise bar  
*Bar chair* (AL) (AL)



10.



11.



12.

→ Page 58 – 60

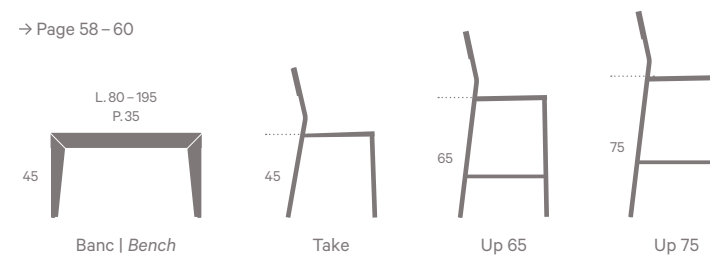

# Ankara

Design  
**Constance Guisset**

· 28 ·

· 29 ·

Mange debout  
Table bistrot  
Table repas  
Table lounge  
Table basse  
Tabouret  
Chevet

*Bar table  
Bistrot table  
Dining table  
Lounge table  
Low table  
Stool  
Bedside table*



# Ankara

1. Table lounge | *Lounge table*  
Plateau rond ou carré  
Round or square top (AC)

2. Table repas | *Dining table*  
Plateau rond ou carré  
Round or square top (AC)

3. Table basse | *Low table*  
Plateau oval | *Oval table top* (AC)



1.



2.



3.

→ Page 60

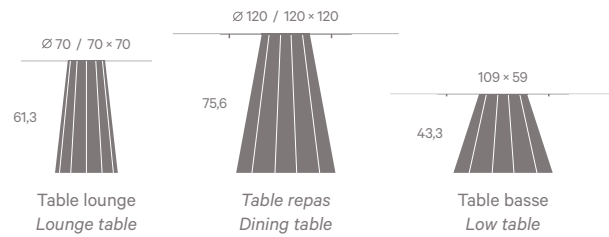

4. Mange debout | *Bar table*  
Plateau rond ou carré  
Round or square top (AC)

6. Tabouret | *Stool*  
Assise ronde | *Round seat* (AC)

5. Table bistrot | *Bistrot table*  
Plateau rond ou carré  
Round or square top (AC)

7. Chevet | *Bedside table*  
Plateau rond ou carré  
Round or square top (AC)



4.



5.



6.



7.

→ Page 60

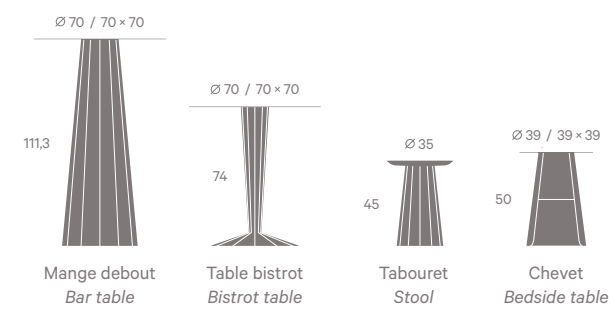

# Helm + Loo

Design  
Luc Jozancy

Fauteuil  
Tables  
Table basse

Armchair  
Tables  
Low table



2.

1. Helm Fauteuil | Armchair (A)

2. Loo Table triangle  
Triangle table (A)

3. Loo Table basse triangle  
Triangle low table (A)

4. Loo Table carré / rond  
Square / round table (A)



1.



3.



4.

→ Page 61



Helm

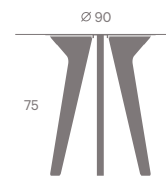

Loo  
Table triangle  
Triangle table

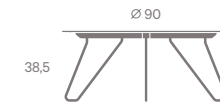

Loo  
Table basse triangle  
Triangle Low table

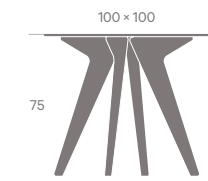

Loo  
Table carrée / rond  
Square / round table

# Hegoa

Design  
**Luc Jozancy**

- 34 -



- 35 -

Tables  
Bancs  
Consoles  
Tabourets  
Fauteuil  
Canapé  
Étagères  
Desserte

*Tables  
Benches  
Console tables  
Stools  
Armchair  
Sofa  
Shelves  
Trolley shelf*



# Hegoa

La collection Hegoa se décline dans une large gamme de plateaux combinables avec la hauteur de pieds de votre choix. Voir cahier technique. *The Hegoa collection is available in a wide range of top sizes to be mixed with the leg height of your choice. See technical guide.*

- 1. Table mange debout *Bar table* (GA)
- 2. Table | *Table* (GA)

- 3. Table basse | *Low table* (GA)
- 4. Option roulettes disponible pour toutes les tables de hauteur 75 | *Wheel option available for leg height 75* (GA)



1.



2.



3.



4.

→ Page 62

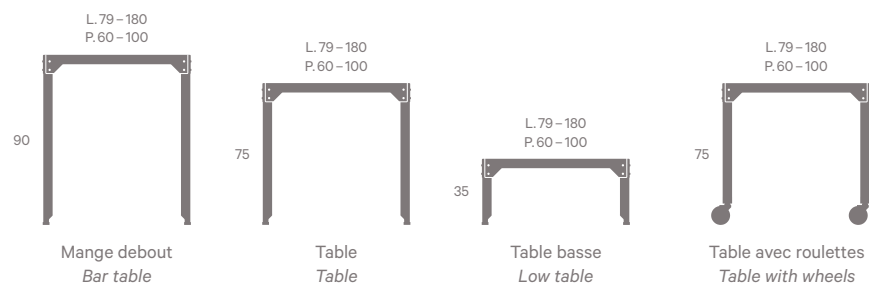

- 5. Console  
*Console table* (GA)

- 6. Banc | *Bench* (GA)
- 7. Tabouret | *Stool* (GA)  
Trois hauteurs disponibles  
*Available in three heights*



5.



6.



7.



→ Page 62

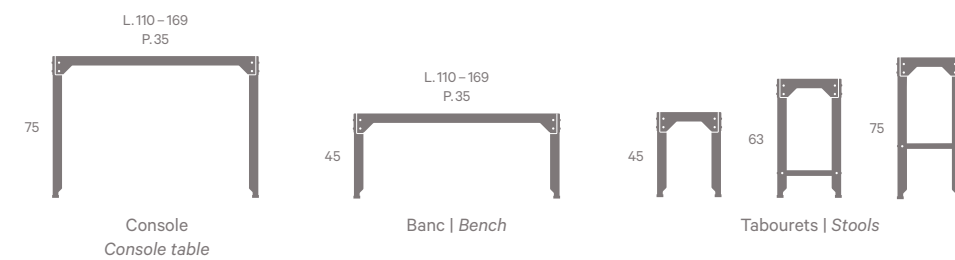

# Hegoa

8. Fauteuil | *Armchair* (GA)

9. Canapé | *Sofa* (GA)

10. Canapé farniente  
*Farniente sofa* (GA)

11. Canapé lounge  
*Lounge sofa* (GA)

Coussins disponibles en noir,  
taupe et blanc | *Cushion*  
available in black, white, beige.



8.



9.



10.



11.



→ Page 61



Fauteuil  
*Armchair*

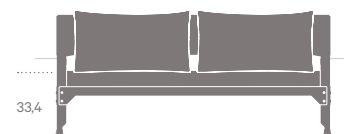

Canapé  
*Sofa*

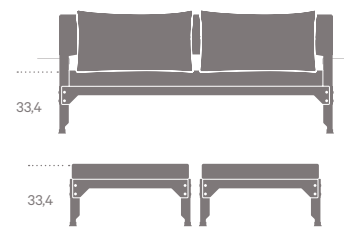

Canapé farniente  
*Farniente sofa*

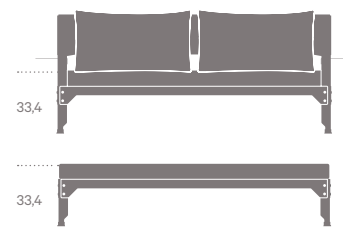

Canapé lounge  
*Lounge sofa*

12. Étagère | *Shelf*  
Nombre de niveaux et dimensions  
au choix | *Available in different*  
sizes (GA)

13. Étagère percée + modules  
amovibles | *Drilled shelf*  
+ *storage removable modules*  
Nombre de niveaux et dimensions  
au choix | *Available in different*  
sizes (GA)

14. Desserte plancha  
*Trolley shelf* (GA)



12.



13.



14.

→ Page 63

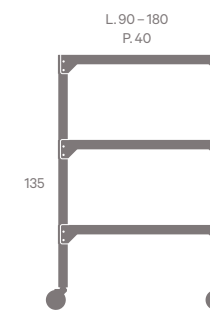
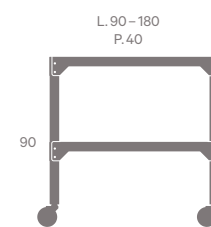

Étagères | *Shelves*

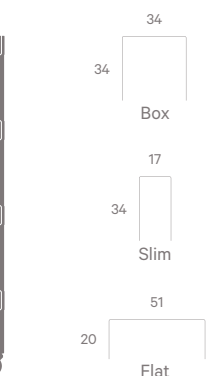
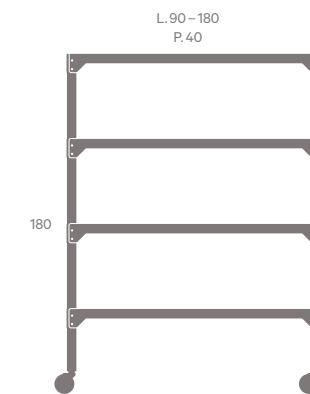

Modules pour étagères percées  
*Storage modules for drilled shelves*

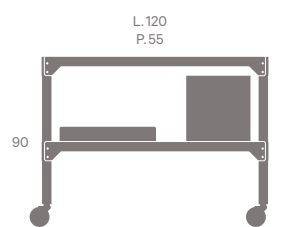

Desserte plancha  
*Trolley shelf*

# Coulissants

Design  
Luc Jozancy

Consoles  
Tables  
Tables basses

Console tables  
Tables  
Low tables



1. **Rafale** Table rectangulaire  
Rectangle extending table (AC)

Aussi disponible | Also available:  
**Rafale** Table rectangulaire XL  
XL Rectangle extending table (AC)  
**Rafale** Table carrée  
Square extending table (AC)

2. **Burga** Console  
Console table (AC)

4. **Tip Top** Table basse  
Low table (AC)



→ Page 64

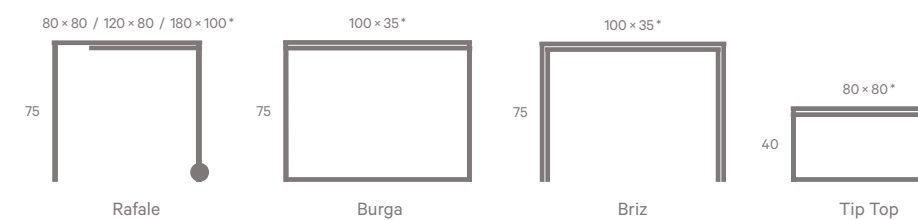

\* Dimensions des plateaux supérieurs, tables fermées. Closed length.

# Zephyr

Design  
**Luc Jozancy**

Table  
Chaise  
*Table  
Chair*

- 1. Table | Table (AL)
- 2. Chaise pliante  
Folding chair (AL)

· 42 ·



→ Page 64

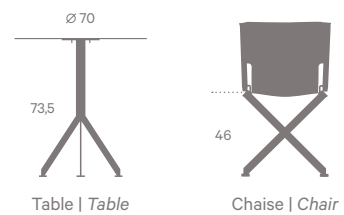

# Kuban

Design  
**Luc Jozancy**

Table guéridon  
Table basse  
*Side table  
Low table*

- 1. Guéridon | Side table (AL)
- 2. Table basse | Low table (AL)

· 43 ·



→ Page 64

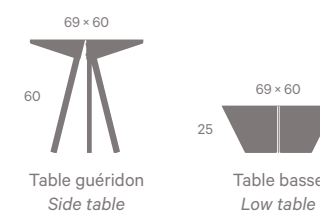

# Ponant

Design  
**Quaglio Simonelli**

Table basse  
*Low table*



Table basse | *Low table*  
AL

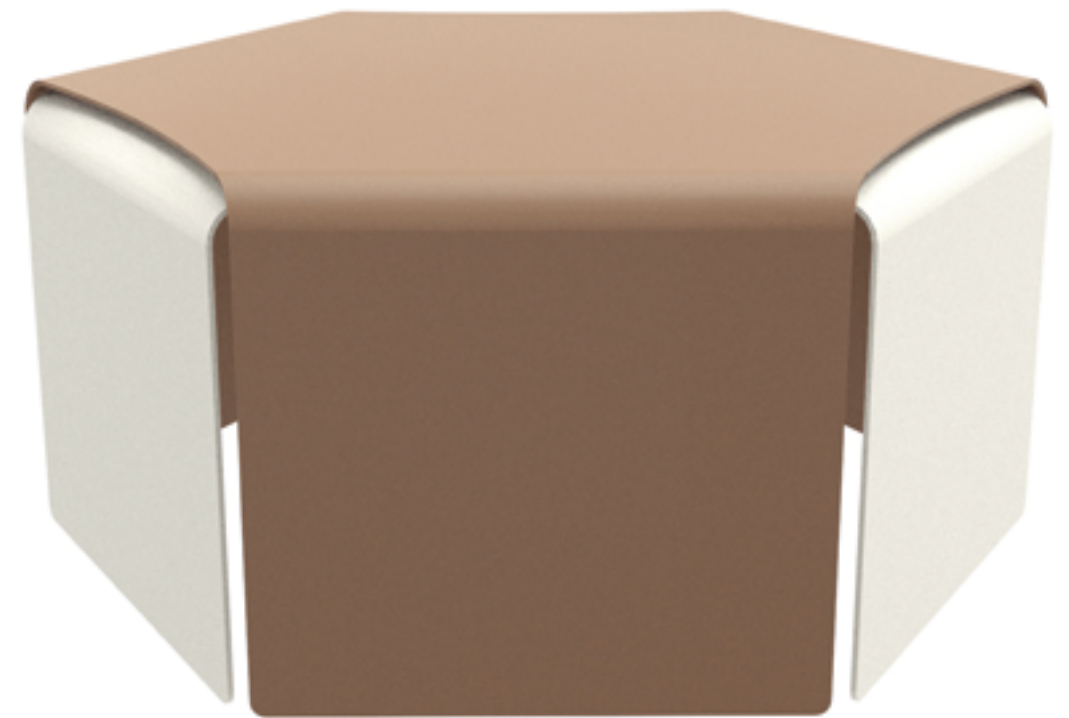

→ Page 65



Table basse | *Low table*

# Cape

Design  
**Luc Jozancy**

Console / rangement  
Chevet / rangement

Console table / storage  
Bedside table / storage

1. Chevet / rangement haut  
High bedside table / storage

2. Console rangement  
Console table / storage

3. Chevet / rangement bas  
Low bedside table / storage

· 46 ·

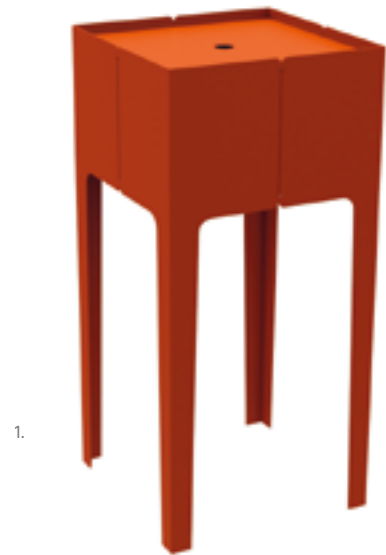

→ Page 65

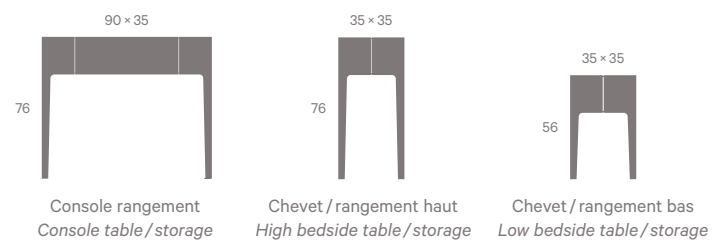

# Flor

Design  
**Beaverhausen**

Tables basses  
Low tables

Set de trois tables basses  
Set of three low tables

· 47 ·

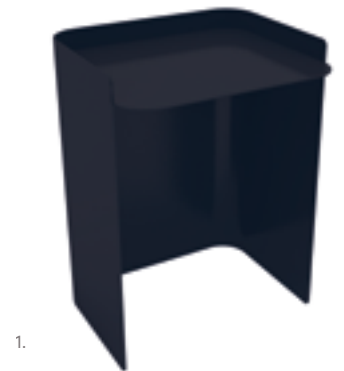
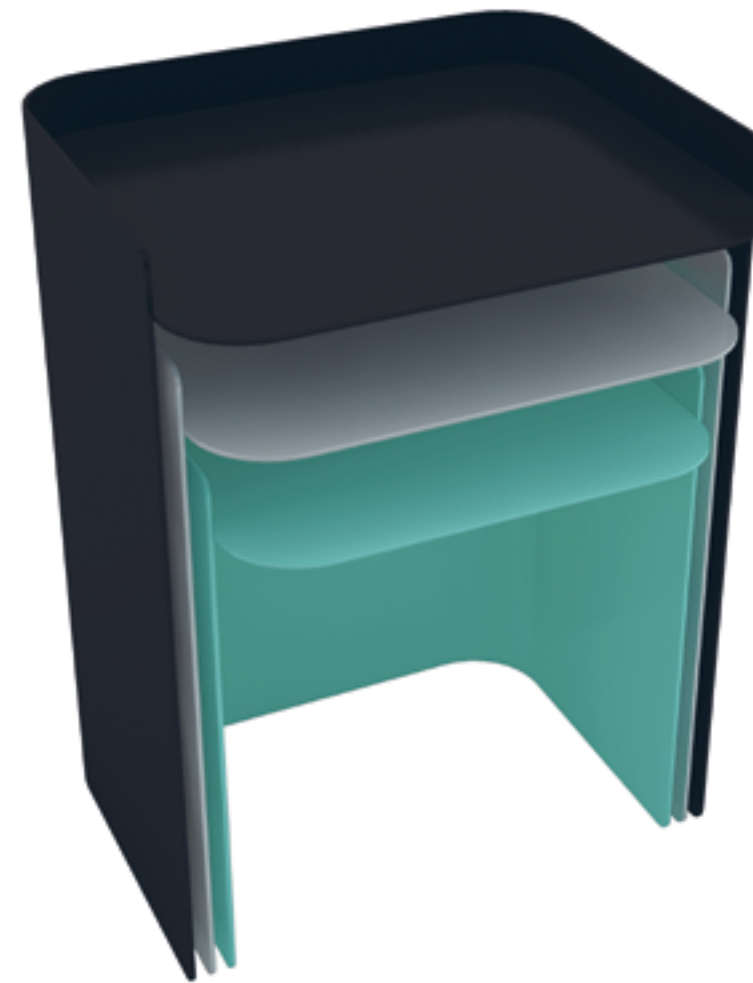

→ Page 65

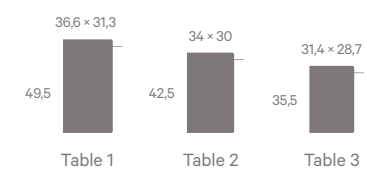

# Galets

Design  
Luc Jozancy

Tables basses  
*Low tables*

**3 galets** Set de trois tables basses | Set of three low tables  
© (A)



→ Page 65

63 × 59	75 × 58	64 × 57
39,9	38,7	37,5
Table 1	Table 2	Table 3

**4. Galet XL** Table basse  
*Low table* ©

**6. Kona** Table basse | *Low table*  
Trois pièces sur l'image  
Three pieces shown © (A)

5. Exemples de mix table Galet XL + table Galet n°1 et/ou n°3 de la page 48 | *Examples Galet XL with Galet low table n°1 and/or n°3 on page 48*



→ Page 65

120 × 80	63 × 51,6
38,7	39
Galet XL	Kona

# Mistral

Design  
**Luc Jozancy**

Clastras  
Screens

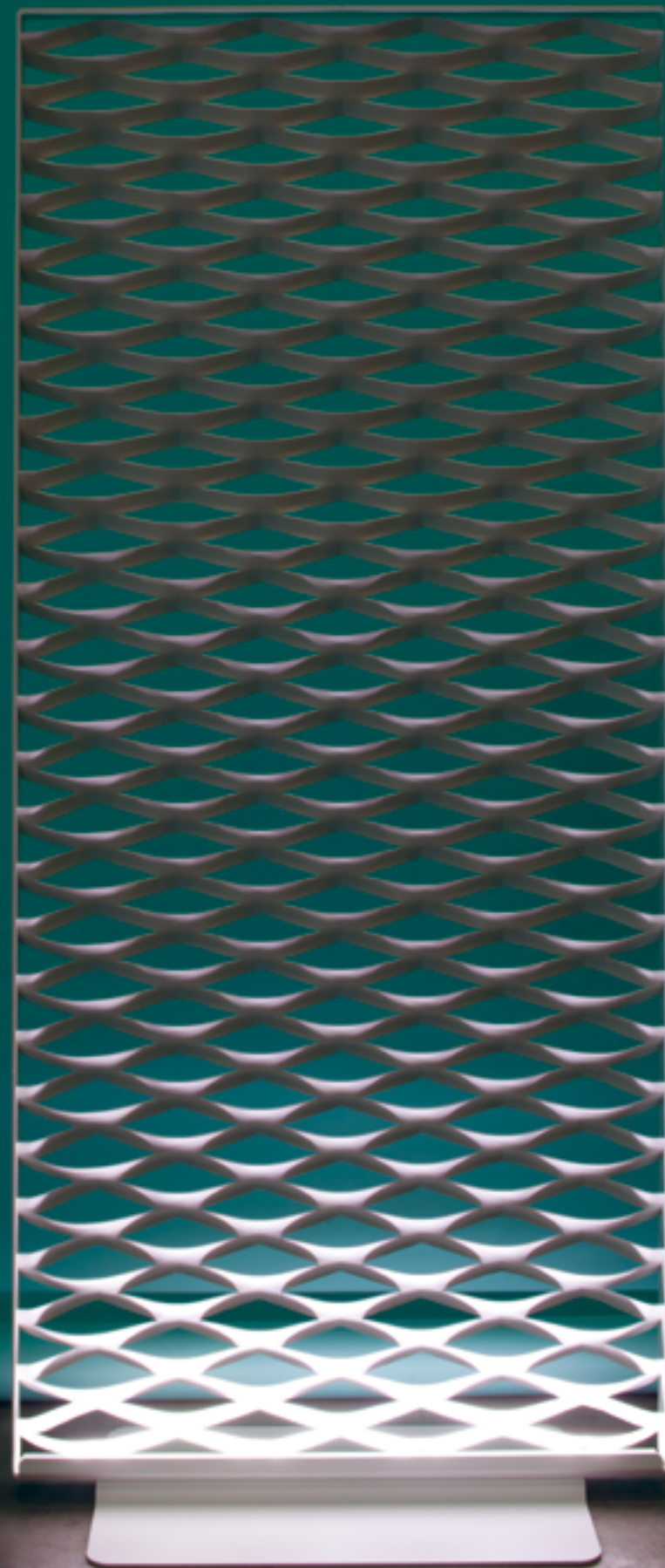

1. Clastra paravent trois volets  
Screen three panels

En option | Option:  
Éclairage leds blanc ou RVB  
White or RGB Led lighting

2. Clastra sur socle  
Screen on base



1.



2.

→ Page 66

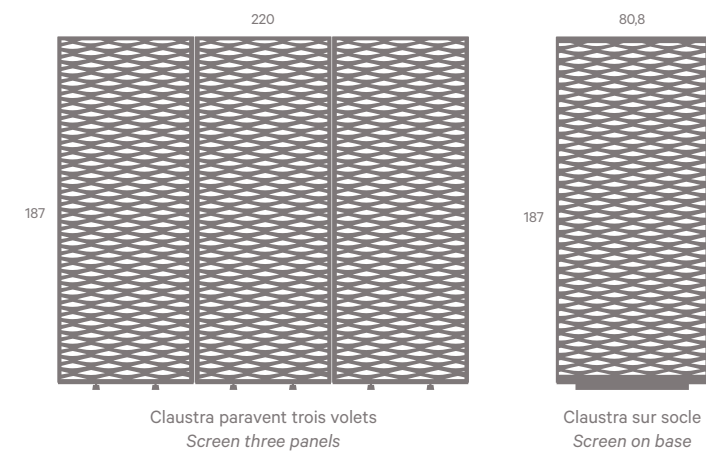

# Étagères

Design  
Luc Jozancy

## Shelves

1. **Knick** Range livres | Book shelves (A)

2. **Knick** Combinaison possible range livre et range magazine  
Mix of book and magazine shelves (A)

3. **Knick** Range magazines  
Magazine shelves (A)

4. **Pampero** Étagère | Shelf (A)

5. **Alizé** Étagère rail à tiroirs  
Shelf with drawers (A)

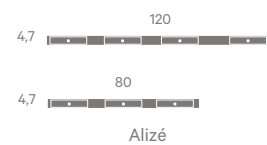
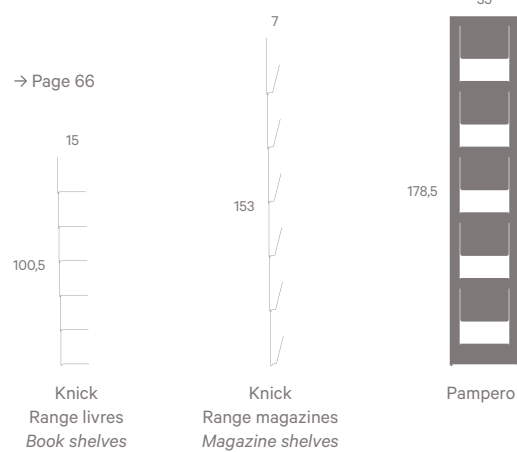
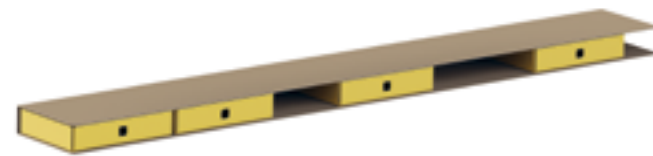
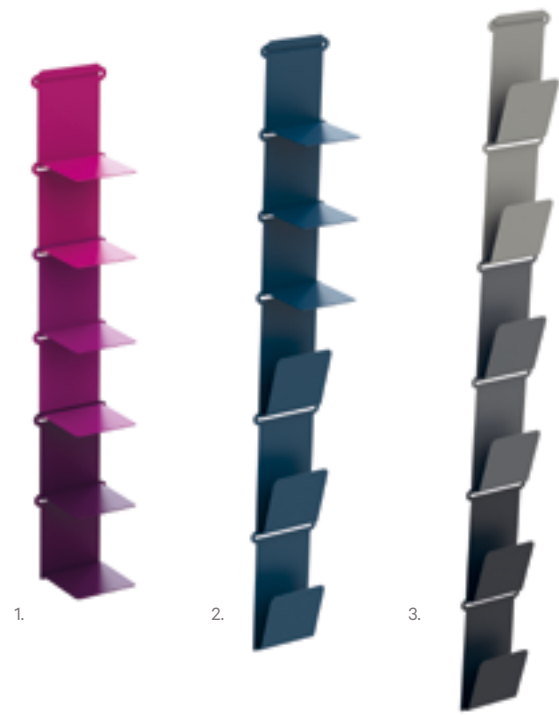

# Xlokk

Design  
Luc Jozancy

## Portes-manteaux Coat racks

1. Porte-manteau deux pieds  
à fixer au mur | Coat rack  
two legs to be fixed on a wall (A)

2. Porte-manteau quatre pieds  
Coat rack four legs (A)

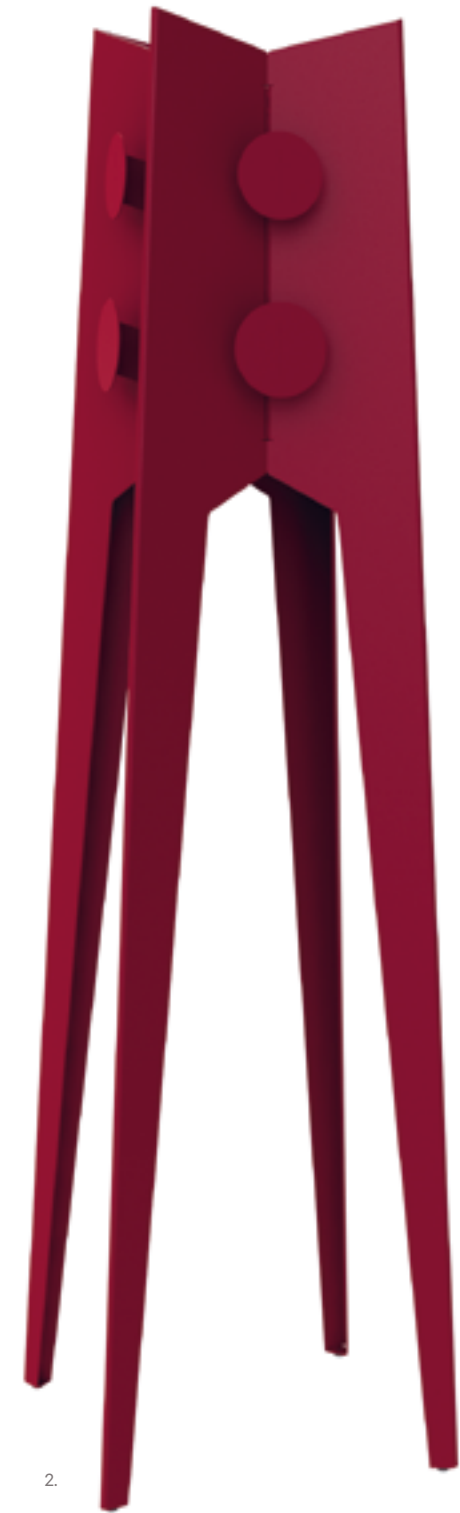

→ Page 67

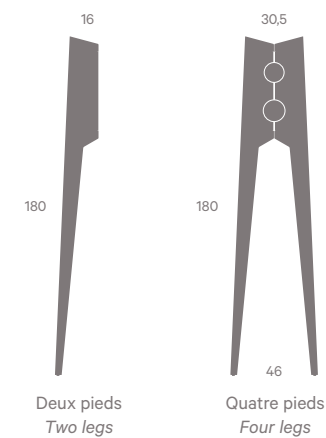

# Fleurs

Design  
Luc Jozancy

Tables basses  
Flower  
low tables

1. **Bise** Set de trois guéridons  
Set of three side tables (AC)
2. **Notus XL** Table basse  
Low table (AC) (AL)
3. **Notus** Table basse | Low table  
(AC) (AL)

· 54 ·



1.



2.



3.

→ Page 67

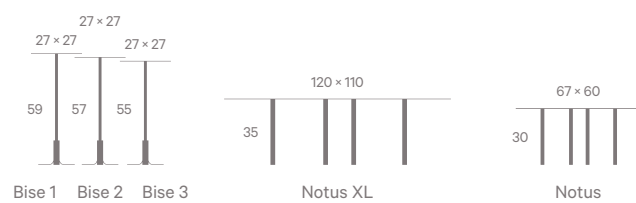

# Centres de table

Table  
centerpieces

1. **Lips** Luc Jozancy
2. **Bora** Luc Jozancy
3. **Baguette** Luc Jozancy
4. **Pixel** Luc Jozancy
5. **Cyclone** Luc Jozancy
6. **Eurus** Rémi Cassado
7. **Simoon** Rémi Cassado
8. **Frisk** Constance Guisset (AC)

· 55 ·



1.



2.



3.



4.

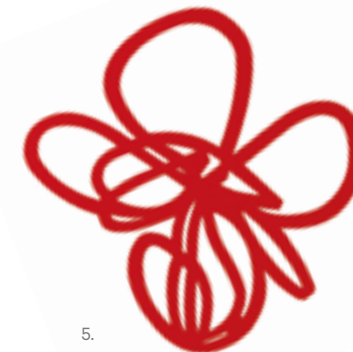

5.



6.

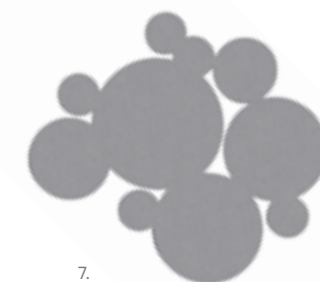

7.



8.

→ Page 67

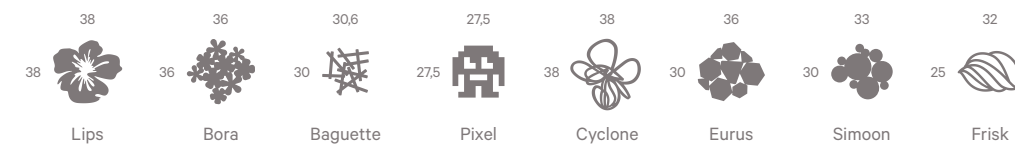

# Petit mobilier

Design  
Luc Jozancy

Small  
furniture

1. **Leste** Bout de canapé  
Sofa side unit (AL)
2. **Baguio** Table range revue  
Magazine rack table (AL)
3. **Fun** Tabouret | Stool (AL)
4. **Solano** Table basse  
porte revue | Low magazine  
rack table (AL)

· 56 ·

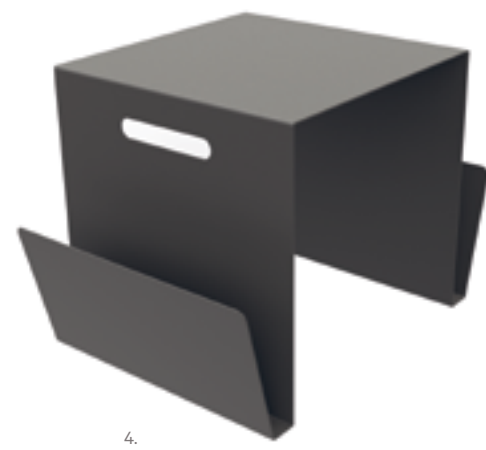

→ Page 67

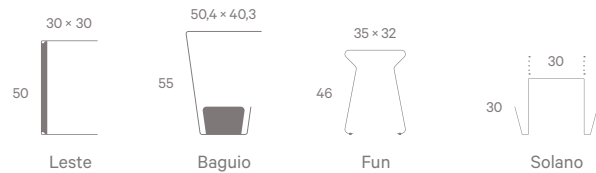

Technical guide

Légendes des pictogrammes | Pictograms  
→ Rabat de couverture | On inside cover

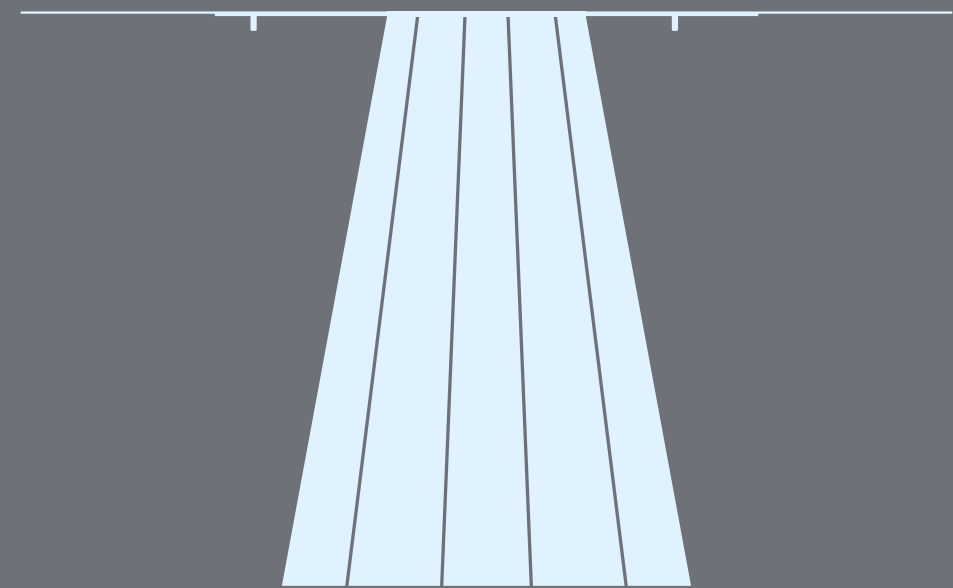

Cahier  
technique

# Zef

Tables, bancs et consoles | *Tables, benches and console tables*  
Plateaux disponibles | *Table top available:*

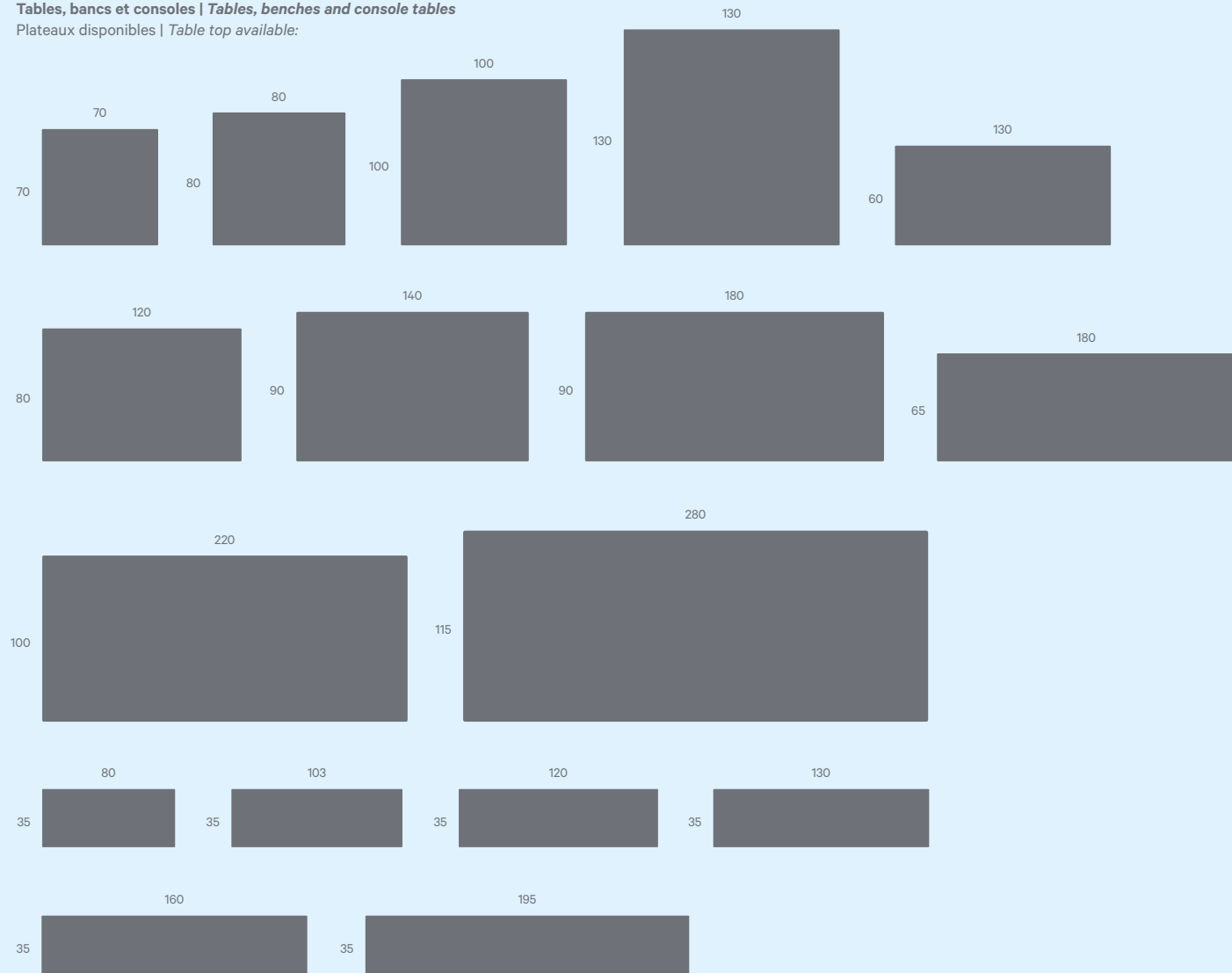

Hauteurs de pieds disponibles | *Available leg heights:*



Tableau des combinaisons possibles :  
*Mix and match tops with leg heights:*

⊙ = ⊕ ⊖ = ✖

Embouts de pieds réglables vissés en Polyéthylène.  
*A polyethylene adjustable cap is fitted on each leg.*

Tailles plateaux <i>Table top sizes</i>	Hauteurs des pieds   <i>Leg heights</i>				
	30	45	75*	90	105
70 × 70	⊙ ⊖ ✖	⊙ ⊖ ✖	⊙ ⊖ ✖	⊙ ⊖ ✖	⊙ ⊖ ✖
80 × 80	⊙ ⊖ ✖	⊙ ⊖ ✖	⊙ ⊖ ✖	⊙ ⊖ ✖	⊙ ⊖ ✖
100 × 100	⊙ ⊖ ✖	⊙ ⊖ ✖	⊙ ⊖ ✖	⊙ ⊖ ✖	⊙ ⊖ ✖
130 × 130	⊙ ⊖ ✖	⊙ ⊖ ✖	⊙ ⊖ ✖	⊙ ⊖ ✖	⊙ ⊖ ✖
130 × 60	⊙ ⊖ ✖	⊙ ⊖ ✖	⊙ ⊖ ✖	⊙ ⊖ ✖	⊙ ⊖ ✖
120 × 80	⊙ ⊖ ✖	⊙ ⊖ ✖	⊙ ⊖ ✖	⊙ ⊖ ✖	⊙ ⊖ ✖
140 × 90	⊙ ⊖ ✖	⊙ ⊖ ✖	⊙ ⊖ ✖	⊙ ⊖ ✖	⊙ ⊖ ✖
180 × 65	⊙ ⊖ ✖	⊙ ⊖ ✖	⊙ ⊖ ✖	⊙ ⊖ ✖	⊙ ⊖ ✖
180 × 90	⊙ ⊖ ✖	⊙ ⊖ ✖	⊙ ⊖ ✖	⊙ ⊖ ✖	⊙ ⊖ ✖
220 × 100	⊙ ⊖ ✖	⊙ ⊖ ✖	⊙ ⊖ ✖	⊙ ⊖ ✖	⊙ ⊖ ✖
280 × 115	⊙ ⊖ ✖	⊙ ⊖ ✖	⊙ ⊖ ✖	⊙ ⊖ ✖	⊙ ⊖ ✖
80 × 35	⊙ ⊖ ✖	⊙ ⊖ ✖	⊙ ⊖ ✖	⊙ ⊖ ✖	⊙ ⊖ ✖
103 × 35	⊙ ⊖ ✖	⊙ ⊖ ✖	⊙ ⊖ ✖	⊙ ⊖ ✖	⊙ ⊖ ✖
120 × 35	⊙ ⊖ ✖	⊙ ⊖ ✖	⊙ ⊖ ✖	⊙ ⊖ ✖	⊙ ⊖ ✖
120 × 35 + ⊞	•	•	⊙ ⊖ ✖	⊙ ⊖ ✖	⊙ ⊖ ✖
130 × 35	⊙ ⊖ ✖	⊙ ⊖ ✖	⊙ ⊖ ✖	⊙ ⊖ ✖	⊙ ⊖ ✖
160 × 35	⊙ ⊖ ✖	⊙ ⊖ ✖	⊙ ⊖ ✖	⊙ ⊖ ✖	⊙ ⊖ ✖
195 × 35	⊙ ⊖ ✖	⊙ ⊖ ✖	⊙ ⊖ ✖	⊙ ⊖ ✖	⊙ ⊖ ✖

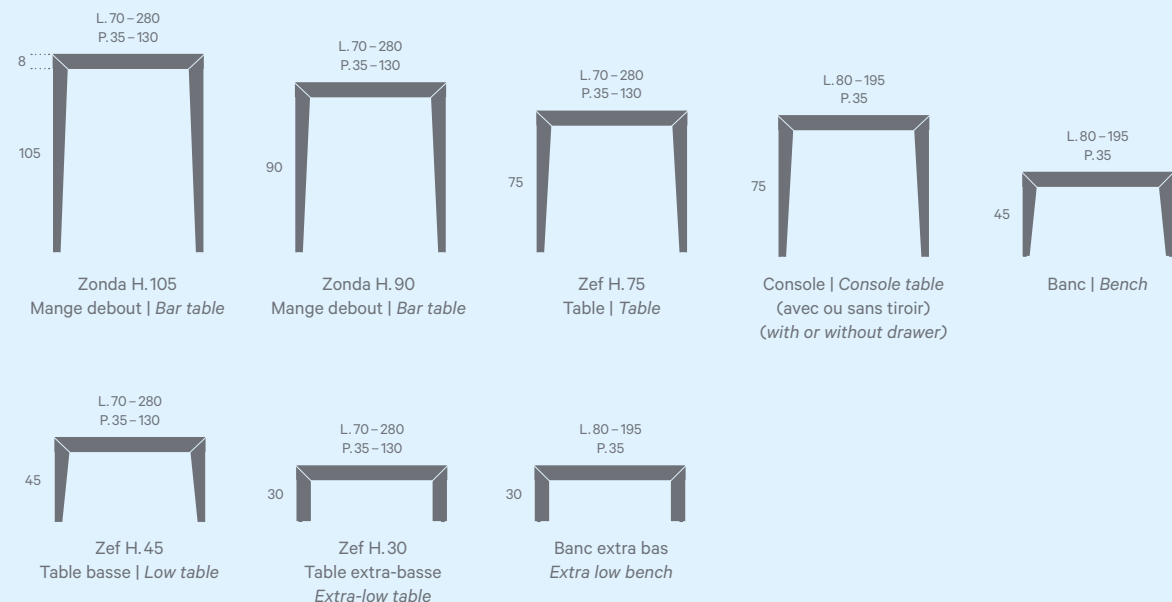
\* Poids des tables hauteur 75 cm à titre indicatif  
*The weight of the tables height 75 cm are on an indicative basis*

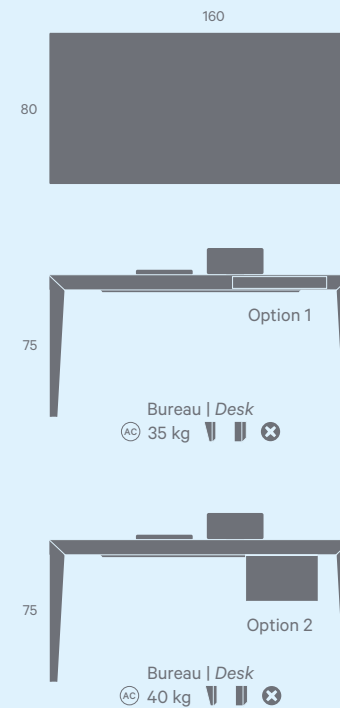

### Bureau | Desk — Option 1

Équipé avec | *Comes with:*  
– Un tiroir | *One drawer* 59,8 × 33 × 6 cm  
– Rangement fronton. Au choix deux modules:  
*Two storage modules of your choice:*

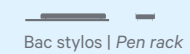

– Passe câble sous le plateau et dans les deux pieds avant | *Cable grommet underneath the desk top and in the two front legs.*

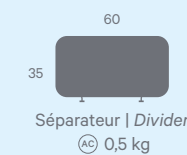

### Accessoires bureau

– Séparateur pour confort acoustique et visuel aimanté à la base. Housse en feutre, épaisseur 3 mm. Coloris au choix : orange, noir, rose, gris beige clair chiné. Deux formats au choix.  
– Fond de tiroirs en feutre 56 × 31,5 cm, épaisseur 3 mm. Coloris au choix idem feutre séparateur ci-dessus.

### Bureau | Desk — Option 2

Idem ci-contre mais remplacement du tiroir par un caisson de rangement pour dossiers suspendus (non fournis) en aluminium et un bac stylos déplaçable | *Available with storage module instead of the drawer.*

Format caisson | *Storage box size:*  
50 × 29 × 37 cm

Bureau et caisson de couleurs différentes possible (façade tiroir caisson de la même couleur que le bureau) | *Desk and storage module available in different colors.*

### Desk accessories

– Acoustic and privacy divider in felt, thickness 3 mm with magnetic base. Colours : orange, black, pink, light grey beige. Two sizes available.  
– Felt for drawer. 56 × 31,5 cm, thickness 3 mm. Same colours available as the acoustic felt divider.

## Sirocco

Composez votre système de corbeille comme vous le souhaitez.  
Mix and match tops of your choice.

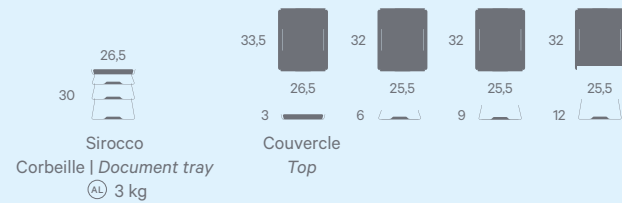

Sirocco  
Corbeille | Document tray  
AL 3 kg

Couvercle  
Top

## Take + Up

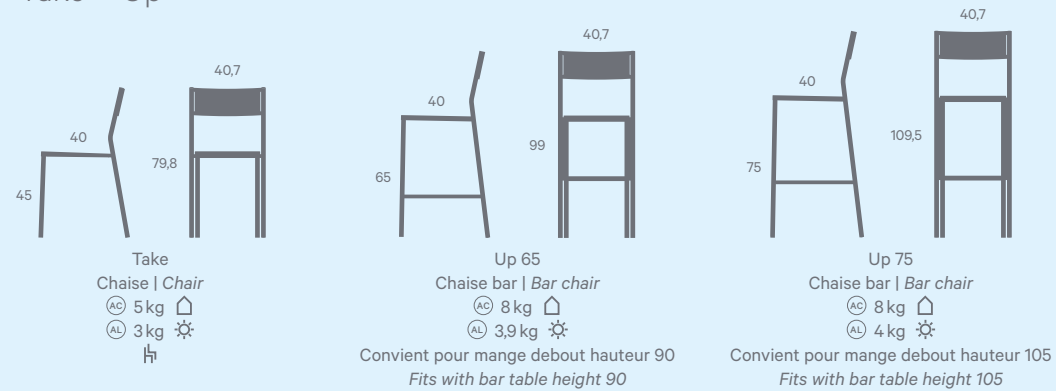

Take  
Chaise | Chair  
AC 5 kg  
AL 3 kg

Up 65  
Chaise bar | Bar chair  
AC 8 kg  
AL 3,9 kg

Up 75  
Chaise bar | Bar chair  
AC 8 kg  
AL 4 kg

Convient pour mange debout hauteur 90  
Fits with bar table height 90

Convient pour mange debout hauteur 105  
Fits with bar table height 105

Patins de protection sous les quatre pieds  
Protective pads under the four legs

## Ankara

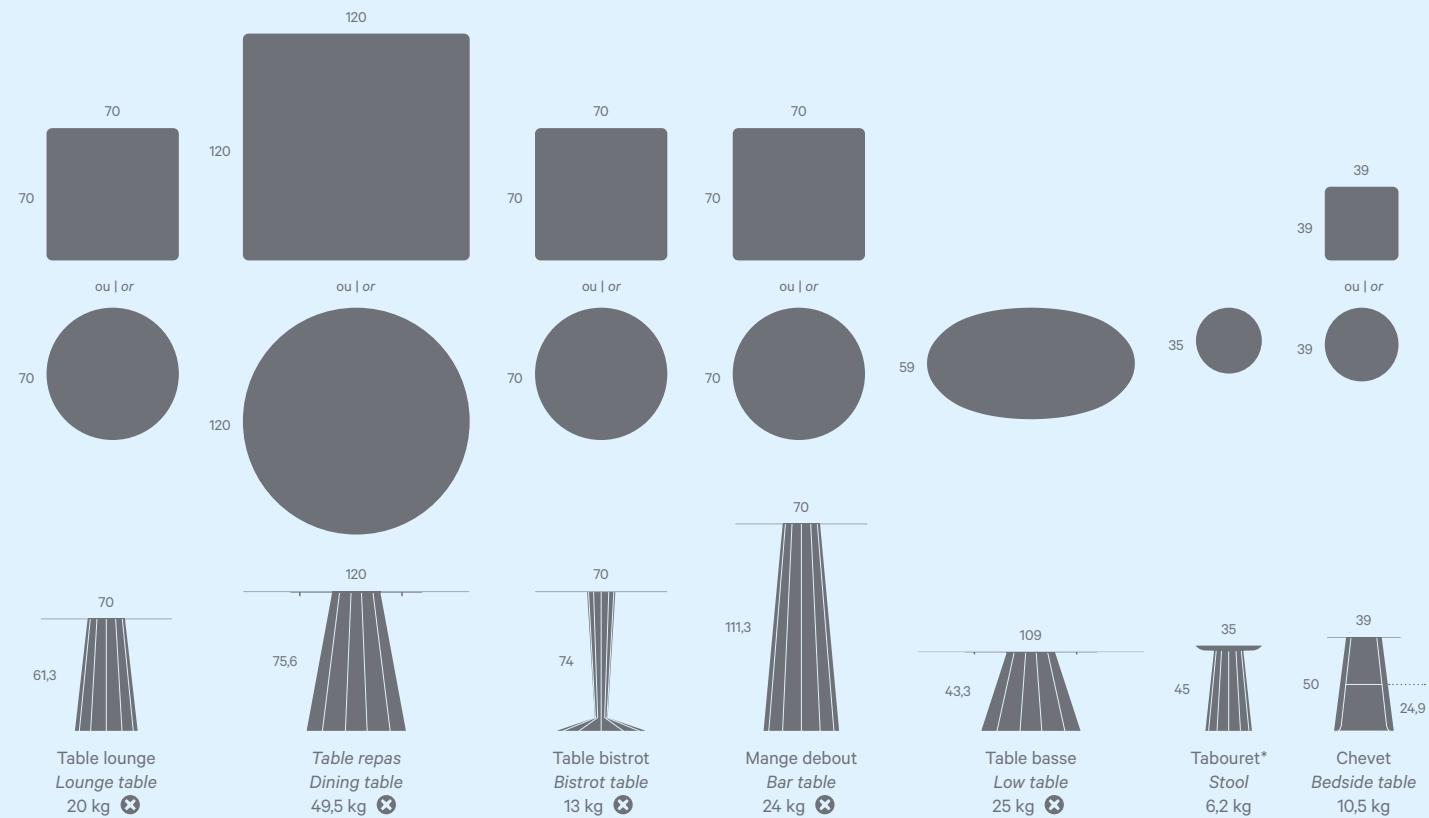

Table lounge  
Lounge table  
20 kg

Table repas  
Dining table  
49,5 kg

Table bistrot  
Bistrot table  
13 kg

Mange debout  
Bar table  
24 kg

Table basse  
Low table  
25 kg

Tabouret\*  
Stool  
6,2 kg

Chevet  
Bedside table  
10,5 kg

Épaisseur acier | Steel thickness 3 mm  
Patins de protection sous les pieds | Protective pads under legs  
AC

\* Assise chêne massif vernis mat anti tâche  
Oak woodentop with anti-mark varnish

## Helm

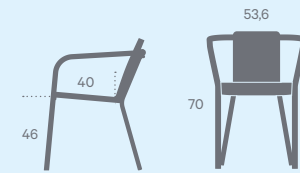

Fauteuil | Armchair  
AL 9 kg

Le fauteuil peut s'utiliser avec ou sans coussin.  
The armchair can be used with or without cushion.

Coussin dossier | Backrest cushion  
Coloris tissus outdoor déperlant : noir, blanc, orange. Nettoyage à l'eau avec une éponge humide. Pas de nettoyage à sec. Fixation du coussin sur le dossier par élastique et patte sur l'assise.

Outdoor water resistant fabric.  
Colours: black, white, orange. Cleaning with a wet sponge. No dry cleaning. Cushion to be fixed on the backrest with an elastic and on the seat with a removable system.

## Loo

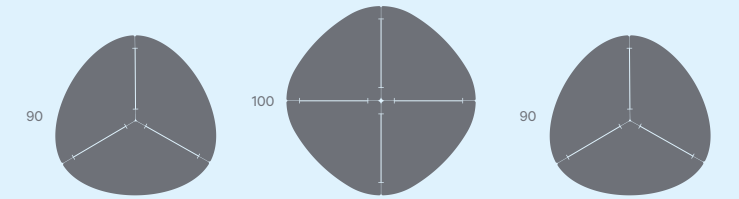

Table triangle  
Triangle table  
Trois pieds caissonnés  
Three angled legs  
AL 11,5 kg

Table carrée / rond  
Square / round table  
Quatre pieds caissonnés  
Four angled legs  
AL 20 kg

Table basse triangle  
Triangle low table  
Pieds inox | Stainless steel legs  
AL 13 kg

## Hegoa

Fauteuil et canapé | Armchair and sofa

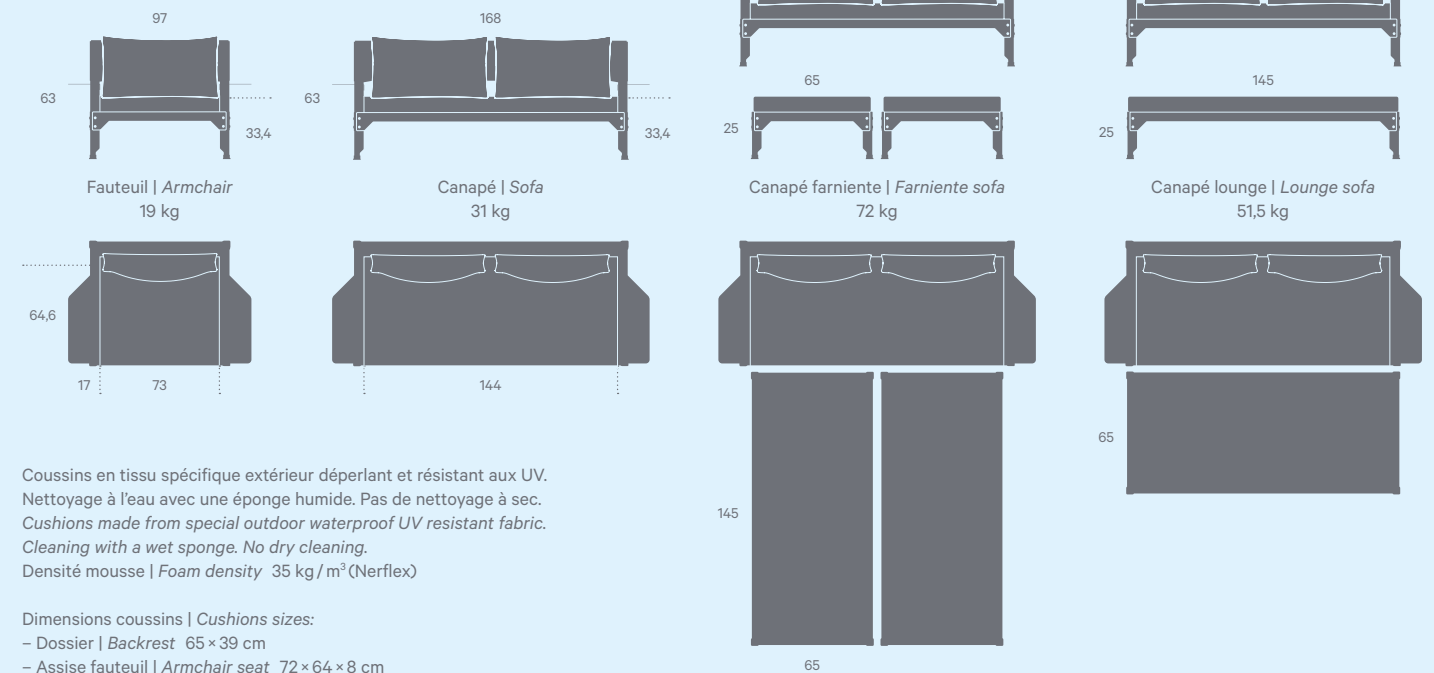

Coussins en tissu spécifique extérieur déperlant et résistant aux UV. Nettoyage à l'eau avec une éponge humide. Pas de nettoyage à sec. Cushions made from special outdoor waterproof UV resistant fabric. Cleaning with a wet sponge. No dry cleaning. Densité mousse | Foam density 35 kg / m³ (Nerflex)

Dimensions coussins | Cushions sizes:  
- Dossier | Backrest 65 x 39 cm  
- Assise fauteuil | Armchair seat 72 x 64 x 8 cm  
- Assise canapé | Sofa seat 144 x 64 x 8 cm  
- Extension | Extension 144 x 65 x 8 cm

Trois coloris au choix: Sling noir, Sling blanc, Sling taupe (dossier et assise de même coloris) | Available in three colours: Sling black, Sling white, Sling beige (backrest and seat in the same colour).



# Hegoa

Tables, consoles, bancs et tabourets | Tables, console tables, benches and stools  
Plateaux disponibles | Available table tops:

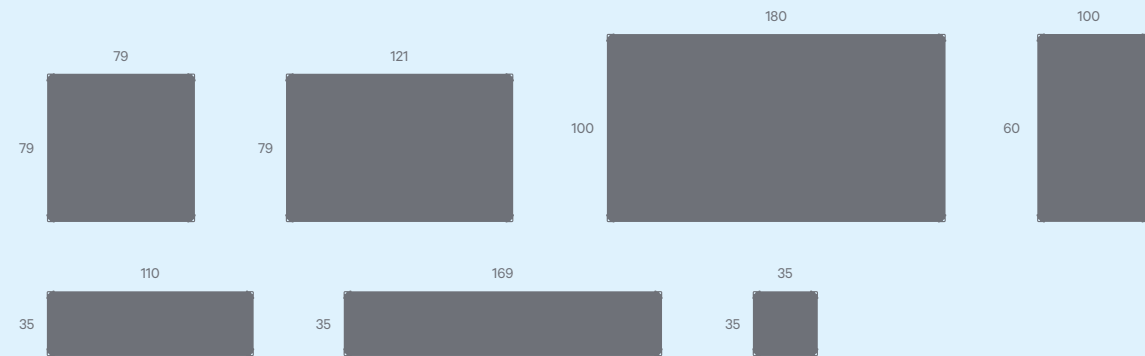

Hauteurs de pieds disponibles | Available leg heights:



Tableau des combinaisons possibles:  
Mix and match tops with leg heights:

Tailles plateaux   Table tops sizes	Hauteurs des pieds   Leg heights					
	35	45	63	75*	90	75 roulettes   wheels
79 x 79	GA, X, ZB	GA, X, ZB	•	GA 17 kg, X, ZB	GA, X, ZB	GA, X, ZB
121 x 79	GA, X, ZB	GA, X, ZB	•	GA 23 kg, X, ZB	GA, X, ZB	GA, X, ZB
180 x 100	GA, X, ZB	GA, X, ZB	•	GA 33 kg, X, ZB	GA, X, ZB	GA, X, ZB
100 x 60	GA, X, ZB	GA, X, ZB	•	GA 17 kg, X, ZB	GA, X, ZB	GA, X, ZB
110 x 35	GA, X, ZB	GA, X, ZB	•	GA 13 kg, X, ZB	GA, X, ZB	GA, X, ZB
169 x 35	GA, X, ZB	GA, X, ZB	•	GA 18 kg, X, ZB	GA, X, ZB	GA, X, ZB
35 x 35	GA, X, ZB	GA, X, ZB	GA, X, ZB	GA 8 kg, X, ZB	GA, X, ZB	•

\* Poids des tables hauteur 75 cm à titre indicatif  
The weight of the tables height 75 cm are on an indicative basis

## Étagères | Shelves

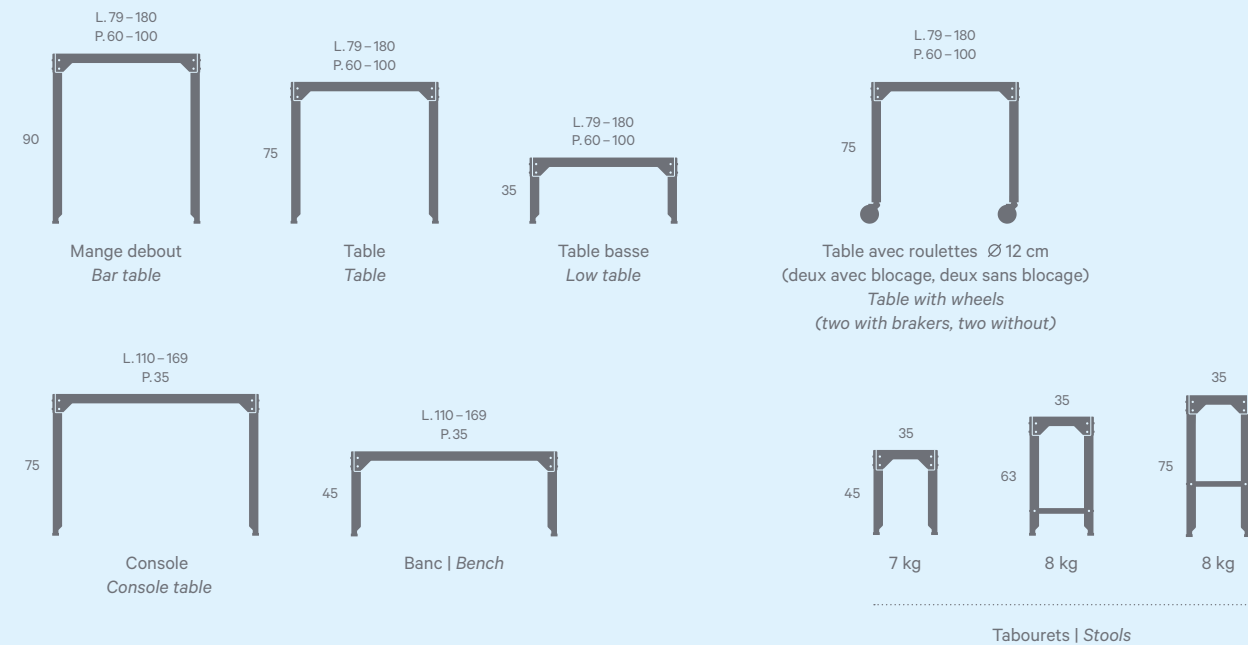
Deux choix possible:  
- Non percées  
- Percées pouvant recevoir des modules (perçage tous les 17 cm)

Two options available:  
- No drilled  
- Drilled for storage modules (drilled every 17 cm)

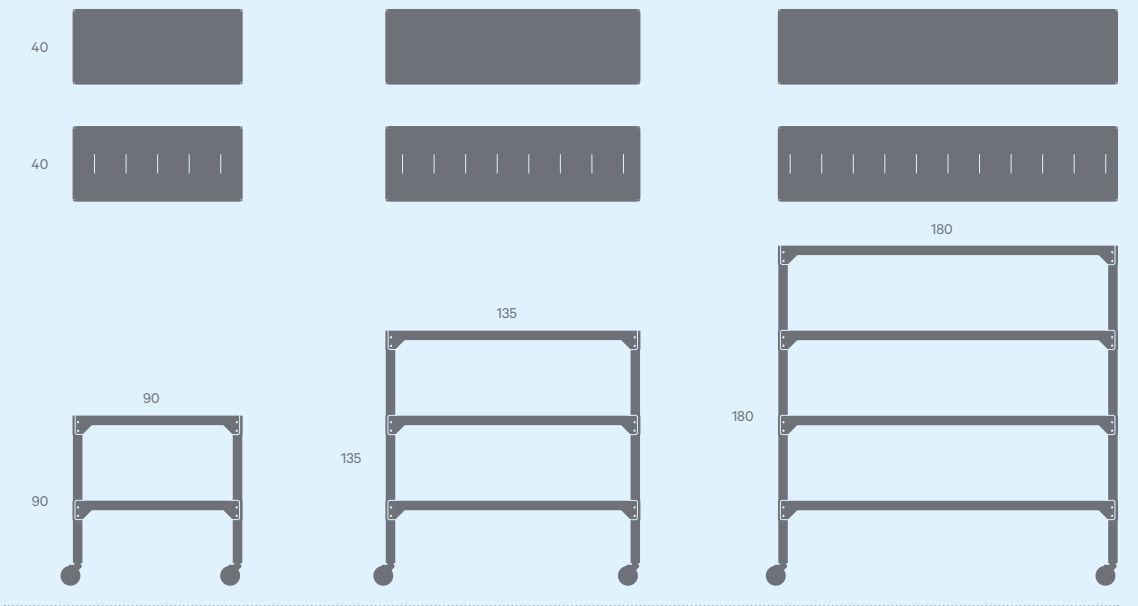

## Étagères | Shelves

Étagères percées: il est nécessaire de toujours laisser un espace entre deux modules de rangement. Ne pas surcharger l'étagère de modules, pour un effet visuel optimal. Nombre de modules recommandés:  
- Longueur 90 1 à 2 modules  
- Longueur 135 1 à 3 modules  
- Longueur 180 1 à 4 modules

Drilled shelving units: a space should always be left between two storage modules. For the most attractive visual effect do not overload the shelving unit with modules. We advise:  
- Length 90 1 to 2 modules maximum  
- Length 135 1 to 3 modules maximum  
- Length 180 1 to 4 modules maximum

Tableau des combinaisons possibles:  
Mix and match tops with leg heights:

Tailles plateaux   Table tops sizes	Nombre de plateaux   Number of tops		
	2 (H.90)	3 (H.135)	4 (H.180)
40 x 90	GA 28 kg, X, ZB	GA 34 kg, X, ZB	•
40 x 135	GA 30 kg, X, ZB	GA 45 kg, X, ZB	GA 60 kg, X, ZB
40 x 180	GA 37 kg, X, ZB	GA 55 kg, X, ZB	GA 70 kg, X, ZB

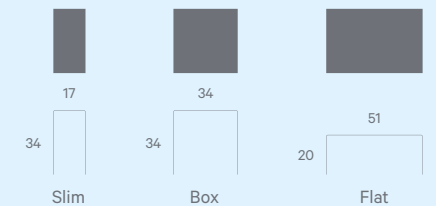

Modules amovibles pour étagères percées  
Removable storage modules for drilled shelves  
GA 7 kg, X

## Desserte plancha Trolley shelf

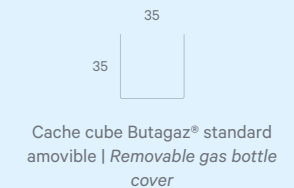
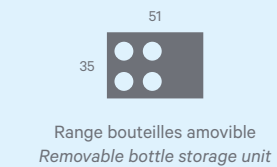
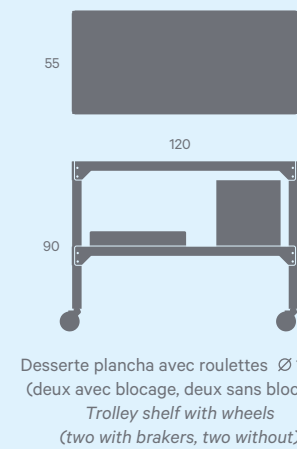

GA 41 kg, X, ZB

Coulissants | *Extendable*

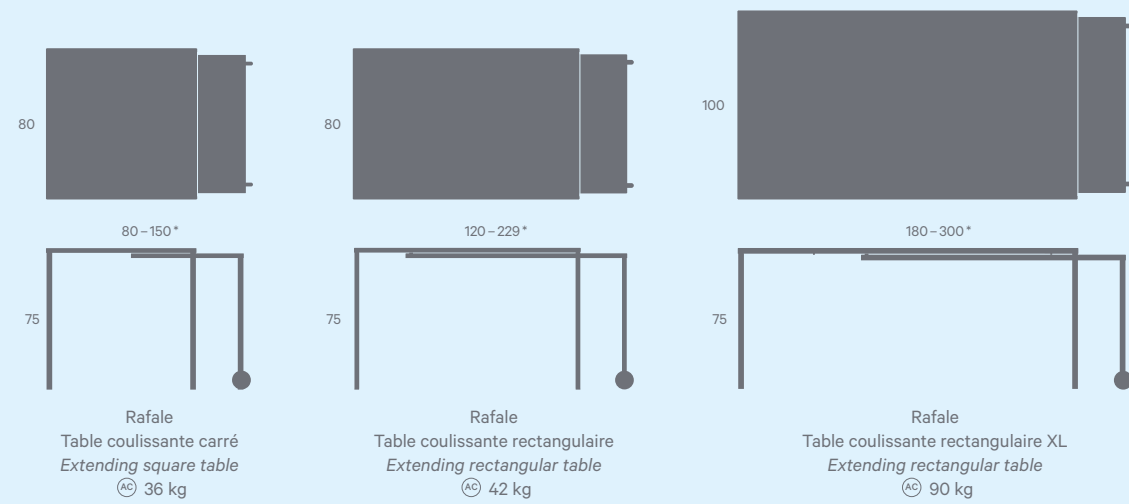

\* Taille fermée - ouvert  
Size closed - open

Arrêt position  
intermédiaire grâce  
à une encoche au milieu  
de la trajectoire  
du plateau inférieur.  
Integrated block system  
half way of the  
opening of the table.

Roulettes sous deux pieds | wheels on two legs Ø 10 cm  
Pieds tube carré | Square legs 2,5 x 2,5 cm  
Ⓢ ✕

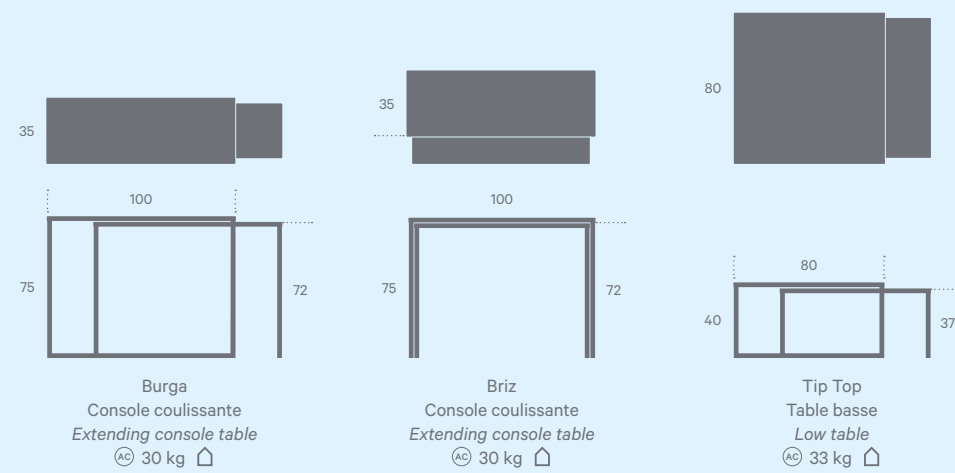

Zephir

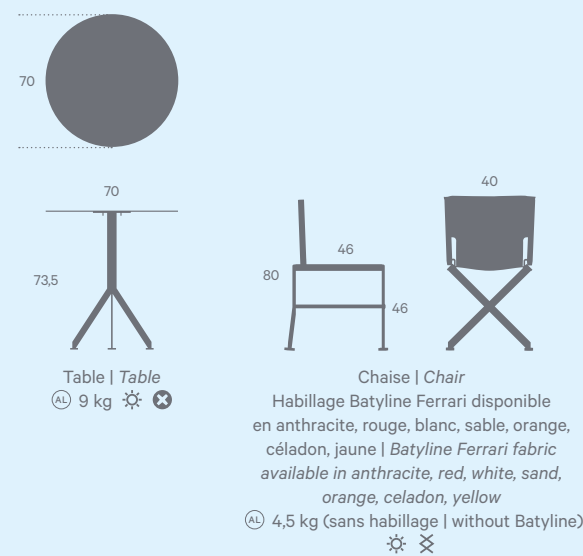

Kuban

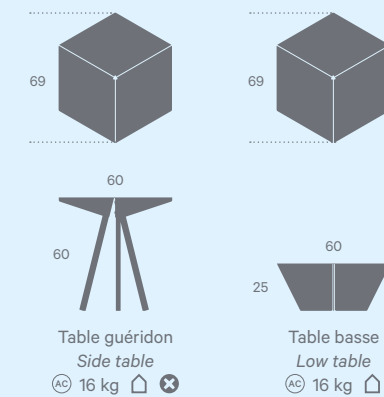

Ponant

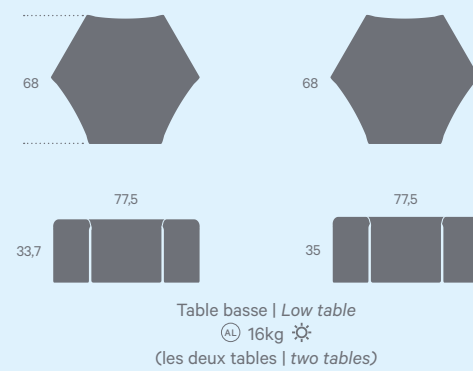

Cape

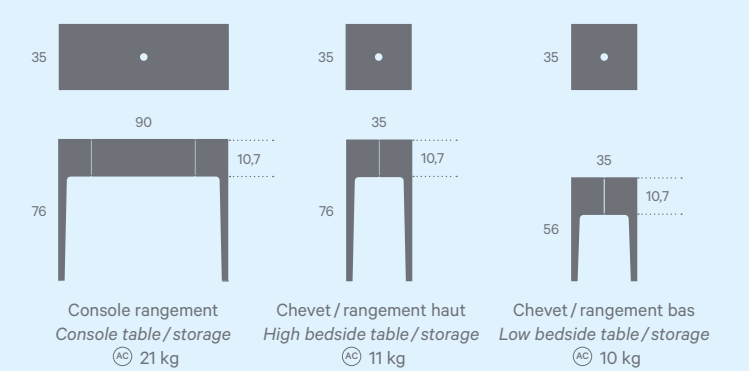

Perçage Ø 4 cm pour passage prise dans le plateau  
Hole for cables 4 cm in the top  
Ⓢ ✕

Flor

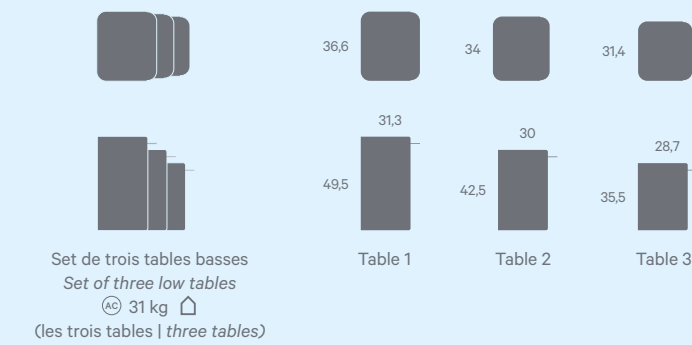

Galets

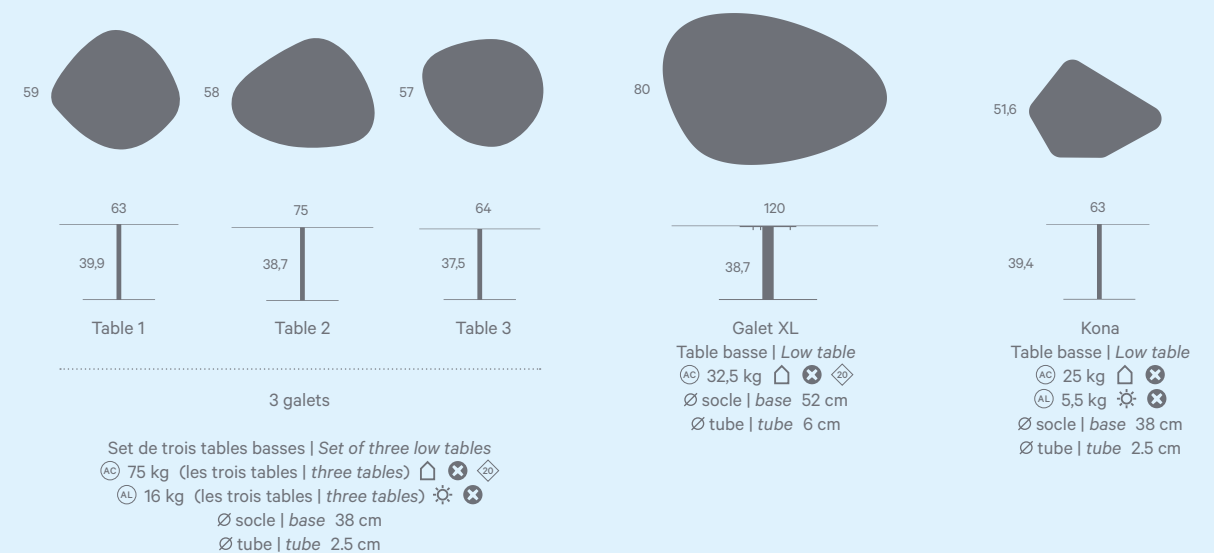

## Mistral

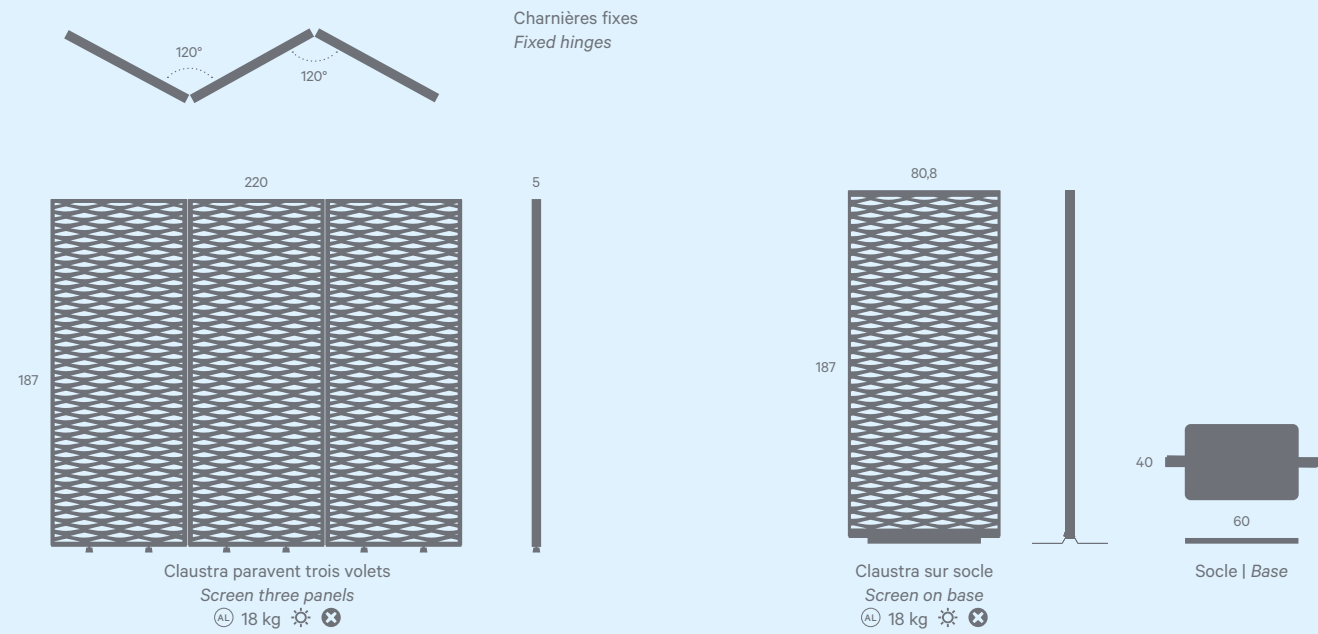

## Étagères | Shelves

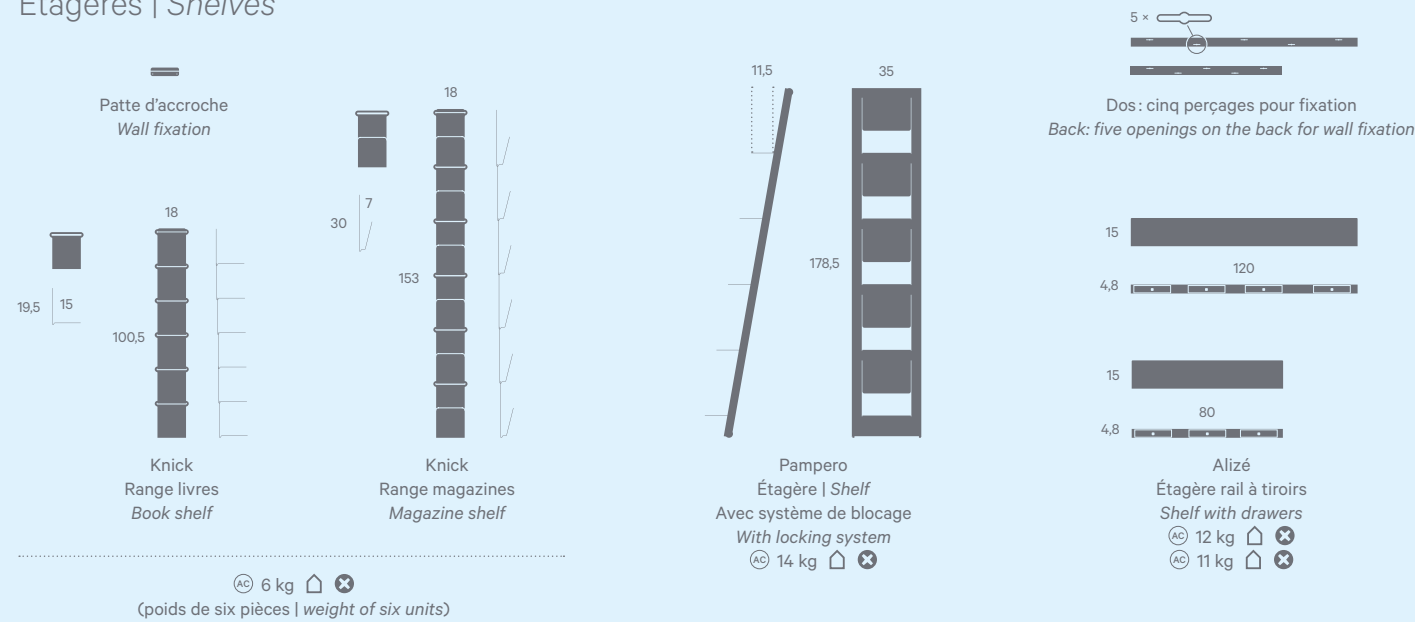

## Xlokk

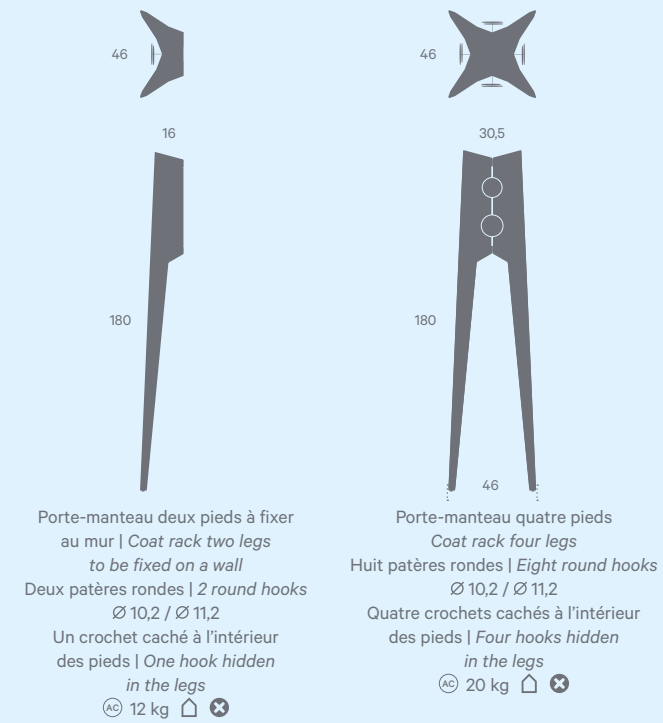

## Fleurs | Flowers

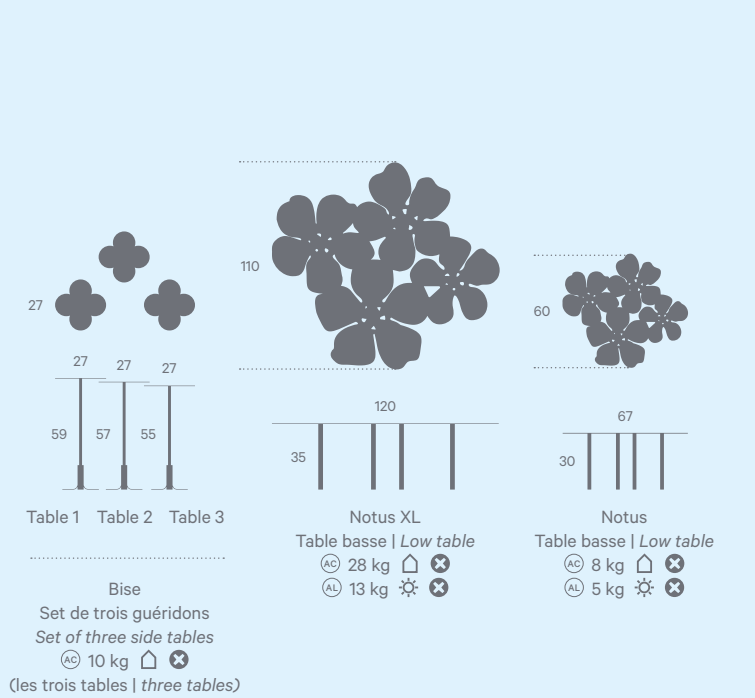

## Centres de table | Table centerpieces

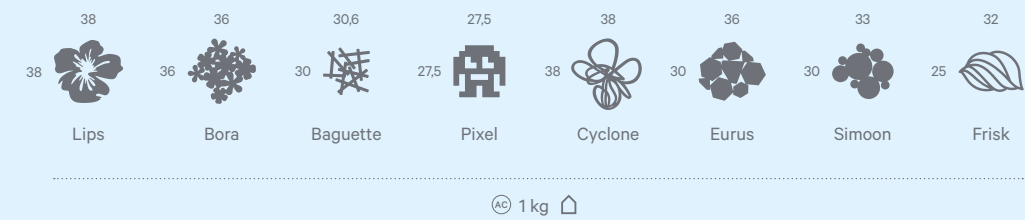

## Petit mobilier | Small furniture

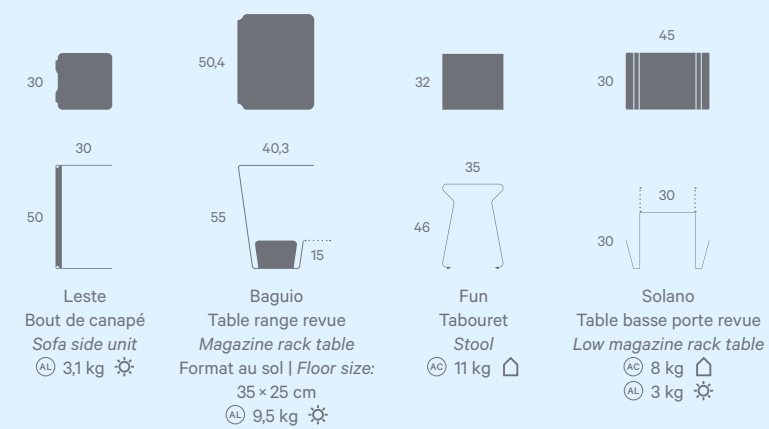

#### Remerciements

*Thank you for your help*  
Pierrick, Luc, Valérie, Léa,  
Pierre, Daphné, Amandine,  
Virginie / Villa Cap Arts.

#### Crédit photos | *Photo credit*

Pierrick Verny,  
à l'exception de | *except:*  
– page 7, photo 4 :  
Studio Dussouillez  
– page 20 : Charlotte Pierrot.  
Visuels détournés réalisés  
par les designers auteurs  
des produits | *Cropped images*  
*realized by the designers*  
*who created the products.*

#### Conception graphique

*Graphic design:* Trafik

#### Matière Grise™

Dessins et modèles déposés.  
© Toute reproduction interdite.  
Photos, coloris et données  
techniques non contractuels.  
*Drawings and models registred*  
*© Any reproduction forbidden.*  
*Pictures colors and technical*  
*information are not contractual.*

Catalogue imprimé en janvier  
2015 | *Printed in January 2015*

#### Liste des revendeurs et fiches

produits sur | *Retailers on*  
[www.matieregrise-decoration.fr](http://www.matieregrise-decoration.fr)

#### Contact | *Contact*

Matière Grise  
ZA de Charpenay  
172 rue de Charpenay  
69210 Lentilly  
France

T. +33 (0)4 78 34 95 28  
[contact@matieregrise-decoration.fr](mailto:contact@matieregrise-decoration.fr)



www  
. matieregrise  
- decoration  
. fr

