

FARCILOTTE

Étude de la charte graphique couleur

PROJET 2 : LA COULEUR

A) L'EMBLÈME :

Recherche d'une signature utilisable **seule** ou **avec** bannière.
Recherche autour de l'épée.

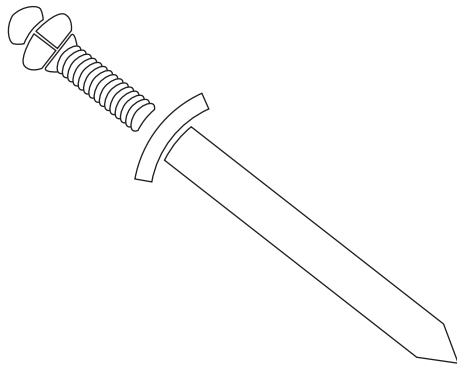

F

Le «F» de «Farciplotte»



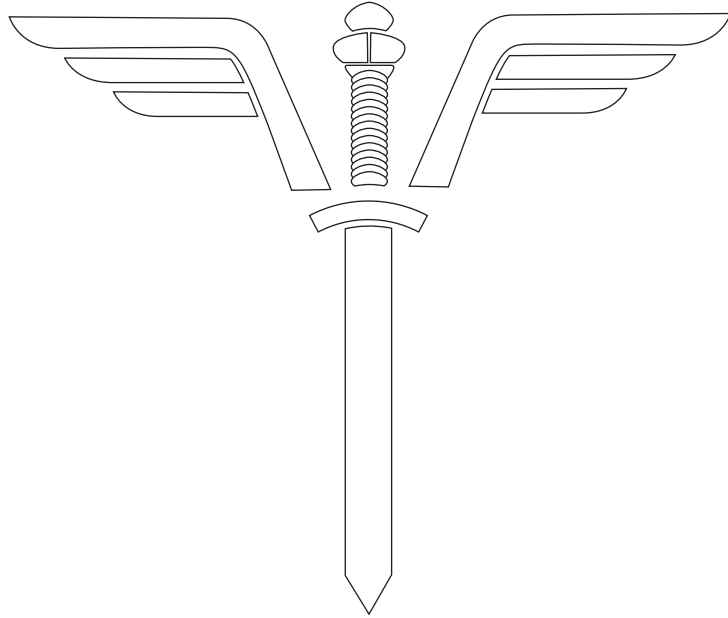

5A) Logo couleur : épée double F

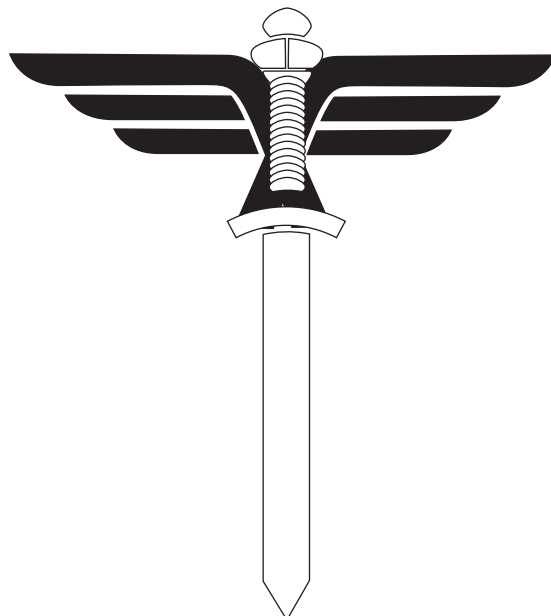

5B) Logo couleur : épée double F

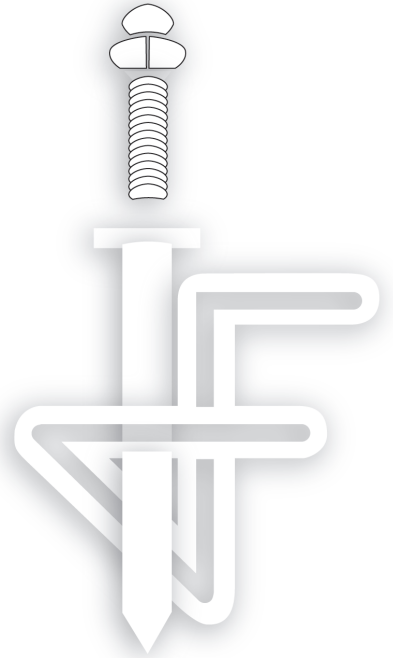
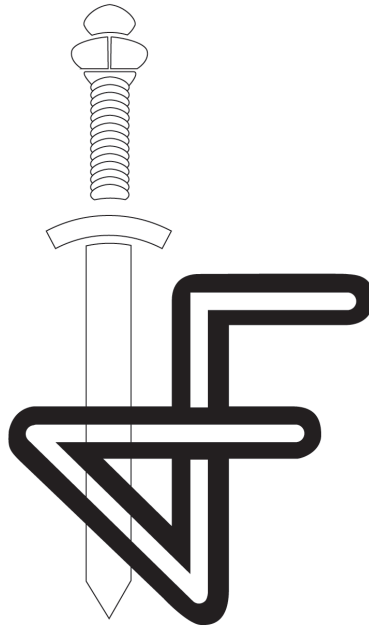
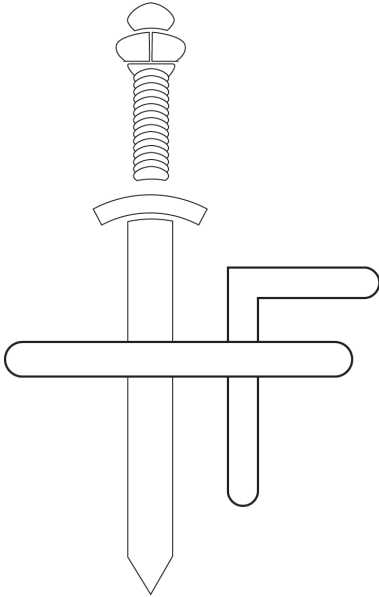
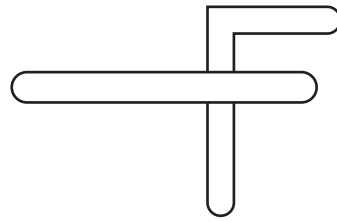

6A) Logo couleur : épée + ailes



6B) Logo couleur : épée + ailes blanches



6C) Logo couleur : épée + ailes blanches



6D) Logo couleur : épée + ailes tribales



7A) Logo couleur : épée + dragon



7B) Logo couleur : épée + dragon

La Farciplotte

B) LA BANNIÈRE :

Étude d'une image de fond facilement **dissociable** pour qu'elle puisse **changer** en fonction des événements annuels (Noël, pâques, ...)

